

This is a self-archived version of an original article. This version may differ from the original in pagination and typographic details.

Author(s): Kuznetsov, N.V.; Yuldashev, M.V.; Yuldashev, R.V.

Title: Analytical-numerical analysis of closed-form dynamic model of Sayano-Shushenskaya hydropower plant : stability, oscillations, and accident

Year: 2021

Version: Accepted version (Final draft)

Copyright: © 2020 Elsevier B.V. All rights reserved.

Rights: CC BY-NC-ND 4.0

Rights url: <https://creativecommons.org/licenses/by-nc-nd/4.0/>

Please cite the original version:

Kuznetsov, N.V., Yuldashev, M.V., & Yuldashev, R.V. (2021). Analytical-numerical analysis of closed-form dynamic model of Sayano-Shushenskaya hydropower plant : stability, oscillations, and accident. *Communications in Nonlinear Science and Numerical Simulation*, 93, Article 105530. <https://doi.org/10.1016/j.cnsns.2020.105530>

Journal Pre-proof

Analytical-numerical analysis of closed-form dynamic model of Sayano-Shushenskaya hydropower plant: stability, oscillations, and accident

N.V. Kuznetsov, M.V. Yuldashev, R.V. Yuldashev

PII: S1007-5704(20)30360-9
DOI: <https://doi.org/10.1016/j.cnsns.2020.105530>
Reference: CNSNS 105530

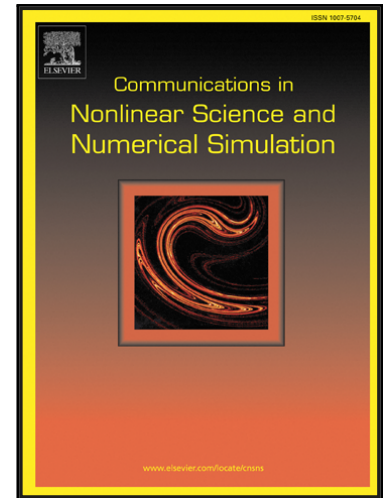

To appear in: *Communications in Nonlinear Science and Numerical Simulation*

Received date: 24 July 2015
Revised date: 28 June 2020
Accepted date: 6 September 2020

Please cite this article as: N.V. Kuznetsov, M.V. Yuldashev, R.V. Yuldashev, Analytical-numerical analysis of closed-form dynamic model of Sayano-Shushenskaya hydropower plant: stability, oscillations, and accident, *Communications in Nonlinear Science and Numerical Simulation* (2020), doi: <https://doi.org/10.1016/j.cnsns.2020.105530>

This is a PDF file of an article that has undergone enhancements after acceptance, such as the addition of a cover page and metadata, and formatting for readability, but it is not yet the definitive version of record. This version will undergo additional copyediting, typesetting and review before it is published in its final form, but we are providing this version to give early visibility of the article. Please note that, during the production process, errors may be discovered which could affect the content, and all legal disclaimers that apply to the journal pertain.

© 2020 Published by Elsevier B.V.

Highlights

- A mathematical model of hydropower plant is suggested.
- The accident happened on the Sayano-Shushenskaya hydropower plant in 2009 year is explained.

Journal Pre-proof

Analytical-numerical analysis of closed-form dynamic
model of Sayano-Shushenskaya hydropower plant:
stability, oscillations, and accident

Dedicated to G.A. Leonov (1947–2018)

N.V. Kuznetsov^{a,b,c}, M.V. Yuldashev^a, R.V. Yuldashev^a

^a*Faculty of Mathematics and Mechanics, St. Petersburg State University, 198504
Peterhof, St. Petersburg, Russia*

^b*Faculty of Information Technology, University of Jyväskylä,
40014 Jyväskylä, Finland*

^c*Institute for Problems in Mechanical Engineering RAS, Russia*

Abstract

This work is devoted to the analysis of a mathematical model of hydropower unit, consisting of synchronous generator, hydraulic turbine, and speed governor. It is motivated by the accident happened on the Sayano-Shushenskaya hydropower plant in 2009 year. In the analysis we follow the line of classical control theory approach developed in the works of famous scientists J.C. Maxwell, I.A. Vishnegradsky, A.A. Andronov, and F. Tricomi for the study of centrifugal turbine governor and electrical machines limit-load problem. It is shown that the occurrence of vibrations in the Sayano-Shushenskaya hydropower plant can be caused by nonlinear dynamics of the closed-form model.

Keywords: Sayano-Shushenskaya hydropower plant, hydropower unit, synchronous generator, hydraulic turbine, speed governor, simulation, oscillations

1. Introduction

Nowadays one of the most important source of electricity is the electric energy produced by hydroelectric facilities. According to [1], Norway gets

Email address: nkuznetsov239@gmail.com (N.V. Kuznetsov)

99% of its electric power from water, Brazil 84%, Austria 59%, Canada 58% and Russia 18%. Failures of hydropower plants cause loss of lives, major damage in the surrounding area, and serious economic consequences. In recent years, the accidents at the hydropower plants have become frequent (see, e.g., Bieudron Hydroelectric Power Station (Switzerland, 2000), Taum Sauk Hydroelectric Power Station (Missouri, USA, 2005), Sayano-Shushenskaya Dam (Russia, 2009), Itaipu Dam (Brazil, 2009), Srisailem Dam (India, 2013), Dhauliganga hydro electric station (India, 2013)). In order to prevent such accidents, it is necessary to investigate their causes.

This work is motivated by the accident happened on the Sayano-Shushenskaya hydropower plant in 2009. According to the act of a special commission of the *Russian Federal Environmental, Industrial and Nuclear Supervision Service*, immediately before the accident the power of the second hydropower unit was 475 MW at a head of 212 meters [2], i.e., it worked in the not recommended zone II (Fig. 1). Zone II is characterized by strong hydraulic turbine blows in flowing part and vibrations. For a normal operation it is recommended a power range, corresponding to the zone III in which the efficiency of turbines has a maximum value. Also operation is allowed in the zone I in which the dynamics is allowed, but the level of efficiency of the turbines are low. The operation in zone IV is not allowed. These work zones of hydropower unit of the Sayano-Shushenskaya hydropower plant were obtained by the full-scale test of hydropower units in the late 80s of 20th century and were published in the technical report “*Full-scale testing of turbines of Sayano-Shushenskaya hydropower plant with standard runner*” No. 1008 [3].

As a rule, for the analysis of vibrations in complex electromechanical systems often one of the following approaches is used: (1) For each components of the HPP a fairly complete mathematical model is derived. This model is described by partial differential equations and takes into account physical processes. The vibrations in such models are analysed numerically (physical engineering approach, see, e.g. [4]); (2) A mathematical model described by non-autonomous linear differential equations of the entire HPP, which allows to take into account external vibrations in individual components of the HPP, is derived. The response of the HPP to the vibrations is studied numerically or analyticallly (mechanical engineering approach, see, e.g. [5]); (3) A closed-form mathematical model of the entire HPP described by autonomous nonlinear differential equations is derived. Then, the birth of vibrations caused by the nonlinearity of the model is studied analytically or

numerically (control systems engineering approach). Here we follow the latter approach, which is based on classical works by J.C. Maxwell [6], I.A. Vishnegradsky [7], A.A. Andronov [8], and F. Tricomi [9] on the centrifugal turbine governor and limit-load problem of electrical machines (see also [10]).

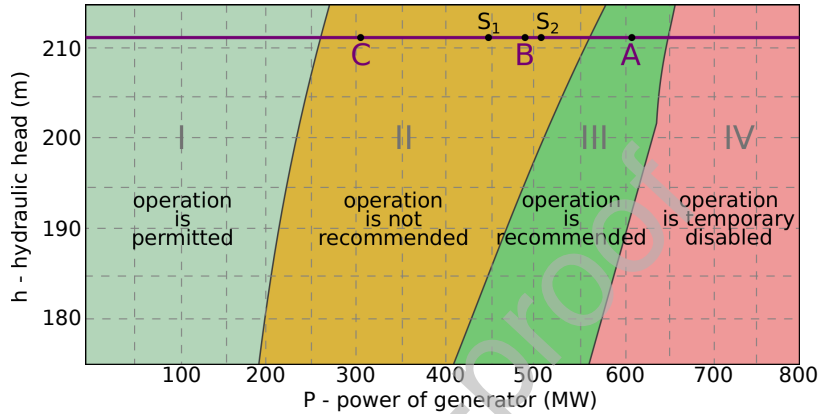

Figure 1: Operational zones of hydropower unit of the Sayano-Shushenskaya hydropower plant [3].

This paper is organized in the following way. In sections 2–6 a complete mathematical model of hydraulic power plant is considered. This model joins together differential equations of turbine, differential equations of synchronous generator (d-q model) [11, 12], and differential equations of speed governor [13]. The parameters of the model are taken from [14]. In section 8 the stability of steady state is analysed. In section 9 the transients are studied numerically¹.

Remark that more simple models of hydropower unit (based on more simple models of turbines (see [13]), synchronous generators (the Tricomi equation [9, 15], the equations of synchronous generator with parallel connection in feed system [15]) were also considered. However, for such models the above effects have not been found.

¹The Matlab code is uploaded to GitHub in the “hydro-ssh-cnscs” repository: <https://github.com/mir/hydro-ssh-cnscs>

2. Components of hydropower unit

Following [16], consider the main elements of hydro power plant unit in Fig. 2. The hydropower unit of Sayano-Shushenskaya HPP consists of synchronous generator and Francis hydraulic turbine. The rotor of generator and the runner are connected together by a rigid shaft.

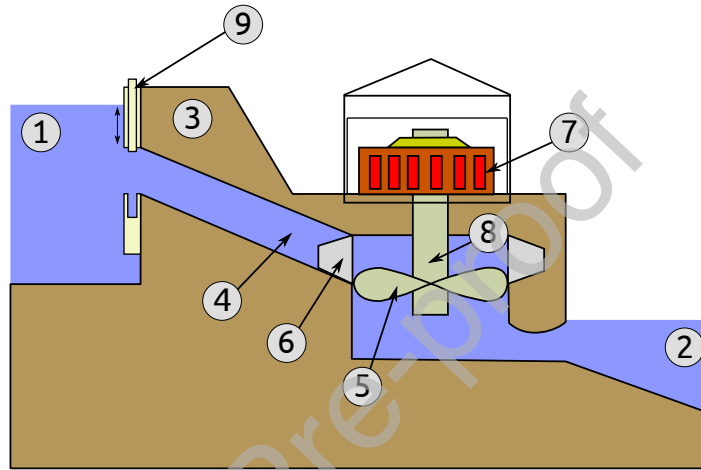

Figure 2: Scheme of the Sayano-Shushenskaya hydropower plant: 1 – upper reservoir, 2 – lower reservoir, 3 – dam, 4 – penstock, 5 – blade wheel, 6 – guide vanes, 7 – rotor of synchronous generator, 8 – shaft, 9 – control gate

The dam creates a difference in water level between the upper reservoir and lower reservoir. The flow of water is delivered from upper reservoir to turbine by penstock through the spiral casing. Water jets impact on the blades of the turbine producing torque applied to the rotating shaft. Since the turbine shaft is rigidly connected with the generator rotor, the rotor starts to rotate and to produce electricity, which is transferred to the grid. The water flow is controlled by means of guide vanes.

For the safety of the power network, the frequency should remain almost constant. This is reached by keeping the same speed of the synchronous generator. The rotational speed is controlled by the speed governor.

The main structural elements of hydropower unit are presented in Fig. 3. Introduce the following notations: s is a signal of angular (rotational) speed deviation, μ is a position of guide vanes, M_T is a turbine torque, M_G is a generator torque, U is a voltage required by the power network. The power network represents a set of energy suppliers and consumers.

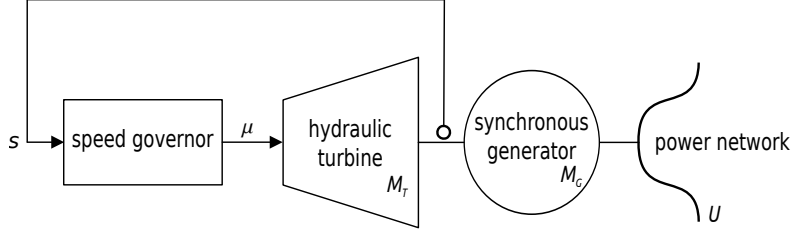

Figure 3: The main structural elements of hydropower unit

Thus, the hydropower unit represents a system consisting of hydraulic turbine, which produces a mechanical torque, generator, which converts mechanical energy into electrical energy, and automatic speed governor, which regulates the rotation speed of hydraulic turbine.

In order to develop a mathematical model of hydropower unit it is necessary to describe each structural element of hydropower unit, presented in Fig. 3. Let us consider each equations for each element.

3. Mathematical model of synchronous generator

Using Park's transformation, the three-phase windings of stator can be substituted by two equivalent short-circuited windings, and the rotor can be described as two equivalent short-circuited damper windings and one field winding. Thus, synchronous generator can be described by the Park-Gorev equations in per unit values [11, pp.132-149], [12, pp.5.15- 5.17]:

$$\begin{aligned}
 \dot{\Psi}_d &= -\omega_0(1+s)\Psi_q - \omega_0 r i_d - \omega_0 u_d, \\
 \dot{\Psi}_q &= \omega_0(1+s)\Psi_d - \omega_0 r i_q - \omega_0 u_q, \\
 \dot{\Psi}_r &= \frac{1}{T_r}(E_r - E_q), \\
 \dot{\Psi}_{rd} &= -\frac{1}{T_{rd}}E_{rq}, \\
 \dot{\Psi}_{rq} &= \frac{1}{T_{rq}}E_{rd},
 \end{aligned} \tag{1}$$

where flux linkages are determined as follows

$$\begin{aligned}
 \Psi_d &= x_d i_d + E_q + E_{rq}, \\
 \Psi_q &= x_q i_q - E_{rd}, \\
 \Psi_r &= \frac{x_{ad}^2}{x_r} i_d + E_q + \frac{x_{ad}}{x_r} E_{rq}, \\
 \Psi_{rd} &= \frac{x_{ad}^2}{x_{rd}} i_d + E_{rq} + \frac{x_{ad}}{x_{rd}} E_q, \\
 \Psi_{rq} &= \frac{x_{aq}^2}{x_{rq}} i_q - E_{rd}.
 \end{aligned} \tag{2}$$

Here the following variables and coefficients are relative to the corresponding base values (voltage, current, flux linkage, impedance, inductance, power): r is a stator resistance, i_d, i_q are currents in stator windings, u_d, u_q are stator voltages, $\Psi_d, \Psi_q, \Psi_r, \Psi_{rd}, \Psi_{rq}$ are flux linkages, E_r is a field voltage, E_q, E_{rd}, E_{rq} are electromotive forces, induced in the stator by the magnetic field of rotor winding currents for synchronous rotor speed, x_d, x_q are synchronous inductances (reactances) along the axes d and q , x_r, x_{rd}, x_{rq} are impedances of field winding, damper windings along the axes d and q , x_{ad}, x_{aq} are impedances of stator winding along the axes d and q . The following coefficients are time constants: T_r is a field-winding time constant with open stator and damper windings [s], T_{rd}, T_{rq} are damper winding time constants with open stator and field windings [s], ω_0 is a rated angular speed (synchronous speed) [rad/s].

The stator voltages u_d and u_q along the d- and q- axes in per unit values are determined according to the laws

$$u_d = -U \sin(\theta_0 + \theta_\Delta), \quad u_q = U \cos(\theta_0 + \theta_\Delta),$$

where $U = \frac{\hat{U}}{U_b}$ is a voltage relative to the base voltage [p.u.], \hat{U} is a voltage in power network [V], U_b is the base voltage [V].

The motion of synchronous generator rotor about shaft is described by the torque equation in physical values [11, pp.132-149], [12, pp.5.15-5.17]:

$$\begin{aligned}
 \dot{\theta}_\Delta &= \omega, \\
 J \dot{\omega} &= M_T - \left(\hat{\Psi}_d \hat{i}_q - \hat{\Psi}_q \hat{i}_d \right).
 \end{aligned} \tag{3}$$

Here J is a moment of inertia of rotor (is a moment of inertia of hydropower unit) [$\text{kg} \cdot \text{m}^2$], $\hat{\Psi}_d, \hat{\Psi}_q$ are flux linkages in physical unit values [$\text{Wb} = \frac{\text{kg} \cdot \text{m}^2}{\text{s}^2 \text{A}}$],

$\widehat{i}_d, \widehat{i}_q$ are currents in stator windings in physical unit values [A], M_T is the rotation torque [$\frac{\text{kg}\cdot\text{m}^2}{\text{s}^2}$]. Since the shaft of turbine is rigidly connected with the rotor of generator, a moment of inertia of rotor coincides with a moment of inertia of hydropower unit and an angular rotor speed coincides with an angular turbine speed. In our case the rotation torque M_T is a turbine torque, which is created by the pressure of water on the runner.

Rewrite system of equations (3) in terms of base variables. For this purpose the second equation is divided twice by the base voltage:

$$U_b = \omega_0 \Psi_b = Z_b I_b,$$

where Ψ_b is the base flux linkage [$\text{Wb} = \frac{\text{kg}\cdot\text{m}^2}{\text{s}^2\text{A}}$], Z_b is the base impedance (valid also for resistances and reactances)[Ohms], I_b is the base current [A]. Then

$$\frac{J}{\Psi_b Z_b I_b} \left(\frac{\dot{\omega}}{\omega_0} \right) = \frac{M_T}{\omega_0 \Psi_b Z_b I_b} - \frac{1}{\omega_0 Z_b} \left(\frac{\widehat{\Psi}_d \widehat{i}_q}{\Psi_b I_b} - \frac{\widehat{\Psi}_q \widehat{i}_d}{\Psi_b I_b} \right),$$

$$\frac{J \omega_0^2}{U_b I_b} \dot{s} = \frac{M_T}{\Psi_b I_b} - (\Psi_d i_q - \Psi_q i_d).$$

Thus, as a result of given transformation one obtains system of equations (3) in per unit values:

$$\begin{aligned} \dot{\theta}_\Delta &= \omega_0 s, \\ \dot{s} &= \frac{1}{T_J} \left(\frac{\widehat{M}_T}{\Psi_b I_b} - (\Psi_d i_q - \Psi_q i_d) \right), \end{aligned} \quad (4)$$

where $T_J = J \frac{\omega_0^2}{S_b}$ is inertial constant of hydropower unit [s], $S_b = U_b I_b$ is the base power [$\text{W} = \frac{\text{kg}\cdot\text{m}^2}{\text{s}^3}$].

4. Mathematical model of hydraulic turbine

Hydraulic turbines can be classified by their type of construction, the most important ones being the Francis, Pelton and Kaplan or Propeller turbines [1]. They are distinguished by construction of runner and control methods of the rotation speed of the turbine. The dynamics of hydraulic turbine can be described by equations

$$\dot{Q} = \frac{S}{l\rho} \left(p_u - p_l - \frac{Q^2}{C^2(\mu_0 + \mu_\Delta)^2} \right), \quad M_T = \frac{\widetilde{k}}{C^2(\mu_0 + \mu_\Delta)^2} \frac{Q^3}{\omega},$$

where S is a sectional area of penstock [m²], l_p is a length of penstock [m], ρ is a density of water [$\frac{\text{kg}}{\text{m}^3}$], p_u is a constant pressure on the upper end of penstock [Pa], p_l is a constant pressure on the lower end of penstock (after turbine) [Pa], μ_0 is a given position of guide vanes [p.u.], μ_Δ is the deviation of given position of guide vanes [p.u.], $C = S/\sqrt{\rho}$ is a constant depending on the construction of penstock [$\frac{\text{m}^3\sqrt{\text{m}}}{\sqrt{\text{kg}}}$], \tilde{S} is a sectional area of water conduit [m²], $\tilde{\rho}$ is the density of water [$\frac{\text{kg}}{\text{m}^3}$], \tilde{k} is a constant depending on the construction of turbine [p.u.], Q is the water flow through the turbine [$\frac{\text{m}^3}{\text{s}}$], and M_T is a turbine torque in the physical values.

Since for the description of dynamics of synchronous generator there are used equations in per unit values, we write the motion equation of turbine also in per unit values:

$$\dot{s} = \frac{1}{T_J} \left(\frac{k}{C^2(\mu_0 + \mu_\Delta)^2} \frac{Q^3}{\omega_0^2(1+s)} - \widetilde{M}_G \right),$$

where

$$k = \frac{\tilde{k}}{\Psi_b I_b}.$$

Note that the obtained system contains one control signal μ_Δ , which corresponds to automatic speed governor of turbine.

5. Mathematical model of speed governor

Let us consider the simplified scheme of automatic speed governor of turbine [13, pp.153-157], presented in Fig. 4. In this work parameters of hydropower unit are chosen so that the speed governor does not get to saturation. To simulate the case of saturation it is necessary to consider more complex models of speed governors (see, e.g., [17–21]).

The governor has the deadband z , which is specified by the technical conditions. The deadband of the hydraulic turbine is 30 mHz [13]. The deadband in the per unit values is $z = 0,002$.

The input signal is a relative deviation of rated angular speed s . After the input signal passes through the deadband, one obtains the signal η_s , which

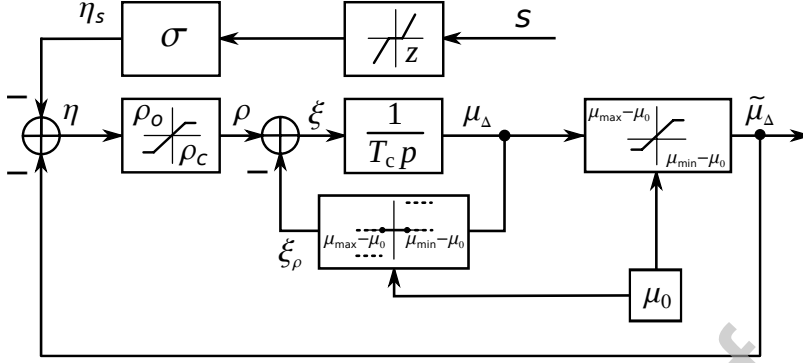

Figure 4: Scheme of automatic speed governor of hydraulic turbine

corresponds to a signal of measuring device:

$$\eta_s = \sigma \chi_s(s) = \begin{cases} \sigma(s - z/2), & s \geq z/2, \\ \sigma(s + z/2), & s \leq -z/2, \\ 0, & |s| < z/2, \end{cases}$$

where σ is a transmission coefficient of open-cycle control system.

The control signal η is formed by the formula

$$\eta = -\eta_s - \tilde{\mu}_\Delta,$$

where $\tilde{\mu}_\Delta$ is a signal of rigid negative feedback.

Then the control signal is cut off because of restriction on the velocity of change of guide vanes position:

$$\rho = \chi_\rho(\eta) = \begin{cases} \eta, & \rho_o \leq \eta \leq \rho_c, \\ \rho_o, & \eta < \rho_o, \\ \rho_c, & \rho_c < \eta, \end{cases}$$

where ρ_o, ρ_c are the maximum velocities of opening and closing the vanes.

A servomotor is presented by the integrator with time constant T_c [s]. The output value of servomotor is the relative displacement of guide vanes $\tilde{\mu}_\Delta$. The stroke of servomotor has limit stops μ_{min}, μ_{max} , which correspond to the minimum and maximum power of the turbine [13]. If guide vanes reach limit stops, at which further displacement of vanes in the same direction is not possible, then displacement of vanes is stopped. In some research works

[20–23] it is recommended to model such saturation through direct feedback, presented in Fig. 4 by the dashed line.

Consequently, the control signal takes the following form

$$\xi = \rho - \xi_\rho(\mu_\Delta, \mu_0),$$

where

$$\xi_\rho(\mu_\Delta, \mu_0) = \begin{cases} \rho, & \mu_\Delta + \mu_0 < \mu_{min} \text{ and } \rho < 0, \\ \rho, & \mu_\Delta + \mu_0 > \mu_{max} \text{ and } \rho > 0, \\ 0, & \text{otherwise.} \end{cases}$$

The equation of servomotor motion is as follows

$$\dot{\tilde{\mu}}_\Delta = \frac{\rho - \xi_\rho(\mu_\Delta, \mu_0)}{T_c}, \quad (5)$$

where

$$\tilde{\mu}_\Delta = \chi_\mu(\mu_\Delta, \mu_0) = \begin{cases} \mu_\Delta, & \mu_{min} - \mu_0 \leq \mu_\Delta \leq \mu_{max} - \mu_0, \\ \mu_{min} - \mu_0, & \mu_0 + \mu_\Delta < \mu_{min}, \\ \mu_{max} - \mu_0, & \mu_0 + \mu_\Delta > \mu_{max}. \end{cases}$$

In other words, the signal $\tilde{\mu}_\Delta$ is the signal μ_Δ , passed through the saturation. Consequently, equation (5) can be rewritten in the form

$$\dot{\mu}_\Delta = \frac{\rho - \xi_\rho(\mu_\Delta, \mu_0)}{T_c},$$

$$\mu_{min} - \mu_0 \leq \mu_\Delta \leq \mu_{max} - \mu_0.$$

Thus, the automatic speed governor of the turbine can be described by the following differential equation

$$\dot{\mu}_\Delta = \frac{\chi_\rho(-\sigma\chi_s(s) - \chi_\mu(\mu_\Delta, \mu_0) - \xi_\rho(\mu_\Delta, \mu_0))}{T_c}.$$

6. Complete mathematical model.

Using equations of each structural element of hydropower unit, one writes the equations of hydropower unit with automatic speed governor in per unit

values:

$$\begin{aligned}
 \dot{\theta}_\Delta &= \omega_0 s, \\
 \dot{s} &= \frac{1}{T_J} \left(\frac{k}{C^2(\mu_0 + \mu_\Delta)^2} \frac{Q^3}{\omega_0^2(1+s)} - \Psi_d i_q + \Psi_q i_d \right), \\
 \dot{Q} &= \frac{S}{l\rho} \left(p_u - p_l - \frac{Q^2}{C^2(\mu_0 + \mu_\Delta)^2} \right), \\
 \dot{\Psi}_d &= -\omega_0(1+s)\Psi_q - \omega_0 r i_d + \omega_0 U \sin(\theta_0 + \theta_\Delta), \\
 \dot{\Psi}_q &= \omega_0(1+s)\Psi_d - \omega_0 r i_q - \omega_0 U \cos(\theta_0 + \theta_\Delta), \\
 T_r \dot{\Psi}_r &= E_r - E_q, \\
 T_{rd} \dot{\Psi}_{rd} &= -E_{rq}, \\
 T_{rq} \dot{\Psi}_{rq} &= E_{rd}, \\
 \dot{\mu}_\Delta &= \frac{\chi_\rho (-\sigma \chi_s(s) - \chi_\mu(\mu_\Delta, \mu_0) - \xi_\rho(\mu_\Delta, \mu_0))}{T_c}, \\
 \Psi_d &= x_d i_d + E_q + E_{rq}, \\
 \Psi_q &= x_q i_q - E_{rd}, \\
 \Psi_r &= \frac{x_{ad}^2}{x_r} i_d + E_q + \frac{x_{ad}}{x_r} E_{rq}, \\
 \Psi_{rd} &= \frac{x_{ad}^2}{x_{rd}} i_d + E_{rq} + \frac{x_{ad}}{x_{rd}} E_q, \\
 \Psi_{rq} &= \frac{x_{aq}^2}{x_{rq}} i_q - E_{rd}.
 \end{aligned} \tag{6}$$

In the case of the steady-state stability of hydropower unit the turbine rotates with a constant angular speed ($s = 0$) and the generator produces the constant power. Such an operation mode of hydropower unit corresponds to a steady-state (operating) mode of power network.² Note that for computations the hydropower unit are often presented as a source of current or electromotive force, the power of which corresponds to a power of generator.

Dynamical stability of hydropower units is considered in terms of maintaining a given mode. This means that if sudden, significant changes of network mode arises, then after the transient processes the output power of hydropower unit must correspond to the required power. For example, after

²Some other load models are considered in [24, 25]

short circuits in one or more power lines, blackouts, changes of the external load, etc. Note that the hydropower unit in the considered processes can not be represented as a source of current or electromotive force since dynamical processes in this case have a significant effect both on a hydropower unit, and on the network mode.

An operating mode of hydropower unit corresponds to the asymptotically stable equilibrium point of system (6). The equilibrium points are the following

$$\begin{aligned}
 s^{\text{st}} &= 0 \quad (\text{i.e. } \omega_{\Delta}^{\text{st}} = 0), & \mu_{\Delta}^{\text{st}} &= 0, \\
 \theta_{\Delta}^{\text{st}} &= \text{const}, & Q^{\text{st}} &= C\mu_0\sqrt{p_u - p_l}, \\
 E_q^{\text{st}} &= E_r, & E_{rq}^{\text{st}} &= 0, & E_{rd}^{\text{st}} &= 0, \\
 i_d^{\text{st}} &= -\frac{x_q}{r^2 + x_d x_q} \left(-\frac{r}{x_q} U \sin \theta - U \cos \theta + E_r \right), \\
 i_q^{\text{st}} &= -\frac{r}{r^2 + x_d x_q} \left(-\frac{x_d}{r} U \sin \theta - U \cos \theta - E_r \right), \\
 \Psi_d^{\text{st}} &= x_d i_d + E_r, & \Psi_q^{\text{st}} &= x_q i_q, & \Psi_r^{\text{st}} &= \frac{x_{ad}^2}{x_r} i_d + E_r, \\
 \Psi_{rd}^{\text{st}} &= \frac{x_{ad}^2}{x_{rd}} i_d + \frac{x_{ad}}{x_{rd}} E_r, & \Psi_{rq}^{\text{st}} &= \frac{x_{aq}^2}{x_{rd}} i_q.
 \end{aligned}$$

The position of guide vanes μ_0 is defined from the following equation, which will be called the balance equation between the turbine and the generator torques:

$$M_T(\mu_0, \omega_0) = M_G(U, \theta_0), \quad (7)$$

where

$$\begin{aligned}
 M_T(\mu_0, \omega_0) &= \frac{kC(p_u - p_l)^{\frac{3}{2}}}{\omega_0^2} \mu_0, \\
 M_G(U, \theta) &= \frac{r(x_d - x_q)}{r^2 + x_d x_q} \left(-U^2 x_d \sin^2 \theta + U^2 x_q \cos^2 \theta - \right. \\
 &\quad \left. - \frac{r^2 - x_d x_q}{r} U^2 \sin \theta \cos \theta - E_r \frac{x_d x_q - r^2}{r} U \sin \theta + \right. \\
 &\quad \left. + 2x_q E_r U \cos \theta \right) - \frac{E_r}{r^2 + x_d x_q} \left(-x_d U \sin \theta + r U \cos \theta \right) + \\
 &\quad + \frac{r x_q E_r (x_d - x_q)}{(r^2 + x_d x_q)^2} - \frac{r E_r^2}{(r^2 + x_d x_q)}.
 \end{aligned}$$

Graphical solutions of the balance equation depending on voltage change in the power network are presented in Fig. 5. The parameter corresponding to the voltage is represented as $U = \gamma U_{nom}$, where $\gamma > 0$.

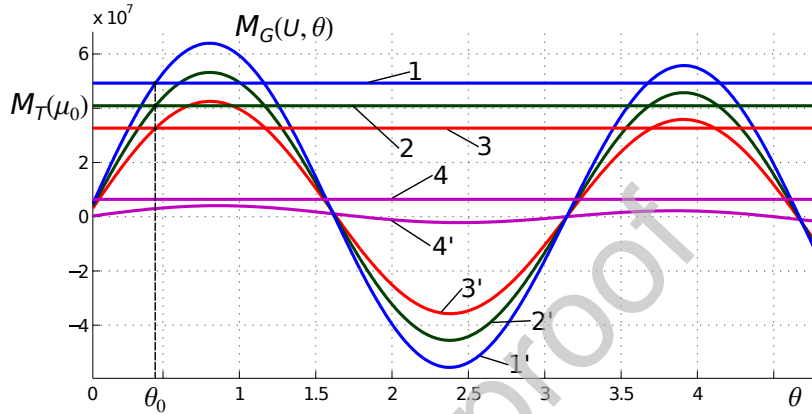

Figure 5: Graphical solution of the balance equation depending on U . Lines 1, 1' for $\gamma = 1$, lines 2, 2' for $\gamma = 0.9$, lines 3, 3' for $\gamma = 0.8$, lines 4, 4' for $\gamma = 0.1$

Equation (7) contains the input parameter U and the variable μ_0 . The equality of turbine and generator torques is attained due to the variable μ_0 . Recall that $\omega_0 = 14,954 \text{ rad/s}$, $\theta_0 = \arccos(0.9)$. Then μ_0 , depending on the voltage U , is found from the balance equation (7) of torques of turbine and generator. A plot of μ_0 against U is presented in Fig. 6.

For sufficiently large and small values of U , the parameter μ_0 falls on the saturation that corresponds to the limit position of guide vanes. In particular this mode corresponds to the start of hydropower unit. Then it is necessary to consider a more complex balance equation

$$M_T(\mu_0(U), \omega_0) = M_G(U, \theta_0 + \theta_\Delta),$$

and the balance will be achieved with help of θ_Δ , i.e. θ_Δ^{st} may not be equal to zero. In Fig. 7 a plot of $\theta = \theta_0 + \theta_\Delta$ against voltage U is shown.

If μ_0 does not fall on the saturation, then $\theta_\Delta^{st} = 2\pi k$. Otherwise, $\theta_\Delta^{st} = C + 2\pi k$, where $C = \text{const}$.

Since for $\mu_0 = \mu_{max}$ ($\mu_0 = \mu_{min}$) there are restrictions on θ , one can get again the saturation. In this case the balance will be achieved with the help of ω_Δ .

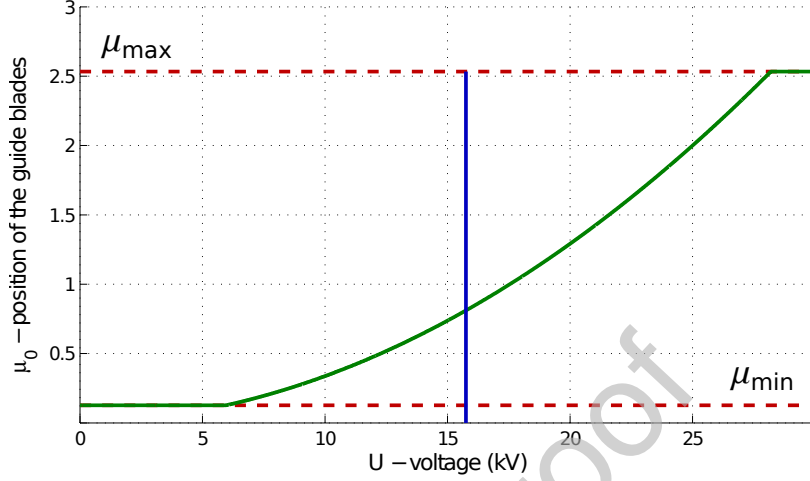
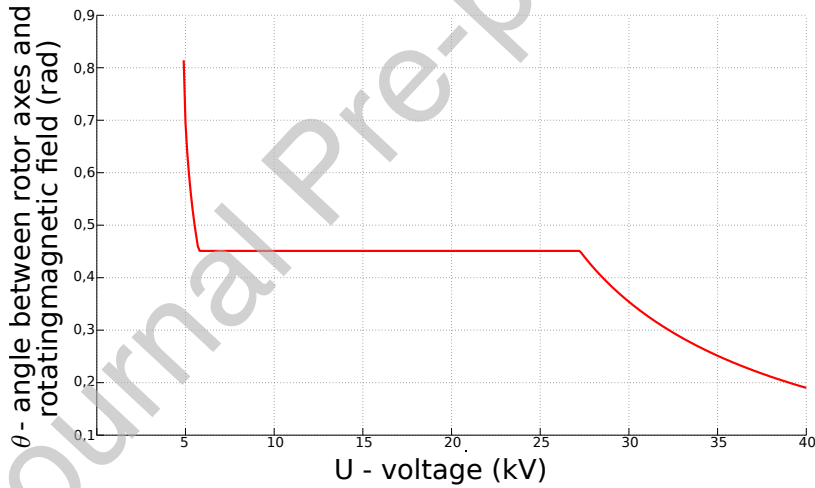
Figure 6: Plot of μ_0 against U , $k = 40$, $\theta_0 = \arccos(0.9)$ Figure 7: Plot of θ against U

However for the considered allowed voltage U the value $\mu_0(U)$ does not fall on the saturation, thus we do not consider the cases of achieving the balance with the help of θ_Δ and ω_Δ .

The instantaneous power is determined by the formula

$$P(U, \theta(t)) = -\frac{3}{2} (i_d(t)U \sin(\theta(t)) + i_q(t)U \cos(\theta(t))).$$

Represent the instantaneous power in the following form

$$P(U, \theta(t)) = P_0 + P_{\Delta}(U, \theta(t)),$$

where P_0 is the required (nominal) power, which is determined by the formula $P_0 = P(U, \theta_0)$, P_{Δ} is a deviation of the required power.

The change of U leads to the change of power. A plot of P against U is shown in Fig. 6.

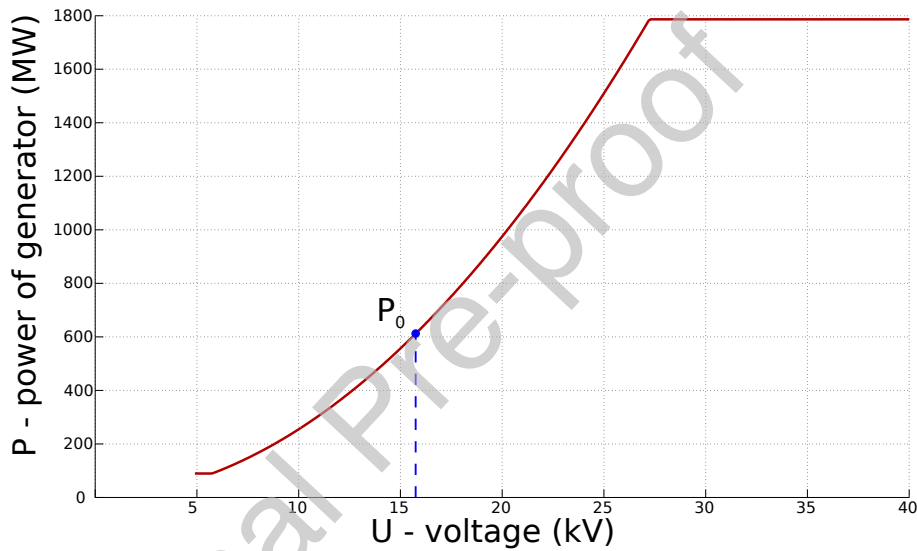

Figure 8: A plot of $P(U, \theta_0)$

7. Calculation of generator and turbine parameters for the Sayano-Shushenskaya hydropower plant

The radial-axial vertical hydraulic turbines RO-230/833-B-677, connected with synchronous generator on the umbrella type SVF-1285/275-42 UHL4, are installed at the Sayano-Shushenskaya hydropower plant.

The rest of the system parameters are determined as follows:

- Impedances of stator winding along the axis d : $x_{ad} = x_d - x_s = 1.396$,
- Impedances of stator winding along the axis q : $x_{aq} = x_q - x_s = 0.786$,
- Impedances of field winding: $x_r = \frac{x_{ad}^2}{x_d - x'_d} = 1.6946$,

Table 1: Parameters of synchronous generators (SVF-1285/275-42 UHL4) [14]

Parameter	Value
Rated angular speed, ω_0	142.8 [rad/s]
Stator resistance, r	0.0034 [p.u.]
Leakage inductive reactance of stator winding, x_s	0.184 [[p.u.]
Synchronous inductance along the axis d , x_d	1.58 [p.u.]
Synchronous inductance along the axis q , x_q	0.97 [p.u.]
Transient resistance, x'_d	0.43 [p.u.]
Sub-transient reactance along the axis d , x''_d	0.3 [p.u.]
Sub-transient reactance along the axis q , x''_q	0.31 [p.u.]
Time constant of field winding, T_r	8.21 [s]
Sub-transient time of field winding, T''_d	0.143 [s]
Moment of inertia, J	$25.5 \cdot 10^6$ [kg · m ²]
Field voltage, E_r	530 [V]
Stator voltage, U	15.75 [kV]

- Impedances of damper winding along the axis d : $x_{rd} = x_{ad} + \left(\frac{1}{x''_d - x_s} - \frac{1}{x_{ad}} - \frac{1}{x_{sr}} \right)^{-1} = 1.6155$,
- Impedances of damper winding along the axis q : $x_{rq} = x_{aq} + \left(\frac{1}{x''_q - x_s} - \frac{1}{x_{aq}} \right)^{-1} = 0.9361$,
- Resistance of field winding: $x_{sr} = x_r - x_{ad} = 0.2986$,
- Resistance of damper winding along the axis d : $r_{rd} = \frac{(x_{rd}x_d - x_{ad}^2)x_{rd}}{\omega_0 x_d x'_d T''_d} = 0.1246$,
- Resistance of damper winding along the axis q : $r_{rq} = \frac{x_{rq}x_q - x_{aq}^2}{\omega_0 x_q T''_q} = 0.0823$,

- Time constant of damper winding along the axis d : $T_{rd} = \frac{x_{rd}}{\omega_0 r_{rd}} = 0.8666$,
- Time constant of damper winding along the axis q : $T_{rq} = \frac{x_{rq}}{\omega_0 r_{rq}} = 0.7604$.

Table 2: Parameters of turbine (RO-230/833-B-677)

Parameter	Value
Length of penstock, l	212 [m]
Cross sectional diameter of penstock, D	7.5 [m]
Available water flow through turbine, Q_{nom}	358 [m ³ /s]

Thus, for modeling the parameters of hydropower unit of the Sayano-Shushenskaya hydropower plant were used ([14]): $\omega_0 = 2\pi 142.8/60$ [rad/s], $r = 0.0034$ [p.u.], $x_d = 1.58$ [p.u.], $x_q = 0.97$ [p.u.], $T_r = 8.21$ [s], $J = 25.5 \cdot 10^6$ [kg · m²], $E_r = 530$ [p.u.], $C = 0.27$ [m³√m/√kg], $x_{ad} = 1.396$ [p.u.], $x_{aq} = 0.786$ [p.u.], $x_r = 1.6946$ [p.u.], $x_{rd} = 1.6155$ [p.u.], $x_{rq} = 0.9361$ [p.u.], $T_{rd} = 0.8666$ [s], $T_{rq} = 0.7604$ [s], $S = \pi/4 \cdot 7.5^2$ [m²], $l = 192$ [m], $\rho = 0.98 \cdot 10^3$ [kg/m³], $p_u = 2.7 \cdot 10^6$ [Pa], $p_l = 0.35 \cdot 10^6$ [Pa], $k = 40$ [kg · m²/s²], $Q_{max} = 358$ [m³/s].

8. Local analysis

Let us study the local stability of equilibrium points of system (6). It is enough to carry out the analysis of stability on the interval $[0, 2\pi)$ since the solutions of the system are 2π -periodic. The equilibrium points with respect to θ are defined from balance equation (7). System (6) may have 0, 1, 2, 3 or 4 equilibrium points on the interval $[0, 2\pi)$.

Let us find the Jacobian matrix of the right-hand side of system (6). For this purpose algebraic system of equations (2) is solved for $i_d, i_q, E_q, E_{rd}, E_{rq}$:

$$\begin{aligned} i_d &= X_d \Psi_d - X_r \Psi_r + X_{rd} \Psi_{rd}, & i_q &= Y_q \Psi_q - Y_{rq} \Psi_{rq}, \\ E_q &= Z_d \Psi_d + Z_r \Psi_r - Z_{rd} \Psi_{rd}, & E_{rd} &= P_q \Psi_q - P_{rq} \Psi_{rq}, \\ E_{rq} &= -Q_d \Psi_d + Q_r \Psi_r + Q_{rd} \Psi_{rd}, \end{aligned}$$

where

$$X_d = \frac{a_4 a_6 - 1}{b_1}, \quad X_r = \frac{a_6 - 1}{b_1}, \quad X_{rd} = \frac{1 - a_4}{b_1},$$

$$\begin{aligned}
 Y_q &= \frac{1}{a_2 - a_7}, & Y_{rq} &= \frac{1}{a_2 - a_7}, \\
 Z_d &= \frac{(b_1 - (a_1 - a_5)(a_4 a_6 - 1))}{b_1(1 - a_6)}, & Z_r &= \frac{a_5 - a_1}{b_1}, \\
 Z_{rd} &= \frac{b_1 + (a_1 - a_5)(1 - a_4)}{b_1(1 - a_6)}, \\
 P_q &= \frac{a_7}{a_2 - a_7}, & P_{rq} &= \frac{a_2}{a_2 - a_7}, \\
 Q_d &= \frac{(a_1 - a_3)(a_4 a_6 - 1) - b_1}{(b_1(1 - a_4))}, \\
 Q_r &= \frac{(a_1 - a_3)(a_6 - 1) - b_1}{b_1(1 - a_4)}, & Q_{rd} &= \frac{a_3 - a_1}{b_1}, \\
 a_1 &= x_d, & a_2 &= x_q, & a_3 &= \frac{x_{ad}^2}{x_r}, & a_4 &= \frac{x_{ad}}{x_r}, \\
 a_5 &= \frac{x_{ad}^2}{x_{rd}}, & a_6 &= \frac{x_{ad}}{x_{rd}}, & a_7 &= \frac{x_{aq}^2}{x_{rq}}, \\
 b_1 &= (a_1 - a_5)(a_4 - 1) - (a_1 a_4 - a_3)(1 - a_6).
 \end{aligned}$$

Then nonzero elements of the Jacobi matrix

$$J = \{j_{i,k}\}_{k=1\dots 9}^{i=1\dots 9}$$

of the right-hand side of system (6) in stationary point are defined by the formulas:

$$\begin{aligned}
 j_{1,2} &= \omega_0, & j_{2,2} &= \frac{-k(Q^{st})^3}{T_J C^2 \omega_0^2 \mu_0^2}, & j_{2,3} &= \frac{3k(Q^{st})^2}{T_J C^2 \omega_0^2 \mu_0^2}, \\
 j_{2,4} &= \frac{(X_d - Y_q)\Psi_q + Y_{rq}\Psi_{rq}}{T_J}, \\
 j_{2,5} &= \frac{-Y_q\Psi_d + X_d\Psi_d - X_r\Psi_r + X_{rd}\Psi_{rd}}{T_J}, \\
 j_{2,6} &= \frac{-X_r\Psi_q}{T_J}, & j_{2,7} &= \frac{X_{rd}\Psi_q}{T_J}, & j_{2,8} &= \frac{Y_{rq}\Psi_d}{T_J}, \\
 j_{2,9} &= \frac{2k(Q^{st})^3}{T_J C^2 \mu_0^3 \omega_0^2}, & j_{3,3} &= -\frac{2S Q^{st}}{l\rho C^2 \mu_0^2},
 \end{aligned}$$

$$\begin{aligned}
 j_{3,9} &= -\frac{2S(Q^{st})^2}{l\rho C^2\mu_0^3}, & j_{4,1} &= \omega_0 U \cos(\theta_0 + \theta_\Delta^{st}), \\
 j_{4,2} &= -\omega_0 \Psi_q, & j_{4,4} &= -\omega_0 r X_d, & j_{4,5} &= -\omega_0 \\
 j_{4,6} &= \omega_0 r X_r, & j_{4,7} &= -\omega_0 r X_{rd}, \\
 j_{5,1} &= \omega_0 U \sin(\theta_0 + \theta_\Delta^{st}), & j_{5,2} &= \omega_0 \Psi_d, \\
 j_{5,4} &= \omega_0, & j_{5,5} &= -\omega_0 r Y_q, & j_{5,8} &= \omega_0 r Y_{rq}, \\
 j_{6,4} &= -\frac{Z_d}{T_r}, & j_{6,6} &= -\frac{Z_r}{T_r}, & j_{6,7} &= \frac{Z_{rd}}{T_r}, \\
 j_{7,4} &= \frac{Q_d}{T_{rd}}, & j_{7,6} &= -\frac{Q_r}{T_{rd}}, & j_{7,7} &= -\frac{Q_{rd}}{T_{rd}}, \\
 j_{8,5} &= \frac{P_q}{T_{rq}}, & j_{8,8} &= -\frac{P_{rq}}{T_{rq}}, & j_{9,2} &= \frac{1}{T_c}, & j_{9,9} &= -\frac{1}{T_c}.
 \end{aligned}$$

In order to study the local stability of the equilibrium states of system (6) relative to the voltage, the standard function *lsqnonlin* of the application package MATLAB was used³ This function is based on the least-squares method, i.e. on an iterative approximation to equilibrium state, that allows one to reduce the computational error and to define more exactly the interval of instability of the system. The initial data for this method is putative equilibrium state. Using this method the Jacobi matrix calculated at an equilibrium is found, and then the Routh–Hurwitz stability criterion is applied. Results are presented in Fig. 9: the equilibrium state $\theta = \theta_0$ is unstable for $\gamma \in [\gamma_1 \approx 0.86; \gamma_2 \approx 0.9]$ and stable for other γ , the rest three equilibria states are always unstable.

³First, the study of local stability of equilibria was carried out via eigenvalues of the Jacobian matrix and the standard function *eig* from MATLAB. It turned out that all equilibrium states are unstable for all γ . Further, the stability criterion of Routh–Hurwitz for the Jacobian matrix was applied. It showed that the equilibrium state $\theta = \theta_0$ is unstable for $\gamma \in [\gamma_1 \approx 0.84; \gamma_2 \approx 1.17]$ and stable for other γ . The obtained results of these methods can be explained by the fact that all calculations are made with some numerical error and because of the substantial difference in magnitude.

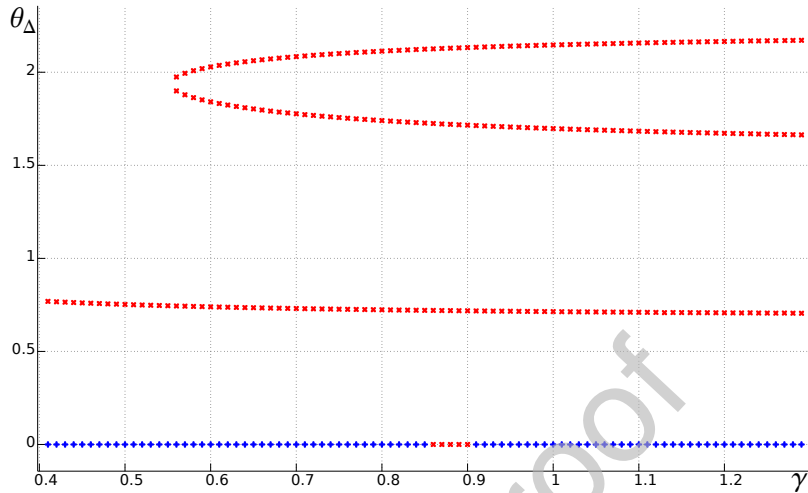

Figure 9: Stability of equilibrium states of system (6), defined by the least-squares method: blue pluses are stable equilibrium states, red crosses are unstable equilibrium states

9. Analysis of transient processes

During the operation of hydropower unit the transient processes related to sudden changes of the work parameters of the hydraulic unit often occur. As a result, the following problem arises: to find parameters, under which the hydropower unit pulls in the new operating mode after transient processes. This problem is closely related to the limit (ultimate) load problem, which arises in practice of operation of electrical motors after sudden change of load torque on the shaft [26–31]. For its solution the equal-area method is widely used in engineering practice. This method was used for some models in the works of A.A. Yanko-Trinitskii [27]. In our work modern methods of numerical integration of the system (Runge–Kutta method) are combined with the analysis in the spirit of the classical ideas of Yanko–Trinitskii.

First the numerical analysis of transient processes was carried out with the initial data taken from a small neighborhood of the equilibrium state. It is verified whether the trajectory goes out from this neighborhood after a long integration time (1000 s) or not. As a result of the study it was obtained that the equilibrium state $\theta = \theta_0$, corresponding to the operating mode, is unstable for $\gamma \in [\gamma_1 \approx 0.85; \gamma_2 \approx 0.91]$. The received interval of instability is consistent with the local analysis and corresponds to the interval $[S_1, S_2]$ in

Fig. 1. It can be defined more exactly due to coefficient k , corresponding the turbine used at the Sayano-Shushenskaya hydropower plant.

Further, the numerical analysis of transient processes was carried out with various initial data. For values γ , corresponding the local stability, hidden oscillations⁴ are not found numerically and all simulated trajectories attract to the equilibrium states. For values γ , corresponding to the local instability, simulated trajectories attract to self-excited periodic solutions. The local bifurcation, in which an equilibrium loses stability and a small stable limit cycle is born, occurs in considered multidimensional system.

According to [2], immediately before the accident the power of the second hydropower unit was 475 MW at a head of 212 meters (i.e., it worked in the not recommended zone II (Fig. 1). On the day of the accident the power of the second hydropower unit was reduced in accordance with the commands of the group controller of active and reactive power.

Below three cases are modeled:

1. operation of hydropower unit at the rated voltage (Fig. 1, point A) with initial data

$$(\theta_{\Delta}, s, Q, \Psi_d, \Psi_q, \Psi_r, \Psi_{rd}, \Psi_{rq}, \mu_{\Delta}) = (0, 1, 0, 0, 0, 0, 0, 0, 0),$$
2. reducing the power of hydropower unit, that corresponds to reducing voltage to 0.89 of the rated voltage (Fig. 1, point B),

⁴An oscillation can generally be easily numerically localized if the initial data from its open neighborhood in the phase space lead to a long-term behavior that approaches the oscillation. Therefore, from a computational perspective, it is natural to suggest the following classification of attractors [10, 32, 33], which is based on the simplicity of finding their basins of attraction in the phase space: *An attractor is called a self-excited attractor if its basin of attraction intersects with any open neighborhood of an equilibrium, otherwise it is called a hidden attractor.* For a *self-excited attractor* its basin of attraction is connected with an unstable equilibrium and, therefore, (*standard computational procedure*) self-excited attractors can be localized numerically by the *standard computational procedure*: by constructing a solution using initial data from an unstable manifold in a neighborhood of an unstable equilibrium, and observing how it is attracted, and visualizing the oscillation. In contrast, the basin of attraction for a hidden attractor is not connected with any equilibrium. For example, hidden attractors are attractors in systems with no equilibria or with only one stable equilibrium (a special case of the multistability: coexistence of attractors in multistable systems). Well known examples of the hidden oscillations are nested limit cycles in 16th Hilbert problem (see, e.g., [32, 34, 35]) and counterexamples to the Aizerman and Kalman conjectures on the absolute stability of nonlinear control systems [32, 36–38]. Hidden oscillations in the models of electrical machines are discussed, e.g., in [32, 39–42]

3. reducing power of hydropower unit, that corresponds to reducing voltage to 0.7 of the rated voltage (Fig. 1, point C).

The results of modeling have shown that at the rated voltage the trajectory of the system after transient processes is attracted to the equilibrium state, which corresponds to operating mode of hydropower unit (Figs. 10, 11). Further at some instant the voltage is reduced to 0.89 of the rated voltage. In this case the trajectory of the system after transient processes is attracted to the stable limit cycle (Figs. 12, 13), i.e., vibrations are arisen in the hydropower units. Then the voltage is reduced to 0.7 of the rated voltage. The trajectory of the system after transient processes is attracted to equilibrium state (Figs. 14, 15).

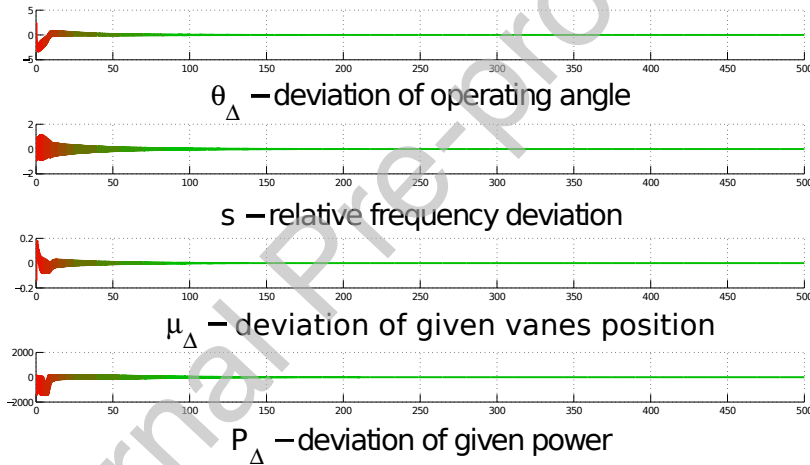

Figure 10: Stable equilibrium in the mathematical model of hydropower unit, $U = 15.75 \cdot 10^3$ [V]

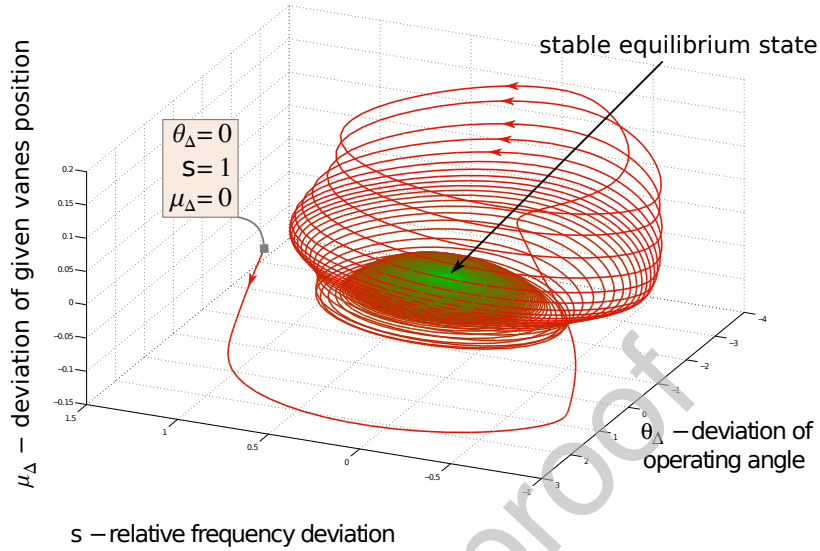

Figure 11: Stable equilibrium in the mathematical model of hydropower unit – projection onto $(\theta_{\Delta}, \mu_{\Delta}, s)$, $U = 15.75 \cdot 10^3$ [V]

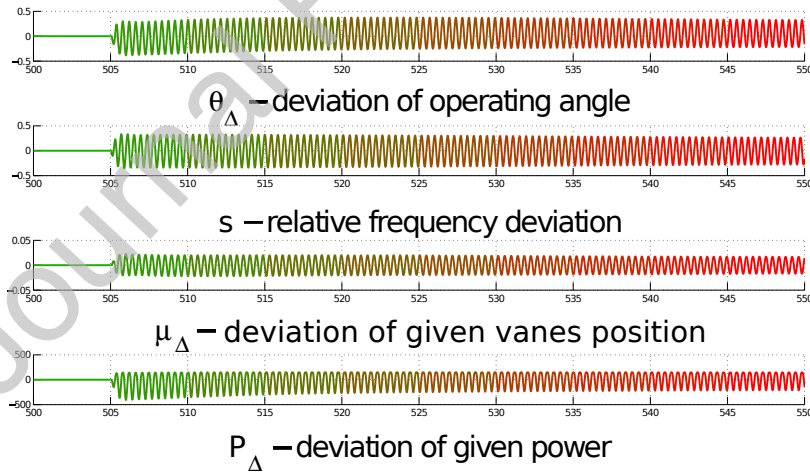

Figure 12: Limit cycle in the mathematical model of hydropower unit, $U = 0.89 \cdot 15.75 \cdot 10^3$ [V]

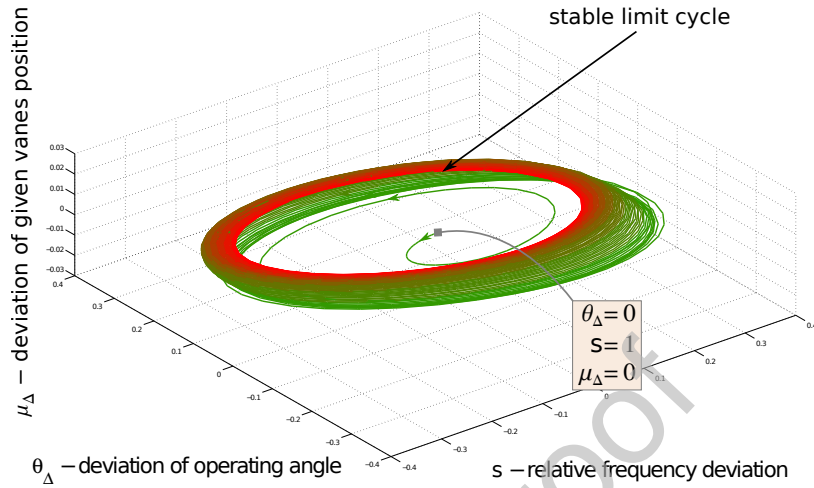

Figure 13: Limit cycle in the mathematical model of hydropower unit – projection onto $(\theta_{\Delta}, \mu_{\Delta}, s)$, $U = 0.89 \cdot 15.75 \cdot 10^3$ [V]

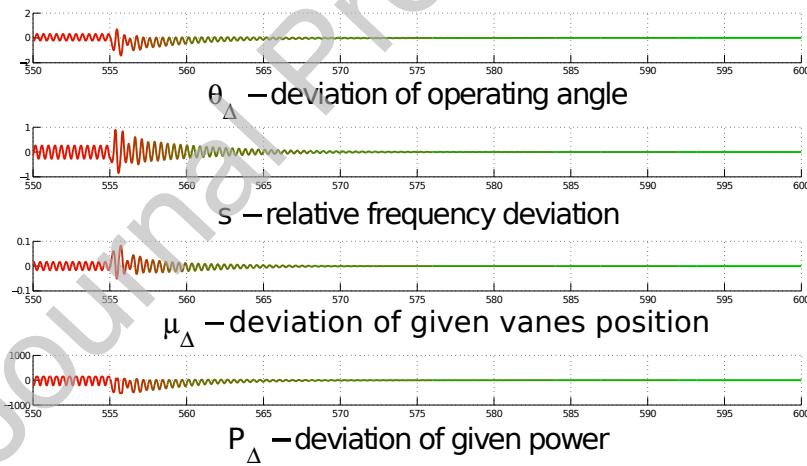

Figure 14: Stable equilibrium in the mathematical model of hydropower unit, $U = 0.7 \cdot 15.75 \cdot 10^3$ [V]

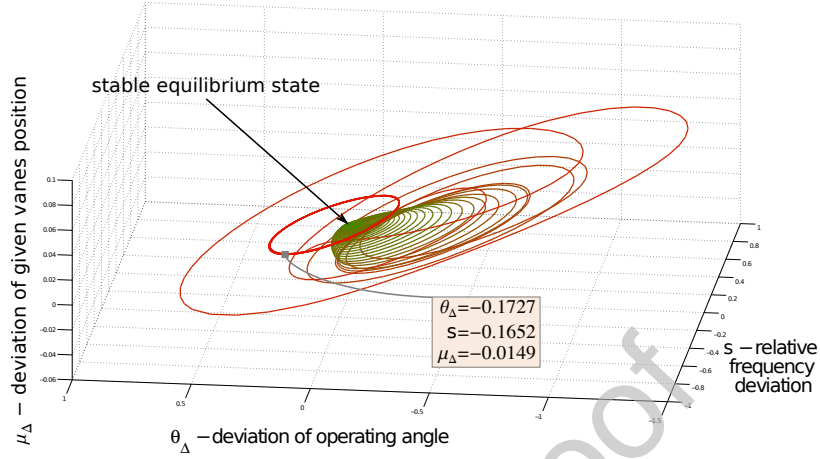

Figure 15: Stable equilibrium in the mathematical model of hydropower unit – projection onto $(\theta_{\Delta}, \mu_{\Delta}, s)$, $U = 0.7 \cdot 15.75 \cdot 10^3$ [V]

From Fig. 9, it is clear that the maximum value of the oscillation amplitude is reached at $U = 0.89U_{nom}$.

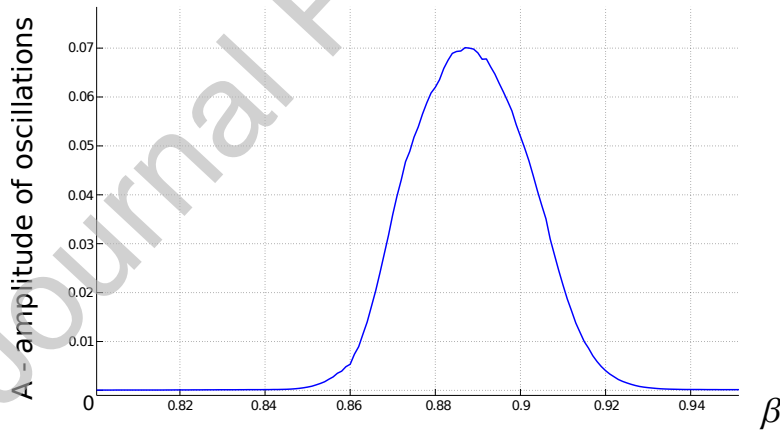

Figure 16: Amplitude of oscillations for different voltages $U = \beta U_{nom}$ (β - percent of capacity)

Thus, the results of modeling are sufficiently consistent with the full-scale tests carried out for hydropower units of the Sayano-Shushenskaya hydropower plant.

10. Conclusions

In this work we study the stability and demonstrate the birth of oscillations for a closed-form nonlinear mathematical model of the Sayano-Shushenskaya hydropower plant. The study follows the line of the classical control theory approach for analysis of such systems developed by famous academicians J.C. Maxwell, I.A. Vishnegradsky, A.A. Andronov, and F. Tricomi.

This work was motivated by the accident happened on the Sayano-Shushenskaya hydropower plant in 2009 year. The need for analysis of the occurrence of vibrations, caused by nonlinearity of the HPP model, and problems in the control system was discussed at a conference organized by the RusHydro company, which is the operator of the Sayano-Shushenskaya HPP [43]. The occurrence of vibrations due to the nonlinearity of the entire model, shown in this paper, complements other reasons of vibrations at the Sayano-Shushenskaya HPP discussed at the meeting of the Department of Energy, Engineering, Mechanics and Control Processes of the Russian Academy of Sciences [44]. Demonstrated examples of the occurrence of vibrations have to be taken into account for further development of the Sayano-Shushenskaya hydropower plant control systems.

Acknowledgements

This work was supported by Russian Science Foundation project 19-41-02002 (sections 1-8) and the Leading Scientific Schools project NSh-2624.2020.1 (sections 9-10). Authors would also like to thank E.P. Solovyeva for participation in the preparation of initial manuscript draft. We dedicate this paper to the memory of Gennady A. Leonov (1947-2018), with whom we started this work.

References

- [1] H.-J. Wagner, J.Mathur, Introduction to Hydro Energy Systems: Basics, Technology and Operatio, Springer Science & Business Media, 2011.
- [2] Rostechnadzor, The act of technical investigation into the causes of accident, occured on august 17, 2009 in the branch of the open joint-stock company "RusHydro" - "Sayano-Shushenskaya GES P. S. Neporozneg", Tech. rep. (2009).

- [3] V. Gluhih, Full-scale tests of turbines of the Sayano-Shushenskaya hydro power plant with standard runners, Tech. Rep. No. 1008 (1988).
- [4] R. Li, C. Li, X. Peng, W. Wei, Electromagnetic vibration simulation of a 250-mw large hydropower generator with rotor eccentricity and rotor deformation, *Energies* 10 (12) (2017) 2155.
- [5] R. Ganiev, Nonlinear resonances and disasters. Reliability, safety and noiselessness, Regular and chaotic dynamics, Moscow, Izhevsk, 2013 (in Russian).
- [6] J. Maxwell, On governors, *Proceedings of the Royal Society of London* (16) (1868) 270–283.
- [7] I. Vyshnegradsky, On regulators of direct action, *Izvestiya St. Petersburg Technological Inst.* (in Russian) 1 (1877).
- [8] A. Andronov, A. Maier, The Vyshnegradky problem in the theory of direct control, *Dokl. Akad. Nauk SSSR* (In Russian) 47 (5) (1945) 345–348.
- [9] F. Tricomi, Sur une equation differentielle de l'electrotechnique, *C.R. Acad. Sci. Paris*. T. 193 (1931).
- [10] N. Kuznetsov, Theory of hidden oscillations and stability of control systems, *Journal of Computer and Systems Sciences International* 59 (5) (2020) 647–668. doi:10.1134/S1064230720050093.
- [11] B. Adkins, *The General Theory of Electrical Machines*, Chapman & Hall, London, 1962.
- [12] I. Boldea, *Synchronous generators*, CRC Press, 2006.
- [13] G. Merkur'ev, Y. Shargin, *Stability of power systems*, NOU CPKE, Saint-Petersburg, 2008.
- [14] I. Karapetyan, D. Faibisovich, I. Sharipo, *Handbook for designing electrical networks*, Litres, 2013.
- [15] G. A. Leonov, N. V. Kondrat'eva, *Stability analysis of electric alternating current machines*, SPb: Isd. St. Petersburg. univ, 2009.

- [16] G. Leonov, N. Kuznetsov, E. Solovyeva, A simple dynamical model of hydropower plant: stability and oscillations, *IFAC-PapersOnLine* 48 (11) (2015) 656–661. doi:10.1016/j.ifacol.2015.09.262.
- [17] N. Bondareva, D. Kolotovkin, R. Cherkaoui, A. Germond, A. Grobovoy, M. Stubbe, Comparison of the results of full-scale experiment and long term dynamics simulation in the siberian interconnected power system, in: *Proc. IREP Symposium, Bulk Power System Dynamics and Control-VI*, 2004, pp. 492–498.
- [18] C. Nicolet, B. Greiveldinger, J.-J. Hérou, B. Kawkabani, P. Allenbach, J.-J. Simond, F. Avellan, High-order modeling of hydraulic power plant in islanded power network, *Power Systems, IEEE Transactions on* 22 (4) (2007) 1870–1880.
- [19] M. Sattouf, Simulation model of hydro power plant using matlab/simulink, *Journal of Engineering Research and Applications* 4 (1) (2014) 295–301.
- [20] S. Tarbouriech, G. Garcia, J. Gomes da Silva Jr., I. Queinnec, *Stability and Stabilization of Linear Systems with Saturating Actuators*, Springer-Verlag, London, 2011.
- [21] S. Tarbouriech, M. Turner, Anti-windup design: an overview of some recent advances and open problems, *IET Control Theory Appl.* 3 (1) (2009) 1–19.
URL <https://ira.le.ac.uk/handle/2381/4813>
- [22] S. Galeani, S. Onori, A. R. Teel, L. Zaccarian, A magnitude and rate saturation model and its use in the solution of a static anti-windup problem, *Systems & Control letters* 57 (1) (2008) 1–9.
- [23] L. Zaccarian, A. Teel, *Modern Anti-windup Synthesis: Control Augmentation for Actuator Saturation*, Princeton University Press, 2011.
- [24] G. Leonov, N. Kuznetsov, E. Solovyeva, Mathematical modeling of vibrations in turbogenerator sets of Sayano-Shushenskaya hydroelectric power station, *Doklady Physics* 61 (2) (2016) 55–60.

- [25] G. Leonov, N. Kuznetsov, B. Andrievsky, M. Yuldashev, R. Yuldashev, Mathematical modeling of transients of the hydraulic unit of the Sayano-Shushenskaya HPP, *Differencialnie Uravnenia i Protsesy Upravlenia (Differential Equations and Control Processes)* (4) (2018) 80–106.
- [26] F. A. Annett, *Electrical machinery: a practical study course on installation, operation and maintenance*, McGraw-Hill, 1950.
- [27] A. A. Yanko-Trinitskii, *New method for analysis of operation of synchronous motor for jump-like loads* [in Russian], M.-L.: GEI, 1958.
- [28] M. H. Haque, Further developments of the equal-area criterion for multimachine power systems 33(3) (1995) 175–183.
- [29] J. C. Das, *Power system analysis: short-circuit load flow and harmonics*, CRC Press, 2002.
- [30] N. Bianchi, *Electrical machine analysis using finite elements*, CRC Press, 2005.
- [31] G. Leonov, N. Kondrat'eva, *Stability analysis of electric alternating current machines* [in Russian], SPb: Isd. St. Petersburg. univ, 2009.
- [32] G. Leonov, N. Kuznetsov, Hidden attractors in dynamical systems. From hidden oscillations in Hilbert-Kolmogorov, Aizerman, and Kalman problems to hidden chaotic attractors in Chua circuits, *International Journal of Bifurcation and Chaos in Applied Sciences and Engineering* 23 (1), art. no. 1330002 (2013). doi:10.1142/S0218127413300024.
- [33] G. Leonov, N. Kuznetsov, T. Mokaev, Homoclinic orbits, and self-excited and hidden attractors in a Lorenz-like system describing convective fluid motion, *The European Physical Journal Special Topics* 224 (8) (2015) 1421–1458. doi:10.1140/epjst/e2015-02470-3.
- [34] N. Kuznetsov, O. Kuznetsova, G. Leonov, Visualization of four normal size limit cycles in two-dimensional polynomial quadratic system, *Differential equations and dynamical systems* 21 (1-2) (2013) 29–34. doi:10.1007/s12591-012-0118-6.
- [35] D. Dudkowski, S. Jafari, T. Kapitaniak, N. Kuznetsov, G. Leonov, A. Prasad, Hidden attractors in dynamical systems, *Physics Reports* 637 (2016) 1–50. doi:10.1016/j.physrep.2016.05.002.

- [36] G. Leonov, V. Bragin, N. Kuznetsov, Algorithm for constructing counterexamples to the Kalman problem, *Doklady Mathematics* 82 (1) (2010) 540–542. doi:10.1134/S1064562410040101.
- [37] G. Leonov, N. Kuznetsov, Algorithms for searching for hidden oscillations in the Aizerman and Kalman problems, *Doklady Mathematics* 84 (1) (2011) 475–481. doi:10.1134/S1064562411040120.
- [38] V. Bragin, V. Vagaitsev, N. Kuznetsov, G. Leonov, Algorithms for finding hidden oscillations in nonlinear systems. The Aizerman and Kalman conjectures and Chua’s circuits, *Journal of Computer and Systems Sciences International* 50 (4) (2011) 511–543. doi:10.1134/S106423071104006X.
- [39] M. Kiseleva, N. Kuznetsov, G. Leonov, Hidden attractors in electromechanical systems with and without equilibria, *IFAC-PapersOnLine* 49 (14) (2016) 51–55. doi:10.1016/j.ifacol.2016.07.975.
- [40] M. Kiseleva, N. Kuznetsov, G. Leonov, P. Neittaanmaki, Hidden oscillations in drilling system actuated by induction motor, *IFAC Proceedings Volumes (IFAC-PapersOnline)* 5 (2013) 86–89. doi:10.3182/20130703-3-FR-4039.00028.
- [41] G. Leonov, N. Kuznetsov, M. Kiseleva, E. Solovyeva, A. Zaretskiy, Hidden oscillations in mathematical model of drilling system actuated by induction motor with a wound rotor, *Nonlinear Dynamics* 77 (1-2) (2014) 277–288. doi:10.1007/s11071-014-1292-6.
- [42] M. Kiseleva, N. Kondratyeva, N. Kuznetsov, G. Leonov, E. Solovyeva, Hidden periodic oscillations in drilling system driven by induction motor, *IFAC Proceedings Volumes* 47 (19) (2014) 5872–5877. doi:10.3182/20140824-6-ZA-1003.02449.
- [43] G. Leonov, N. Kuznetsov, Mathematical model of the Sayano-Shushenskaya hydroelectric power station: analytical-numerical analysis of stability and oscillations, in: 9th Scientific and Technical Conference “Hydropower: new developments and technologies”, 2015.
- [44] V. Fortov, M. Fedorov, The accident at the Sayano-Shushenskaya HPP and the scientific and technical support of its recovery, in: Meeting of the Presidium of the Russian Academy of Sciences, 2010(in Russian).

Declaration of Competing Interest

The authors declare that they have no conflict of interest.

Journal Pre-proof

Credit Author Statement

Conceptualization, Methodology: N. Kuznetsov Investigation, Writing-
Reviewing, Editing: N. Kuznetsov, M. Yuldashev, R. Yuldashev

Journal Pre-proof