

Teemu Alviola

Energy efficiency in wireless networks

Master's Thesis in Information Technology

September 13, 2013

University of Jyväskylä

Department of Mathematical Information Technology

Author: Teemu Alviola

Contact information: teemual@gmail.com

Supervisor: Tapani Ristaniemi

Title: Energy efficiency in wireless networks

Työn nimi: Langattomien verkkojen energiatehokkuus

Project: Master's Thesis

Study line: Mobile Systems

Page count: 162+4

Abstract: This Master's thesis is a literature review that discusses energy efficiency and power savings in different wireless networks. The overall focus in this paper is set dominantly in 3G and LTE-networks. The thesis begins by recognising different types of reasons in the mobile industry to practice energy savings, and the reasons why energy efficiency is being so widely researched these days. Breakdown of energy consumption in wireless networks, as well as various different ways to improve energy efficiency in these networks follow in the latter part of the paper. The thesis also includes a brief Octave-simulation concerning the energy efficiency of a collaborative mobile cloud. The thesis concludes with a summary of the current state of the various energy savings technologies in use.

Keywords: Energy, Efficiency, Energy-efficiency, Wireless, Networks, 3G, 4G, 5G, LTE, Wi-Fi, WDC, WMN, Green, TANGO, Beamforming, Mobile

Suomenkielinen tiivistelmä: Tämä pro gradu -työ on sekundääritutkimuksena tehty kirjallisuuskatsaus energiatehokkuuden tarkastelusta langattomissa verkoissa. Työssä tarkastellaan erilaisia mobiiliverkkojen energiansäästömahdollisuuksia. Pääpaino työssä on suunnattu erityisesti 3G ja LTE -verkkoihin, kuitenkin eksoottisempiakaan verkkoja unohtamatta. Työ alkaa erilaisten mobiiliverkkojen energiansäästösyiden ja tutkimusmotivaattoreiden tunnistamisella ja jatkuu langattomien verkkojen energian kulutuksen jaotuksella, sekä erilaisten energiansäästömahdollisuuksien vertailuilla. Työn empiirisessä osassa nostetaan lisäksi

esille lyhyt Octave-simulaatio kollaboroivan mobiilipilven noodien energiansäästöä. Työ päättyy yhteenvedolla erilaisista jo käytössä olevista energiansäästötavoista.

Avainsanat: Energia, Tehokkuus, Energiatehokkuus, Langaton, Verkko, 3G, 4G, 5G, LTE, Wi-Fi, WDC, WMN, Green, TANGO, Beamforming, Mobiili

Preface

I would like to thank my thesis supervisor, Dr. Tapani Ristaniemi for his advice and guidance. Acknowledgments also extend to Mr. Zheng Chang for meaningful discussions concerning the mobile cluster research simulation.

Jyväskylä, September 13, 2013

Teemu Alviola¹, BEng.

1. CQ CQ CQ DE OH6FYR OH6FYR K

Glossary

3G	3 rd Generation of mobile telecommunications technology
4G	4 th Generation of mobile phone communication standards
AP	Access Point
ATM	Asynchronous Transfer Mode
BER	Bit Error Rate
BS	Base Station
BSC	Base Station Controller
BTS	Base Transceiver Station
CDMA	Code Division Multiple Access
CDMA2000	A group of 3G mobile technology standards
DSP	Digital Signal Processor
DVB	Digital Video Broadcasting
DVS	Dynamic Voltage Scaling
E1	E-carrier (level 1), a digital transmission system used throughout Europe and most of the rest of the world.
FCC	Federal Communications Commission
GigE	Gigabit Ethernet
GPRS	General Packet Radio Service
GSM	Global System for Mobile communications, commonly known as <i>the 2nd Generation digital cellular network (2G)</i>
IEEE	Institute of Electrical and Electronics Engineers
IP	Internet Protocol
ITU	International Telecommunication Union
Li-Fi	Light Fidelity
LOS	Line-Of-Sight
LTE	Long-Term Evolution, alternative nomenclature 4G LTE
MAC	Media Access Control
MIMO	Multiple-Input, Multiple-Output
MSC	Mobile Switching Centre

MT	Mobile Terminal, (<i>e.g. the cell phone</i>)
MTX	Mobile Telephone eXchange
Node B	Node B is the UMTS equivalent to the BTS used in GSM.
OFDM	Orthogonal Frequency Division Multiplexing
PA	Power Amplifier
PAN	Personal Area Network
QoS	Quality Of Service
RAN	Radio Access Network
RAT	Radio Access Technology
RBS	Radio Base Station
RF	Radio Frequency
RRM	Radio Resource Management
RSSI	Received Signal Strength Indication
SGSN	Serving GPRS Support Node
SNR	Signal-to-Noise Ratio
T1	T-carrier (level 1), digital transmission system used primarily in the USA. Incompatible with E1.
TD-SCDMA	Time Division Synchronous Code Division Multiple Access
TDD	Time Division Duplex
TDMA	Time Division Multiple Access
Transceiver	An unit that contains both the transmitter and the receiver.
UMTS	Universal Mobile Telecommunications System
UTRA	UMTS Terrestrial Radio Access
W-CDMA	Wideband Code Division Multiple Access
WiMAX	Worldwide Interoperability for Microwave Access
WLAN	Alternative commercial nomenclature: " <i>Wi-Fi</i> " – a set of IEEE 802.11 standards defining a Wireless Local Area Network
WMAN	Wireless Metropolitan Area network
WPAN	Wireless Personal Area Network
WRAN	Wireless Regional Area Network

List of Figures

Figure 1. Illustration of the global ICT footprint	3
Figure 2. Illustration of the global telecoms footprint in 2002	4
Figure 3. Illustration of the global telecoms footprint in 2020	4
Figure 4. A typical PA response curve	24
Figure 5. Associations between green and wireless energy efficiency together	26
Figure 6. Mobile network cells	32
Figure 7. Mobile network cell groups	33
Figure 8. Cell types versus their intended uses	42
Figure 9. Illustration of different antenna radiation zones	43
Figure 10. 4-element antenna array	45
Figure 11. 9-element antenna in an uneven spiral array	46
Figure 12. 3 SDMA radiation cones	47
Figure 13. Illustration of a network of cells	67
Figure 14. Illustration of cell zooming for energy savings gains	68
Figure 15. Illustration of cell zooming for load balancing	69
Figure 16. Illustration of a simple MIMO-system	75
Figure 17. A simplistic example of wireless relaying	78
Figure 18. Overview of Wireless Mesh Network -topology	81
Figure 19. Advances in LTE-A compared to existing technologies	95
Figure 20. Illustration of round-robin communication	117
Figure 21. Illustration of DMC collaboration	118
Figure 22. Comparison of a non-collaborative transmit scenario vs. a DMC	120
Figure 23. Illustration of the energy efficiency gain from DMC-collaboration	124

List of Tables

Table 1. Main differences between horizontal and vertical handover	88
Table 2. Technological differences in horizontal and vertical handover	89
Table 3. Octave code listing comments	157

Contents

1	INTRODUCTION	1
1.1	Some background on energy efficiency	1
1.2	Energy usage in wireless systems	6
1.2.1	3G overview in brief	10
1.2.2	LTE overview in brief	11
2	ENERGY EFFICIENCY BACKGROUND AND MOTIVATORS	14
3	IMPLEMENTATIONS FOR ATTAINING HIGHER ENERGY EFFICIENCY	16
3.1	Possible energy savings techniques	18
3.2	Green communications	21
3.3	Traffic-Aware Network planning and Green Operation	27
3.4	Different wireless network cell types	29
3.4.1	Small cells	31
3.4.2	Femtocells	36
3.4.3	Picocells	38
3.4.4	Microcells	40
3.4.5	Metrocells	40
3.4.6	Macrocells	41
3.5	Beamforming	42
3.6	Cognitive radio networks	48
3.7	Wireless Distributed Computing	51
3.7.1	Wireless network distributed computing	54
3.7.2	Mobile agents	57
3.8	Base station sleep mode	59
3.9	Cell wilting, cell blossoming and cell zooming	65
3.10	Multiple antenna systems	72
3.11	Relays	76
3.12	Wireless mesh networks	79
3.13	Network co-operation between different available networks	85
4	FUTURE WIRELESS NETWORKS AND ENERGY EFFICIENCY	90
4.1	5G	90
4.2	Infrastructure improvements and new innovations	95
4.3	Visible light communication	105
5	MOBILE CLUSTER SIMULATION	117
6	SUMMARY	125
6.1	Conclusions	126
	BIBLIOGRAPHY	128
	APPENDICES	154

A	Octave code listing for the DMC simulation.....	154
B	Octave code listing comments	156

1 Introduction

This master's thesis is a literature review of the currently used energy efficiency methods in wireless networks, with a focus set dominantly in the 3G and LTE -networks and their derivatives. The thesis is loosely based on and motivated by an unpublished report on wireless efficiency I wrote as a research project at the University of Jyväskylä during the spring of 2012. I then chose to continue investigating this topic and to expand the report into a form of a master's thesis, because I found the subject rather interesting and because I felt the topic needed further update and research.

This thesis consists of 6 sections. Section 1 serves as an introduction to the various energy efficiency -related issues in mobile computing and mobile communications. It also discusses the reasons why energy efficiency is becoming more and more important these days, not only for the wireless service providers, but also for the end-users themselves. Section 2 discusses some of the background issues concerning energy efficiency, as well as some of the different motivators and reasons to research energy efficiency. Section 3 discusses different possible implementations of practicing energy savings found in literature, as well as the efficiencies of the presented methods. Section 4 reflects the energy efficiency for some of the upcoming wireless technologies. Section 5 presents a scheme called *distributed mobile cloud*, as well as some more analytical evaluations of the energy efficiency possibilities arising from deploying the introduced method. Summary of findings, as well as conclusions is presented in section 6.

1.1 Some background on energy efficiency

There are a number of reasons why different mobile network operators and mobile network device manufacturers are together globally researching different ways to optimise their network performance from the energy efficiency and capacity standpoint. The ever-increasing number of peripheral equipment running online has, and will continue to lead to increased demands for energy supplies. The pressure to optimise the energy efficiency is not entirely on the operator's shoulders, but also on the device manufacturers, who all have to be able to

design and manufacture more compelling solutions for the operators to implement and for the consumers to purchase.

A lot of money in the mobile networks is being wasted, particularly in the network's RBSs, in the form of energy consumption – partly because the RBSs are not being used in the most optimal and efficient way, and partly because more efficient and elegant solutions have been developed to handle some of the RBS's features better than the current RBS's themselves. Operating costs are also being jacked up because of the increase of the carbon footprint of the wireless networks. This increase is due to the fact that the mobile networks are growing more and more each day, together with the data volumes transferred by each customer. Network growth is mainly due to the fact that the traffic of the network rises as the user base expands each day. Users's faster data plans, USB-data dongles for laptops, smartphones, tablet computers, and the fact that the MT prices are going gradually down are the main reasons that further contribute to the congestion of the networks (Sutton and Cameron 2011).

Ratio of mobile voice traffic versus mobile data traffic gradually shifts more and more towards mobile data. Furthermore, the content that the users consume online is not just traditional email and static webpages anymore, but it's rapidly moving more towards the modern dynamic Web 2.0/Web 3.0 and online social video services, which account for a very big role in the used bandwidth. Growing CO₂ emissions also mean that the price of the energy will eventually go up, not only due to the CO₂ emission limitations (or more specifically, CO₂ emission credits trading), (Grubb 2003), but also simply because more greener and thus more expensive-to-use power plants are needed to meet the future clean power needs of the wireless networks and their users.

The Japanese telecommunication operator *NTT DoCoMo* has released data, that the ratio of the power consumption between the MT and the mobile network is nearly 1:150 – more specifically, meaning that the MT consumes a mere 0.83 Wh/day (incl. battery chargers and terminals), whereas the network uses 120 Wh/day (Etoh, Ohya, and Nakayama 2008). In TDMA networks, the RF uplink constitutes 60% of the total energy usage of the MT's radio (Kim, Yang, and Venkatachalam 2011). Within the energy usage of a mobile device, the manufacturing of the device itself costs the most when it comes to the CO₂ emissions – well over two-thirds (Auer et al. 2010).

Figure 1 on page 3 illustrates the global ICT footprint in gigatonnes of CO₂e¹ in the year 2002, 2007, as well as a CAGR² estimate for 2020 (Group 2008). ICT in this context represents the PCs, telecommunications networks and -devices, printers and data centres. The year 2007 figure represents roughly a mere 2% of the estimated human global annual total emissions. Embodied carbon refers to the amount of carbon in CO₂, that was once used for resource extraction, transportation, manufacturing and fabrication of the devices or products themselves.

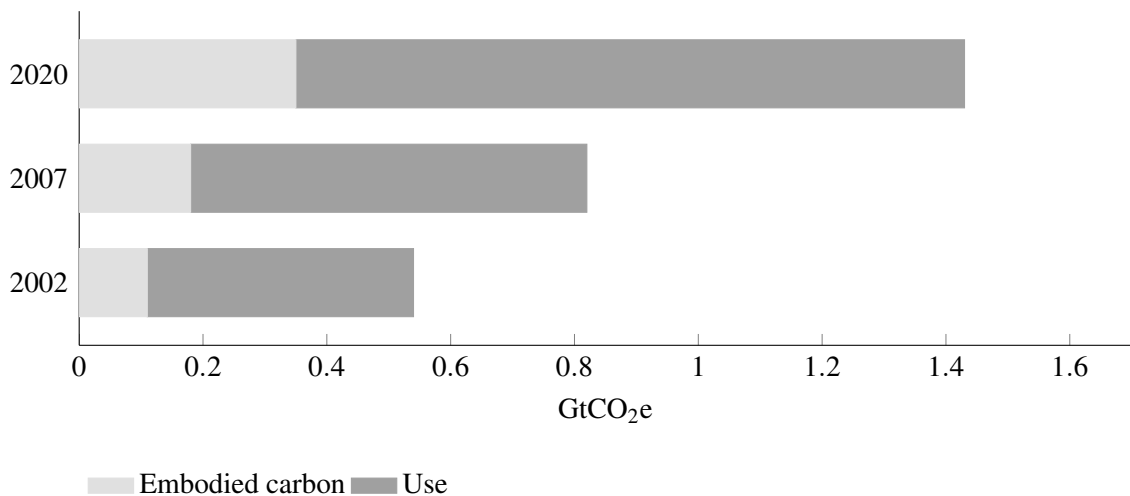

Figure 1. Illustration of the global ICT footprint (in GtCO₂e).

Figures 2 and 3 on page 4 represent the global telecoms footprint (in megatonnes of CO₂e)³ in 2002 and 2020 for devices and infrastructure (Group 2008). The relative amount of mobile traffic, as well as fixed broadband traffic increases quite noticeably, whereas for the fixed narrowband, the traffic is going to shrink.

The European Union (within the framework program FP7) started and funded a project in 2010 along with 15 partners from the industry, academia and business called *Energy Aware Radio and neTwork technologies* (EARTH). The purpose of EARTH was to search for effective solutions and results for the improvement of wireless energy efficiency in communication networks, especially LTE and LTE-A in particular (but it will also consider 3G

1. Equivalent carbon dioxide.
 2. Compound Annual Growth Rate.
 3. One unit of carbon is equivalent to 3.664 units of CO₂.

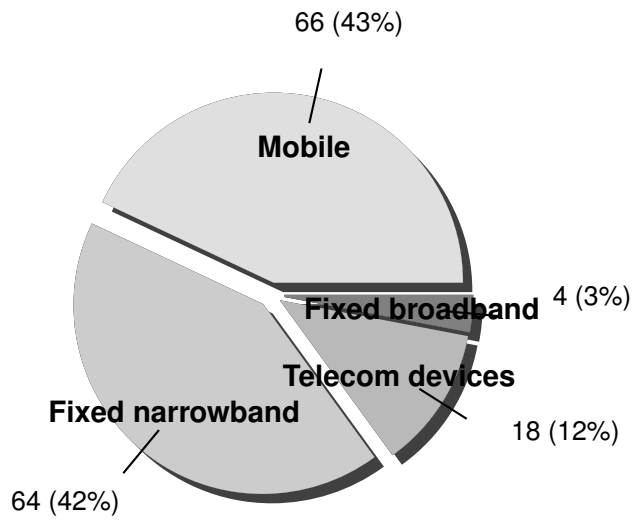

Figure 2. Illustration of the global telecoms footprint (in MtCO₂e) in 2002 (100% = 152 MtCO₂e).

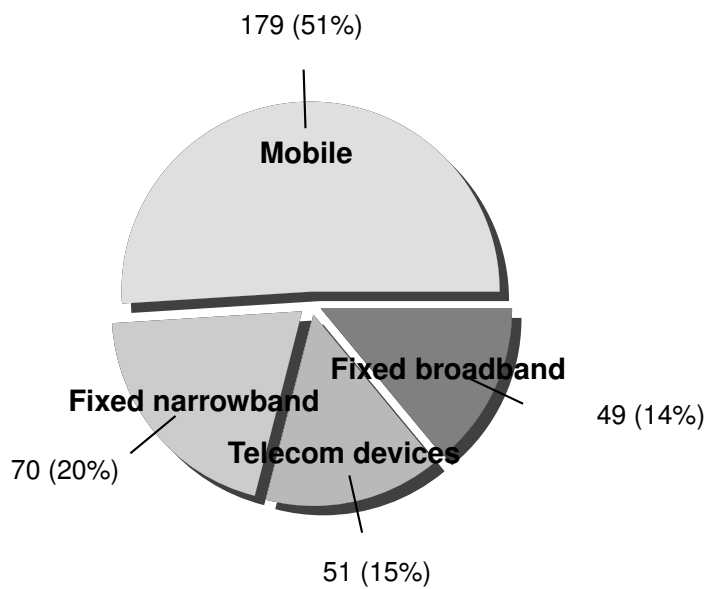

Figure 3. Illustration of the global telecoms footprint (in MtCO₂e) in 2020 (100% = 349 MtCO₂e).

(UMTS/HSPA) technology for immediate impact), and the ICT in general. The target was set especially for low load situations (Gruber et al. 2009). A goal was set for EARTH to cut the energy consumption of wireless broadband networks by 50%.

International Data Corporation (IDC) expects smart connected device shipments to grow by 14% annually through 2016, led by tablets and smartphones. The worldwide total unit shipments for smart connected devices is expected to reach nearly 1.2 billion in 2012, and grow to 1.4 billion in 2013, and that the combined worldwide smart connected devices market will surpass 2 billion units in 2016 (USA 2012).

There are several other research projects that cover the open issue of energy efficiency in wireless systems, as well as in their components too:

- OPERA-Net

OPERA-Net (*Optimising Power Efficiency in mobile RAdio Networks*) (Celtic-Plus 2013), which investigated the different ways to improve the energy efficiency of broadband cellular networks by focusing on the optimised cooling and energy recovery from the BSs, and the optimisation of the components used in communication systems.

- PANAMA

PANAMA (*Power Amplifiers aNd Antennas for Mobile Applications*) -programme (CATRENE-Programme 2013) focuses on different ways to save energy by more efficient design of the PAs, due to the fact that the PAs are the BS's major energy consumers, that typically still run at a fairly low efficiency.

- Cool Silicon

Cool Silicon (Silicon 2013) -project focuses on making recommendations for high performance communication systems with low energy consumption, by focusing on three main areas: micro/nano technology, broadband wireless access, and wireless sensor networks. The project focuses also on the optimisation of the individual aspects of the communication systems like the architecture of the system, communication algorithms and protocols, as well as physical components.

The technologies implemented to enhance the energy efficiency of one end of the communication system (either in the transmitter or receiver) may adversely affect the energy efficiency of the other end. For example, increasing the frequency reuse in a multiuser system, and adopting efficient multiuser scheduling techniques may lower the transmit energy requirement for the same spectral efficiency, but on the other hand the receiver needs more computation (and thus more computational energy) for performing the multiuser detection (Gruber et al. 2009).

A lot of energy is also being wasted into the cooling of the RBS's, as the RBS's normally operate at full power even when they are not being used at all, or when the usage is quite minimal (*e.g. during the night or in the rural area*). Reducing the time the RBS's operate at full power also reduces the need to cool them down. It is not only the networks themselves that will have to be reassessed to help improve the energy efficiency, but also the electronics manufacturers' solutions and the signal processing techniques have got to improve. The only way to meet the ever heightening power needs of the users's mobile computing, is when the electronics manufacturers, signal processing improvements and RBS redesigns work together – none of these alone will suffice. Fundamental architectural redesigns are essential.

The energy optimisation, and thus lessened power requirements also paves way to the possible scenario, where parts of the network are being powered by the limited, renewable energy sources (*e.g. solar panels or windmills*). This also makes the usage of picocells more reasonable and realistic. More on picocells at section 3.4.3 on page 38. Increasing the energy efficiency is the only way to maintain sustainable growth of the mobile industry.

1.2 Energy usage in wireless systems

About 70-80% of a typical mobile network's power consumption accounts either for the BS, or the radio sites (EARTH-Project 2010), (Huawei Technologies Co. 2013). According to a paper by (T. Chen et al. 2011), the energy consumption of a typical mobile phone operator's RBS site composes mainly of the power usage of the RBS itself, MTX, and the core network. Data centre and retail energy consumptions, which are both in a more of a supportive role in

the big picture, play quite an insignificant role.

From the energy consumption standpoint, the BS itself comprises of the RBS, power supply (DC-DC and AC-DC), RF-transceiver, climate control, battery back-up, as well as an optional transmission link in the baseband unit in the bigger BSs to connect to the operator's network for platform control and medium access control. The RBS itself consists of the PA and multiple transceiver units. At full load the BS's radio units dominate the site's power consumption, which is completely reasonable (and to be expected), but at *near zero* load they still remain significant. To be more exact, the power consumption at 1% traffic load is in the order of 50% of the maximum (Ferling et al. 2010).

Power losses exist also in the power and signal transmission lines, as well as in the feeder lines, which also contribute to the overall power consumption. For smaller BSs, these feeder losses become less significant due to the smaller transmitted power levels. The climate control unit that keeps the main heat dissipator, the PA, cool plays a large role in the overall energy consumption as well.

This is also the reason why the usage of the PA must be placed under a tight scrutiny in order to keep the need of its cooling equipment at a minimum as well. The semiconductor- and the silicon technology also play a large role in the BS's overall power usage. The higher the power efficiency gets, the more leakage also occurs. The International Technology Roadmap for Semiconductors believes that doubling the power efficiency multiplies the leakages by threefold, thus also vitiating the possible power reduction away (Auer et al. 2011), (Borkar 1999).

Losses occur also at the antenna interface due to the impedance matching losses, bandpass filters and duplexers. For low power nodes, picocells, etc, the PA constitutes of fewer than 30% of the total power usage, whereas for larger macrocells, the PA accounts up to 55-60% of the BS's total power usage. Implementing a scenario where the PA is mounted at the same physical location as the macrocell BS site's transmit antenna, technique also known as *remote radio head*, enables the feeder losses and active cooling to be reduced greatly.

Impedance mismatches are reflections from the transceiver's amplifier into the antenna, and

back again into the transceiver's amplifier. The phenomenon is more commonly known⁴ as *standing wave ratio* (SWR). SWR is essentially the ratio of the partial standing wave amplitude at the maximum, compared to the amplitude at the minimum. These reflections depend on the impedance (mis)matching between the amplifier (and feeder), and the antenna, which in turn depends on the power level, frequency and the antenna environment. SWR ratio is always the same as the ratio of the impedances of the feeder and the antenna elements. Active tuning of the matching network can aid with these reflections. SWR is defined mathematically in (1.1) with the help of (1.2) (Dana George Reed 2002):

$$SWR = \frac{1 + |\rho|}{1 - |\rho|} \quad (1.1)$$

From which the complex reflection coefficient (ρ) can be determined with:

$$\rho = \frac{(Z_a - Z'_0)}{(Z_a + Z_0)} = \frac{(R_a \pm jX_a) - (R_0 \mp jX_0)}{(R_a \pm jX_a) + (R_0 \pm jX_0)} \quad (1.2)$$

where:

Z_a is the characteristic load impedance

Z_0 is the characteristic impedance of the transmission line

Z'_0 is the complex conjugate of Z_0

R_a is the load resistance

R_0 is the line's characteristic resistance

X_a is the load reactance

X_0 is the line reactance

Usually the characteristic impedance Z_0 is for most transmission lines practically entirely resistive, in which case the above formula (1.2) can be modified to be $Z_0 = R_0$, and $X_0 \cong 0$, and expressed as in formula (1.3):

$$|\rho| = \sqrt{\frac{(R_a - R_0)^2 + X_a^2}{(R_a + R_0)^2 + X_a^2}} \quad (1.3)$$

4. Just ask any ham radio operator.

To obtain and calculate the ρ more commonly (and *easily*) using a RF-wattmeter is expressed in (1.4). An even easier trick however would be to just use an SWR-meter or an antenna or vector network analyser.

$$\rho = \sqrt{\frac{\text{Reflected wave power}}{\text{Forward wave power}}} \quad (1.4)$$

Mobile networks normally require a large number (in the order of thousands) of BSs to provide nationwide coverage. Each BS can require – depending on its configuration, load of the cell, and age of the equipment, up to 2.7 kW of power (Rinaldi and Veca 2007). The energy consumption for a nationwide coverage can thus be in the order of several MW. Mobile networks are therefore systems where the effects of energy efficiency can be considerable.

A lot of energy has also obviously once been used to manufacture the wireless equipment themselves, but for entities such as the BS site, this manufacturing cost is negligible, due to the comparably long life span of the system itself, during which the system uses a fair bit more energy than once went into the manufacturing of the equipment itself. For BS sites, the equipment's operating power is in a much more important role than for the end-user terminals, due to the fact that the end-user devices (MTs) typically don't last as long and have to be replaced much more frequently anyway. In addition, the end-user devices use much less power to operate than the BSs do.

The non-working time (*i.e. the time during the holidays and nighttime*) is in fact more than 50% of the year. The needlessly spent energy of the existing wireless networks is thus astounding. Typical Internet service providers experience long time network utilisation average of about 20% – which is to say that a lot of resources are being wasted just in order to provide a constant preparedness for the potential high load situation. A 0,5% call dropping probability requires 30% of system's capacity to be constantly reserved (Kim and Veciana 2010), (Oliveira, Kim, and Suda 1998). This misuse grows into an even more severe problem for the future wireless networks, where the size of the cells is going to get even smaller and smaller (*e.g. micro- or pico-cellular*), to be able to serve even more high-data-rate users and to increase the frequency reuse factor – which will in effect further increase the dynamics of the traffic in a cell.

This brings up an important notion of how to get the network's transmitters to adapt to the traffic fluctuation, and to completely switch off the BSs if the load in the network drops below a specific threshold – furthermore, how to guarantee satisfactory service to the users in the case the transmitter's power is indeed reduced, or the BS is turned off completely? The distribution of the radio resources over heterogeneous⁵ cellular networks should be optimised in a global way, hence the colloquial term (*Globally Resource-optimised and Energy-Efficient Networks (GREEN)*). More on GREEN at section 3.2 on page 21.

In essence, there are two types of wireless traffic load fluctuations in a cellular network that can be distinguished. First one is the large-scale fluctuation, in which the traffic load varies notably from one time period to another throughout the day – this can be thought to represent the workforce commuting from one region of the city to another. The second type is the small-scale fluctuation, in which the wireless traffic load varies only slightly around some average value – this can be thought to represent the random city life with people going about their business throughout the day and the MT sporadically experiencing impaired service quality.

1.2.1 3G overview in brief

Different views exist throughout the wireless industry as to what exactly does the term 3G contain. First generation (1G) cellular services were implemented by using analogue RATs only. As the analogue networks were upgraded to digital ones in the late 90's, it was rather straightforward to call it the second generation (2G) network. The naming transition from 2G to 3G wasn't however so obvious. Throughout the years, the ageing 2G networks were upgraded extensively to incorporate better capabilities into them with higher performance, thus narrowing the gap to what later on became known as 3G or *UMTS*. The naming issue hasn't really changed all that much with the introduction of 4G, which in a sense is nothing more but an evolution of the 3G technologies – however, it can be safe to say that 3G can be thought to be the third generation of mobile service capabilities.

In order to distinguish 3G from 2G, the ITU⁶ defined substantially higher performance lev-

5. Superposed small and large cells in a wireless network.

6. A United Nations specialised agency responsible for information and communication technology matters.

els for 3G compared to those obtained from 2G mobile networks (ITU 2013). Comparing to its predecessor, 3G supports higher capacity, enhanced network functionalities, as well as the capability to multimedia applications (IMT2000-Project 2002). There are also applications for 3G in wireless voice telephony, mobile Internet access, mobile video calls and mobile TV. Various radio interfaces for UMTS are available (*e.g. W-CDMA, TD-SCDMA and CDMA2000*).

No clear definitions of the available minimum or average data rates in a 3G network, or for the 3G equipment have been defined by the ITU. Performance specifications were once limited to an open ended comment (covering indeed for a wide variety of data rate possibilities), stating that: "It is expected that IMT-2000 will provide higher transmission rates: a minimum speed of 2 Mbit/s for stationary or walking users, and 348 kbit/s in a moving vehicle" (ITU 2011). The vagueness itself leaves plenty of headroom for the operators to more freely choose the advertised data rates and thus sell the products easier with the "3G"-label attached to them.

1.2.2 LTE overview in brief

LTE, whose RAT is called *Evolved UMTS Terrestrial Radio Access Network* (E-UTRAN), was set aggressive performance requirements relying on physical layer technologies, such as, OFDM, MIMO and Smart Antennas to achieve these targets in a variety of coverage scenarios. The main objectives of LTE were set to minimise the system and user equipment complexities, allow flexible spectrum deployment in either existing or new frequency spectrum and to enable co-existence with other 3GPP⁷ RATs (Motorola 2008) at least for the next 10 years and beyond – hence the term "Long-Term Evolution of the 3GPP radio-access technology" (3GPP 2013b, 3GPP TR 25.913 V9.0.0 (2009-12)). Smart antennas are discussed in more detail along with beamforming antennas at section 3.5.

Core qualities of LTE (3GPP 2013b):

- Objectives

7. The 3rd Generation Partnership Project, which with its member organisations, produces reports and standards.

The objective of Evolved UTRA and UTRAN is to develop a framework for the evolution of the 3GPP RAT towards a high-data-rate, low-latency and packet-optimised RAT.

- Data rates

E-UTRA should support significantly enhanced instantaneous peak data rates over legacy technologies, which should in turn scale according to the size of the allocated spectrum.

- Latency

LTE should significantly reduce the system latencies.

- User throughput

Several fold difference in user throughput (per MHz) over previous technologies.

- Spectrum efficiency

Significantly improved spectrum efficiency and increased cell edge bit rate using already existing site locations.

- Mobility

Mobility should be optimised for low mobile speeds between 0 ~ 15 km/h, while speeds up to 500 km/h should be nevertheless supported.

- Coverage

E-UTRA should be sufficiently flexible to support a variety of coverage scenarios using the existing UTRAN sites with the same carrier frequency.

- Further Enhanced MBMS

E-UTRA systems should support enhanced *multicast broadcast multimedia services* (MBMS) -modes, compared to UTRA (3G) operation.

- Spectrum

Support for diverse and different sized spectrum allocations, as well as requirements to co-exist with other networks and operators on adjacent channels, or to exist standalone.

- Co-existence and interworking with 3GPP RAT.

2 Energy Efficiency background and motivators

Power consumption has a direct impact on energy consumption. Power reductions, as well as energy efficiency are critical factors when operating using green energy sources (such as solar or wind power), which are power and not energy constrained. The MT's active mode power consumption is not the only property critical from energy efficiency standpoint – throughput (*e.g. Joules/Mbit*) also plays an important role. Consider the situation where the device has a high active mode power consumption – it might still be comparably energy efficient to use the device if it had a very fast data connection, and thus a low time period of highly consuming active mode (Shor 2008).

Mobile data is growing at such a high rate that the conventional macrocell networks cannot meet the demand set by the ever growing number of clients, either economically, or functionally. It is impossible to set up macrocells absolutely everywhere, where the capacity is needed due to the regulatory, spatial, or financial constraints. The only reasonable solution to serving a high number of MTs with a relatively low cost is to break the large macrocells down into much smaller areas, and to assess the cooperation possibilities of the macrocell BSs with much smaller and lower powered cells in it – such as placing a pico- or femtocell BS into an office, or for example a metrocell (or a few) into a large football arena. The cells smaller than macrocells have a colloquial term *small cells*. More on different cells at section 3.4.1 on page 31.

Deploying a network with only small cells would imply using a large number of BSs. However, a large number of BSs also increases the handoff rates of the MTs among the adjacent cells, and may also therefore degrade the gross energy efficiency of the whole network. A joint deployment of BSs with differing cell sizes is suitable, and above all necessary in order to upkeep the balance of different cell sizes for the highest energy efficiency network layout. Moreover, the overusing of the small cells increases the number of BS operating at low loads, which may cause the overall energy efficiency to degrade. This is also why for each deployment scenario (*e.g. urban vs. rural*), heterogeneous deployment with an optimal balance of macro-, micro-, pico-, and femto -cells must be found for the highest energy efficiency network layout.

The deployment of cellular networks is usually optimised for omnipresent radio access for the MTs. This however requires that a significant portion of BSs is primarily only providing coverage, and therefore not operating at full load – even at peak traffic hours. During off-peak hours, almost all BSs operate obviously at low load, or they might not even serve any MTs at all (Correia et al. 2010).

Regrettably, the energy efficiency of BSs is exceptionally poor in these circumstances. The inefficiencies can be further broken down into (Correia et al. 2010):

- Component level

The efficiency of the PA substantially degrades at a lower power output level.

- Link level

System information, synchronisation, and reference signals (or pilots) are to be transmitted continuously. This requires that BSs are incessantly on.

- Network level

The wireless network deployment paradigm with large macrocells in it needs small cells to supplement and fulfil the peak capacity demand. This is however rather static topology and doesn't therefore adapt very well to low load situations.

In order to meet these inefficiencies, a holistic strategy for network operation must be developed.

Easily one of the most popular metrics for measuring the energy efficiency of a communications link is the consumed energy for the number of information bits, or *Joules/bit*. In wireless networks, this formula gives the total energy consumed by the whole network per the aggregate network capacity. Whereas this energy efficiency -metric relates to processed information and its cost at full load, at lower loads the formula W/m^2 fits better for the demand to minimise the power consumption to cover a certain area.

3 Implementations for attaining higher energy efficiency

This section discusses several different possible implementations for achieving energy savings in wireless communications, as well as the following paramount topics regarding the wireless energy efficiency improvements:

- Green-communication

Globally Resource-optimised and Energy-Efficient Networks – Green is a marketing term for the improvement of energy efficiency and energy independence of telecommunications without any notable impact on the QoS. Green is discussed in more detail at section 3.2 on page 21.

- Traffic-Aware Network planning and Green Operation (TANGO)

TANGO aims at the optimisation of the radio resources as well as the energy efficiency within, without impeding the coverage using the Green -framework. TANGO is discussed in more detail at section 3.3 on page 27.

- Different wireless network cell types

Evaluations of the different wireless network cell types, as well as the following small cell technologies beginning from section 3.4 on page 29:

- Small cells, at section 3.4.1 on page 31.
- Femtocells, at section 3.4.2 on page 36.
- Picocells, at section 3.4.3 on page 38.
- Microcells, at section 3.4.4 on page 40.
- Metrocells, at section 3.4.5 on page 40.
- Macrocells, at section 3.4.6 on page 41.

- Beamforming

The electronic steering of the antenna array with the purpose of creating higher directionality and thus sensibility to a specific sector while minimising the directionality to

another, unwanted sector. More on beamforming at section 3.5 on page 42.

- Wireless Distributed Computing (WDC)

The sharing of a computational problem on a wireless network of heterogeneous and independent radio nodes. WDC is discussed in more detail at section 3.7 on page 51:

- The concept of Wireless Network Distributed Computing (WNDC), is discussed in more detail at section 3.7.1 on page 54.
- Relationship of Mobile agents to WDC and on wireless energy efficiency in general is discussed at section 3.7.2 on page 57.

- Base station sleep mode

BS sleep mode refers to switching the BS's radio transmissions off whenever possible. More on BS sleep mode at section 3.8 on page 59.

- Cell wilting, cell blossoming and cell zooming

The BS's sleep- and wake-up transients are called cell wilting and cell blossoming. Cell zooming is a technique at the network layer that changes the cell size by adjusting the transmit power of the control signals (Niu 2011). More on this at section 3.9 on page 65.

- Multiple antenna systems

Commonly referred to as MIMO-systems. The multiple antennas can be used to increase the data rates through multiplexing, or to improve performance through diversity (Goldsmith 2005). Multiple antenna systems are covered in more detail at section 3.10 on page 72.

- Relays

Relay is a stand-alone device placed within the range of a wireless router, or an AP or a BS. It serves as a two-way relay for wireless signals between the AP and the remote clients unable otherwise to connect to the AP by themselves. Relays (which

are sometimes called *range expanders* or *repeaters*) are discussed in more detail at section 3.11 on page 76.

- Wireless Mesh Networks (WMN)

WMNs are rapidly deployable, robust and low cost. The end-to-end communication in WMNs can hop through multiple WMN nodes. More details of WMNs at section 3.12 on page 79.

- Network co-operation between different available networks

More details of networks of composite radio environments than can consist of multiple different RANs, such as Wi-Fi, 3G, DVB or PAN (Liu and Li 2006) at section 3.13 on page 85.

3.1 Possible energy savings techniques

Power control can be a useful tool in ensuring energy efficient spatial reuse, while minimising the energy consumption. These functionalities are quite similar to those of cell zooming. Cell zooming is nevertheless quite different from power control in many ways. Whereas power control focuses on the link-level performance as well as transmit power consumption, cell zooming focuses on the performance and energy consumption reduction of the network as a whole. Power control does not actively change the cell size, whereas cell zooming does, by adjusting the transmit power of control signals (Niu et al. 2010). More on cell zooming at section 3.9 on page 65. Various power control topics (fixed and variable signal-to-interference-ratio, beamforming and scheduling algorithms) from the perspective of energy efficiency were analysed in (Chiang et al. 2008).

The energy efficiency at the wireless network infrastructure level can be divided into three levels (Ismail and Zhuang 2011):

- Exploiting the renewable energy sources

Strictly from the environmental point of view, the goal of green radio communications

is to lower the CO₂ emissions. This can be achieved for instance by using renewable energy sources (*e.g. solar or wind power*) to supplement the energy received from the national power grid. Typically, the power generated to the national power grid is not produced from 100% renewable sources. Also, in the cold climates, the cold air can be used to aid the cooling of the BS equipment.

- Heterogeneous network cell sizes

By adopting different sized cells in the wireless network, the network can adapt to the mobility and to the increase of the users more efficiently and flexibly. Recent wireless technologies, such as femtocells, have met this demand with the capability to extend the cell coverage more easily into densely built and congested city buildings. Femtocells operate with much less transmission power compared to a macrocell, which is also why their BSs consume less energy. More on femtocells at section 3.4.2 on page 36 and macrocells at section 3.4.6 on page 41.

- Dynamic network planning

To take advantage of the spatial and temporal traffic load fluctuations by switching off some of the existing wireless resources when the traffic load is light, is known as *dynamic network planning*. Shutting down some of the resources can lead to increase in the transmission power of the active BSs in order to increase their cell radius to provide radio coverage for the shut down cells. This can also result in coverage holes if the maximum allowed transmission power of the remaining active BSs still cannot create necessary radio coverage for the shut down cells. This also leaves the network vulnerable to service disruptions as well as to intercell interference in these areas.

The modulation schemes used in WCDMA/HSPA and LTE characteristically have highly volatile signal envelopes, where the PAPR¹ (which is also known as the *crest factor*) can exceed over 10 dB. To boost the energy efficiency, signal conditioning algorithms, such as *crest factor reduction* (CFR) for decreasing the PAPR and *digital pre-distortion* to increase the PA's linearity, must be utilised to enable the PA's operation closer to saturation point

1. Peak-to-Average Power Ratio.

(Correia et al. 2010).

Non-Orthogonal CDMA has been used in 2G and 3G systems like WCDMA, CDMA2000, and CDMA, and it is the dominant multiple access technique for present 3G wireless networks. Compared with OFDMA², CDMA excels in cancelling the intercell interference, it is also resilient to channel fading, but not scalable for high data rate transmission in asynchronous transmission environments, and also its bandwidth is much larger than the data rate used to suppress the interference (Wang and Rangapillai 2012). In orthogonal modulations, the signals from different MTs are orthogonal to each other, and their cross correlation is zero. OFDMA is good especially for high data rates, but not efficient for inter-cell interference and low transmission power scenarios (Wang, Xiao, and Ping 2006a) and again (Wang, Xiao, and Ping 2006b).

In order to improve the energy efficiency, the BS's front end's consumed power should be able to scale as much as possible to meet the amount of served traffic. To achieve this, for instance load adaptive CFR along with adaptive power supply (for variable input power) in the PA should be utilised. High energy efficiency power management is required for reconfigurable circuits as their key elements.

A low power front-end for different levels of transmit power with adjustable performance has been proposed in (Debaillie et al. 2006). In the article a solution where the driver and the PA were both digitally controlled and thus flexible in terms of their output power, linearity, and DC power consumption, was presented. This type of flexibility is appealing, and thus desirable to be extended to cover the high power transceivers found in macrocell BSs as well. Techniques like DVS and frequency scaling are both able to adapt to the voltage and clock frequency of the platform, depending on the momentary load. This allows for scaling of the power consumed in the digital chain along with traffic.

The signal processing also accounts for a significant portion of the overall wireless network power consumption. Typically the extremely efficient transmission techniques also have a tendency to demand more intricate computations with a corresponding increase of processing

2. Orthogonal Frequency-Division Multiple Access. In OFDMA each individual user is assigned a subset of subcarriers.

power. The gains from advanced transmission techniques on the energy efficiency might thus get outweighed by the negative side-effects in other parts of the system – especially in small cells, where the wireless transmission power accounts for only a few percent of that of a macrocell. This is also why the baseband signal processing might end up dominating the overall energy consumption.

3.2 Green communications

Green energy, also known as *clean* or *sustainable* energy, is energy produced typically from renewable energy sources, such as solar, wind, tidal, or geothermal, that cause only a minimal impact on the environment and only minimal pollution. The term *green communications* is a loosely defined marketing term in the telecommunications community. It can typically be thought to represent either the *greenness* of the telecommunication's CO₂ -footprint, the act of attempting to lower the cost of the energy, or the attempt to lower the amount of consumed energy altogether without any perceivable impact on the QoS (He et al. 2011) – or it might even be used as an acronym for *Globally Resource-optimised and Energy-Efficient Networks* (Niu 2011). Green communications in practice could be generalised as different wireless networks, whose coverage areas overlap each other, that can (*and should*) cooperate together in order to reduce their combined energy consumption by alternately switching their resources on and off, according to the availing network load conditions and demand.

The energy efficiency focus in green radios evolves from minimising the energy consumption of the APs towards being able to produce the APs more economically with lower maintenance costs. This shift is due to the change in the energy source – from non-renewable (often plentiful and cheap) to renewable (but albeit sometimes scarce) forms of power. Using renewable and sustainable energy sources (with the appropriate battery backups) can eliminate the issue of gathering and paying for the energy. The green energy technologies are normally still more expensive to build than traditional ones, and so the centre of attention moves from OPEX towards the CAPEX of the green BS systems, as noted in (Cai et al. 2011). The authors of the article also studied the wireless network resource deployment and management, and ran simulations on different mechanisms to relay the network traffic through. The article also demonstrated the importance of choosing the appropriate call admission control scheme

for the network to preserve a desired QoS and performance.

One goal for attaining "green" can be to have an overall improvement in energy efficiency with a reduction of the greenhouse gases, but on the other hand, the combined impact of these properties together can be hard to measure. One popular metric to assess the wireless energy efficiency was published by The Green Grid association of IT professionals (Belady et al. 2008) and (Haas et al. 2009). A metric called *Power Usage Effectiveness* (PUE), as shown in formula 3.1, was developed to measure the data centre's total power consumption versus the power used by the servers, storage systems and network equipment altogether:

$$PUE = \frac{\text{Total Facility Power}}{\text{IT Equipment Power}} \quad (3.1)$$

A PUE ratio of 1 refers to the situation, in which all of the power is being used in the IT Equipment (*i.e. no air-conditioning or communication subsystems are required*). This is often a rather unrealistic scenario. An alternative method was presented in formula 3.2, especially suited for telecommunications systems to estimate the energy efficiency of the system, would be to divide the energy consumption of the communications system with the performance of the computational system:

$$\text{Computational energy efficiency} = \frac{\text{Communications system energy}}{\text{Computational system performance}} \quad (3.2)$$

The numbers for the above formula can however be hard to come by, as it can be difficult to quantify the effectiveness of the communications system, or even to decide which metric to use in the first place. BER³ is a common measure of the link quality, whereas spectral efficiency (*typically in bit/s/Hz*) defines the information rate that is possible to be transmitted using a given bandwidth. More reasonable and commercial point of view would be to divide the total consumed power with the total number of calls – or users, as shown in formula 3.3:

$$PUE = \frac{\text{Total power}}{\text{Total number of calls}} \quad (3.3)$$

3. A unitless performance measure ratio of received corrupted bits in a data stream divided by the total number of bits transferred.

Green radios are expected to operate from eco-friendly constrained power sources, such as solar or wind power. The need to improve the energy efficiency at the protocol stack, as well as in the system architecture, operational management and physical layer elements is a constant challenge for researchers. In general, the BS typically consists of only three major components: the baseband unit, the radio unit, and the feeder network. Of these elements, the radio consumes about 80% of the BS's power needs, and of that 80%, 50% is used in the PA (Huawei Technologies Co. 2013), making it a prime element that ought to be examined in order to enhance the energy efficiency in a BS. Also in a similar fashion in the MTs, it is the wireless modem that accounts for the vast majority of the power consumed, even for high CPU intensive tasks (Grauballe et al. 2007). It is because of these mentioned high percentages, that improvement of the energy efficiency in the PA is one of the key domains that needs to be considered in order to enhance the energy efficiency in the BS equipment.

The PA's conversion from DC power to RF AC power in order to improve the input signal is lossy, and one of the key properties that directly affect this efficiency is the input signal itself. One of the fundamental input signal's characteristic properties is the modulation scheme. Non-constant magnitude modulation schemes (*e.g. OFDM, due to its high peak to average power -ratio (PAPR)*), have a strict linearity requirement, which usually requires a large back-off from the PA's saturation point. A large back-off, *or reserve*, is required, but the back-off also poses challenges for the PA, as its efficiency is at its peak at the peak envelope power, and the efficiency tends to drop as its output power decreases.

A low PAPR enables the transmitter's PA to operate efficiently, whereas a high PAPR causes the PA to operate with a large back-off and with a low efficiency. Utilising high efficiency nonlinear switch-mode PA in various PA structures, or even DVS or envelope tracking, improves the PA's efficiency, and linearity. The figure 4 on page 24 approximates a typical PA response curve, in which the PA's linearity curve begins to distort as the input power increases. Having the PA operate in its linear response region typically helps to avoid distortion of the signal, which is also why the peak value is restrained to exist in this region.

Techniques exist for PAPR reduction, such as clipping, windowing, interleaving, elective mapping, and polar transmission – all of which can help increase the PA's efficiency for OFDM signals (Han and Lee 2005). Furthermore, multi-carrier BS technology, such as GSM

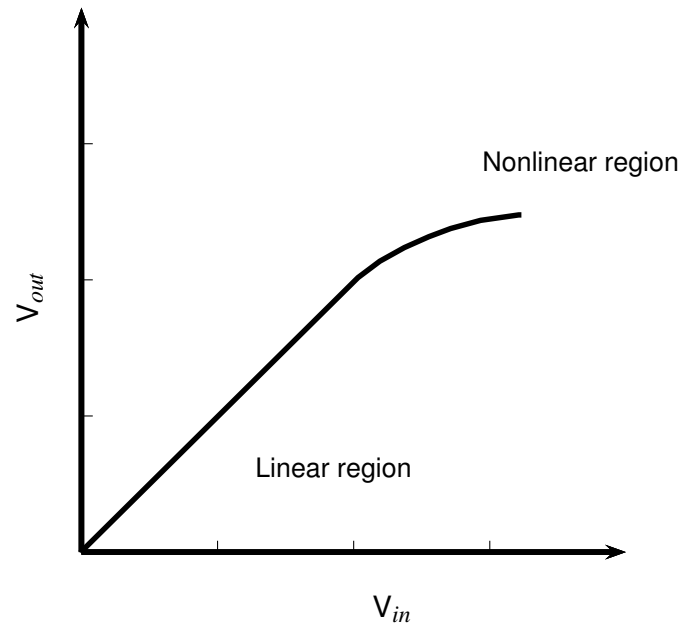

Figure 4. A typical PA response curve.

Quadruple Transceiver Technology, can reduce the maximum power consumption of the PA. Topology focused network designs, as well as improved network planning methodologies improve the energy efficiency by reducing the number of required sites. The smaller and more agile BS is an ideal fit for a distributed BS architecture, to replace the larger and more power-hungry macrocell BSs. In addition, game theoretic principles towards lowering the OPEX have been used for analysing the energy efficiency in CDMA networks (Betz and Poor 2008).

One key element for better energy efficiency in wireless communications is also the aim to reduce the distance between the MTs and the BSs. According to an article (Claussen, HO, and Pivit 2008), the joint deployment of macrocell BSs with publicly accessible residential picocells can help reducing the energy consumption by up to 60%. Despite the fact that femtocells are paving a pathway to high capacity with low power, there still remain some unresolved research issues concerning the distributed frequency management (López-Pérez et al. 2008), (Ho and Claussen 2007), on the interference avoidance between a femtocell and a macrocell (Chandrasekhar and Andrews 2007) and handover, self-optimisation and pilot

signal leakage (Claussen, Ho, and Samuel 2008). Whereas the traditional radio design is designed to be used with a constantly available power supply, the green radios can successfully maintain their QoS with a randomly varying power supply.

When focusing on the energy efficiency of the BSs, the issue can be split into two different categories: the network topology and the network elements -savings levels. The method of network topology-level energy-saving, means attempting to better the energy efficiency by reducing the number of BS sites. This leaves two options for implementation.

- Either increase the coverage efficiency of the BS, as well as its processes through more efficient network planning, and therefore needing to spend less energy per customer.

or

- Improve the BS coverage area, so as to be able to serve more users further away.

The network element -level savings is more easily approachable, as usually there are only a few elements within a mobile site to work with (typically only the BS, transceiver and cooling equipment). Of these three, it is the BS that is normally by far the most energy hungry, which also makes it the prime target to focus the energy efficiency research attention on.

The figure 5 on page 26 illustrates a high-level concept map of the relations between energy efficiency and green communications in general. A green communications network consists of different electrical equipment, for instance: network peripherals, customer MTs, cooling systems. By taking advantage of the sophisticated communications technologies (*e.g. smart antenna, ultra-wideband (UWB) communications, adaptive modulation and coding schemes, cooperative communications*), transmission energy efficiency can be substantially boosted. Software and applications in the form of intelligent energy management solutions can also be used to complement the communication technologies in order to further optimise the energy efficiency of the system (*e.g. energy audit and DVS applications*). Network architecture, switching and routing improvements can also amount to a significant wireless energy efficiency improvement due to the decreased network access time, accredited to the higher transmission rates, not forgetting the refinements in the resource allocation and net-

work capacity planning. Hardware plays a key role in the improvement of the overall energy efficiency (Cai et al. 2011).

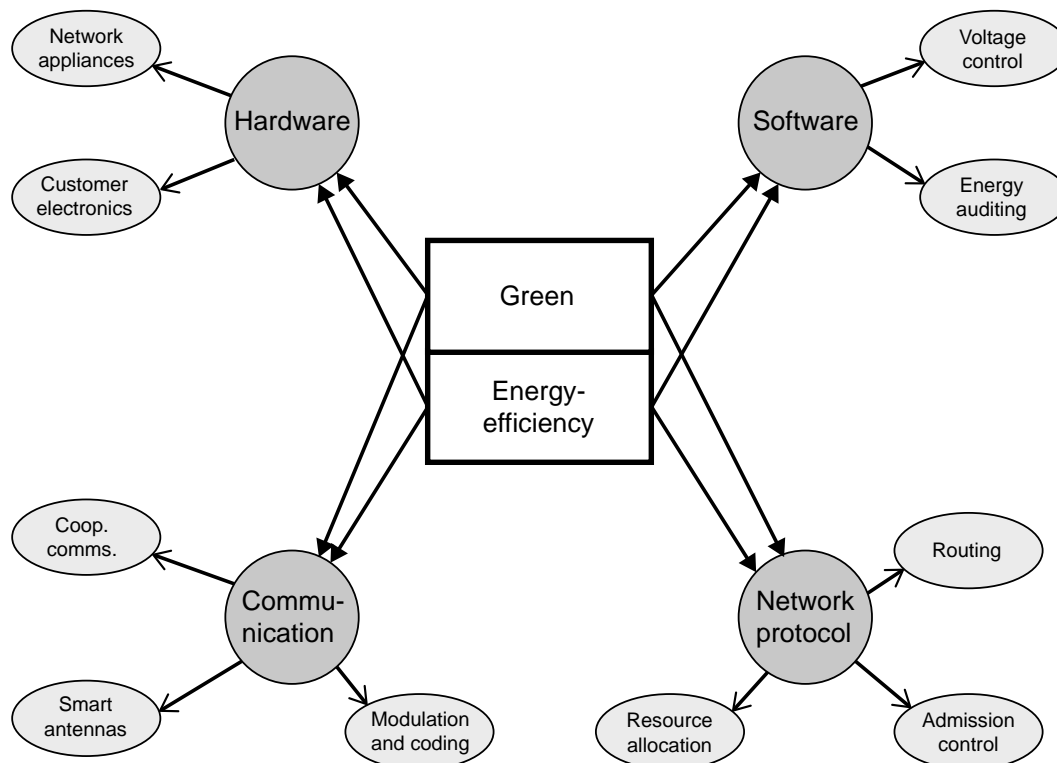

Figure 5. Associations between green and wireless energy efficiency together.

Typically the wireless networks in use today are dimensioned for performance optimisation, with the so-called worst-case network planning philosophy in mind. The philosophy aims to maintain a certain guaranteed QoS at all times, no matter what the traffic in the network happens to be (Niu 2011). Reducing the time the BSs are unnecessarily powered on (*e.g. during a very low utilisation period*) is another key factor in energy savings. Having the unused BS site powered down when not in use obviously saves energy, but it also increases the energy efficiency of the site.

Arranging transmissions to MTs into fewer slots (albeit perhaps at the same time) to reduce receiving energy consumption, as well as an algorithm to find the optimal arrangement of such transmissions into each MTs, in order to reduce MT energy consumption is presented in (Chu, Chen, and Fettweis 2012). A resource on/off switching framework for adapting the energy savings to match to the unstable wireless traffic load fluctuations while maintaining

a preset service quality level was presented in (Ismail and Zhuang 2011). The losses in the feeder, while not being overly significant, still have a profound effect on the BSs coverage capability. The loss of energy efficiency in the feeder is due to the reduction of the power fed from the PA into the antennas. This loss is not overly noteworthy in MTs, as the feeders in them are quite short.

With auxiliary equipment, it is the cooling system that is normally the largest energy user, which is also why the cooling system's energy efficiency is a key factor for energy savings. For macrocell BSs, direct ventilation systems are an efficient way to pump cool fresh air in and hot air out in order to reduce the power demand and thus power consumption of air conditioning systems. Direct ventilation has two characteristic problems:

- The first one being that the battery backup normally has a strict operating and storing temperature range requirement, which is why it doesn't work well in some cases, but this is solvable with the introduction of a battery air-conditioning cabinet that manages the plant's operating temperature.
- The second issue is posed by the air quality, or more precisely, the impurities in the air. In areas, where the air quality is low (*i.e. a lot of dust, smog or other particles*), a *heat exchange system* can substitute the direct ventilation system to help combat the dust accumulation in the ventilation system.

Heat exchange systems have the advantage that the cooling air does not need to enter the equipment enclosure at all, thus isolating the equipment from the coolant, and further minimising the need for manual cleaning and the odds for failures in the cooling system.

3.3 Traffic-Aware Network planning and Green Operation

The term *Traffic-Aware Network planning and Green Operation* (TANGO) refers to a framework aimed at increasing the energy efficiency while also guaranteeing radio coverage and optimising the radio resources. TANGO focuses on switching from always on BS scheme to always available scheme, switching to dynamic cell planning from static planning and switching from uniformed services to differentiated ones. The basic idea is (Niu 2011):

- To only have enough BSs operating at any given time that is absolutely necessary for adequate service quality.
- To utilise cell zooming to influence the cell size according to the prevailing traffic conditions as well as to the situation of neighbouring BSs.
- To delay traffic if possible in order to utilise network resources when they are the most abundant.

The etymology for the neologism TANGO refers to the traffic variation and the adaptation of the available wireless resources into it – a bit like a gentleman (*traffic needs*) and a lady (*power and other radio resources*) dancing together in a harmonious way. More on cell zooming at section 3.9 on page 65.

To be able to relentlessly match the wireless network's traffic variation, and adapt the radio resources (including transmitting power and other equipment's power) in a cell or the whole cellular network, gives possibilities for saving large amounts of energy, as well as for the efficient use of network's resources. In an article (Marsan et al. 2009), a static BS sleep pattern according to a deterministic traffic variation pattern over time is formulated. The article doesn't however consider the randomness, nor the spatial variation of traffic. In an article (Jardosh et al. 2009), a *resource-on-demand* strategy for high-density centralised Wi-Fi-networks was proposed. In the article's strategy, a cluster-head AP is set responsible for taking care of the whole coverage in the cluster in order to be able to switch off the other APs in the cluster as long as the traffic load in the network is low enough. The channel model of a Wi-Fi is however rather different from that of a cellular network, in which the path loss is normally dominant, which is also why a dynamic clustering algorithm considering BS collaboration is needed.

In the articles (Zhou et al. 2009) and (Gong et al. 2010) the authors discussed scenarios in which the wireless traffic intensity varied in both time and in space domains. The latter article also brought up an energy saving algorithm to dynamically adjust the working modes (*i.e. active or sleeping*) of the BSs according to the traffic variation with respect to a certain blocking probability requirement. Additionally, to prevent too frequent mode switching, the BSs were set to hold their current working modes for at least a given interval. Simulations showed that the proposed strategy is able to greatly reduce the energy consumption with a

preset blocking probability guaranteed. In addition, the performance was insensitive to the mode holding time within a certain range.

In an article (Peng et al. 2011), a practical implementation for approximating an energy-proportional (EP) 3G system by using non-EP BS components in order to cope with temporal-spatial traffic dynamics was presented. The article also proposed that the under-utilised BSs were to be simply shut down and restarted again as needed. The network was divided into grids for each of the BSs. Each BS could replace some other BS for serving the MTs. In spite of the significant energy savings gained in the overall cellular infrastructure, the authors also pointed out that the MT's uplink transmission's energy usage during the idle (*e.g. late nights and weekends*) hours was quite adversely affected.

3.4 Different wireless network cell types

This chapter, along with its subchapters, describes the different common BS cell types in wireless networks in use today. In a cellular radio system, the large land area to be served with mobile radio service is divided into smaller and also preferably geometrically regular areas known as *cells*. Generally the cells are hexagonal, as shown in figure 6 on page 32, but other shapes, such as square or circular, are also possible. Each individual cell has their own RBS. A unique operating frequency is assigned for each of the cells (7 different frequencies in figure 6) in order to minimise the possibility for the cells to interfere with each other when in use. Cell blocks using the same set of frequencies are called *co-channel cells*. The interference received from co-channel cells is denoted as *co-channel interference*. One method for cellular systems to increase their capacity is by reusing the same radio frequencies across many cell sites.

In mobile communication, the system has to tolerate with *co-channel* and *adjacent-channel* interference. Co-channel interference happens, when two nearby cells using the same frequency for communication overlap their coverage areas. Co-channel interference would be somewhat tolerable in voice communications, due to the human brain's adaptivity to background noise in normal speech. The same is however not true for data communications, where excess background signals from any other cell, phenomenon known as (*inter-cell in-*

terference) can impair the readability of the electronic message altogether. There are however scenarios, where the situation similar to co-channel interference can actually be beneficial, such as BS cooperation.

Co-channel interference is dealt with by keeping the cells, which aim to use the same frequency set, at a certain distance from each other. This distance is known as *the frequency reuse distance*, or the minimum safe distance between two cells that can reuse the same frequency (in which case the interference from the other cell has attenuated with distance below the SNR to be picked up). The distance is expressed in the number of cells between the two cells sharing the same frequency (V. Kumar 2006).

The spatial separation (the reuse distance) ought to be as small as possible in order for the network to reuse the frequencies as often as possible, thus also to maximise the spectral efficiency. The minimum reuse distance is nonetheless often quite difficult to determine, because as the the reuse distance decreases, the intercell interference increases, and in practice, both of the neighbouring cells experience random power fluctuations due to the wireless signal propagation characteristics (Goldsmith 2005).

Since macrocells are far more powerful than any other cell type, and since they can hence serve a much larger amount of users, why not just use macrocells everywhere instead of any other cell type? One obvious reason is size. A typical Node B is the size of a full sized refrigerator (Motorola 2013a), whereas a picocell can be as small as a desktop computer (Motorola 2013b). It is due to the Node B's size and weight, that the macrocell install site cannot be chosen very flexibly.

Also, the Node B's power consumption and cooling requirements pose some demands to the placement. Node B's typical power consumption can vary between 1-2 kW, (Motorola 2013a), (Alcatel-Lucent 2006), which is why forced fresh air-cooling is thus always required. Flexibility and size are important factors in urban areas, where the lease for a site can be quite high. Node B's are typically quite heavy as well (between 200-500 kg, (Motorola 2013a), (Alcatel-Lucent 2006)) – this also means that the Node Bs cannot be installed without the help of a forklift or a crane.

Picocell's compact size means that they can be installed in locations best suitable for their

signal propagation. For example at a city centre, a picocell might be installed at the street level to provide the best possible signal with the least amount of necessary power. Installation costs are also lower with small cells like femto-, or picocells.

Radio reception is essentially all about the SNR. Signals in the system must be some amplitude above the noise floor in order to be received and processed properly. Even without any external power, all electronic systems (receivers and antennas included), have some inherent noise. As opposed to thermal noise, which can be overpowered by increasing the transmission power (and hence the SNR), co-channel interference can't be mitigated likewise, due to the fact that increasing the transmission power also increases the co-channel interference.

Thermal noise is the noise proportional to electrical resistance and temperature, and it is produced by the random motion of electrons inside the resistors. At all temperatures above absolute zero (*about* -273.15°C), the electrons in the resistor material maintain a random motion. At any given instant there will be a huge number of electrons travelling in all directions (Carr 2001).

In order to provide adequate capacity and good indoors coverage, as well as good call quality for the MTs, a large number of small cell sites must be deployed in the network. The smaller the building and bigger the capacity demand, the smaller the cells being deployed need to be. To increase the size of the mobile phone service area, this cell group can be easily reused over and over again in the area to be served. The expansion is done by locating the cell clusters near each other, as depicted in figure 7 on page 33. Slight cell coverage overlap for the cell clusters is necessary for the service to be gapless should the MT move (handover) from one cell cluster to another.

3.4.1 Small cells

A mobile phone network is built by, *inter alia*, using and combining numerous mobile phone service coverage areas. The vast majority of the current mobile networks consist of the coverage areas served by the network's cells known as *macrocells*. Despite being the biggest and the most powerful cells, even macrocells cannot necessarily serve all of the users in their area. Reasons for the lack of adequate service can be:

- Too many users in a given area (typically in urban area).
- Too poor signal quality in buildings, possibly due to too thick walls, etc.
- Too much interference from neighbouring cells.
- Too great distance between the MT and the BS.

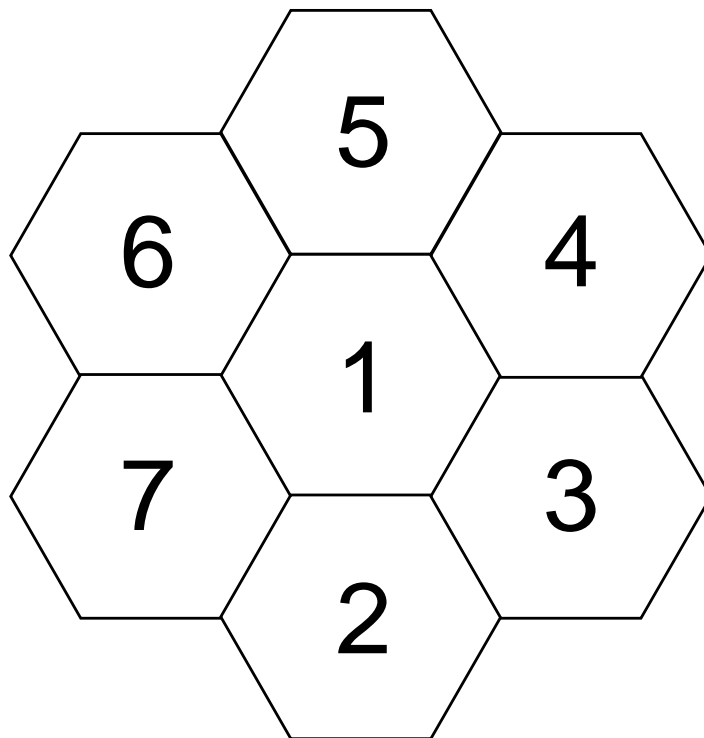

Figure 6. Mobile network cells.

There are a number of different channel assignment strategies for achieving the optimal radio resource utilisation (Arokiamary 2009):

- Fixed channel assignment

The most common algorithm, in which every cell assigns its own RF channels to the different MTs in the cell. All calls within the cell are served by the cell's unused channels – if no channels remain available, no calls can be made.

- Borrowing channel assignment

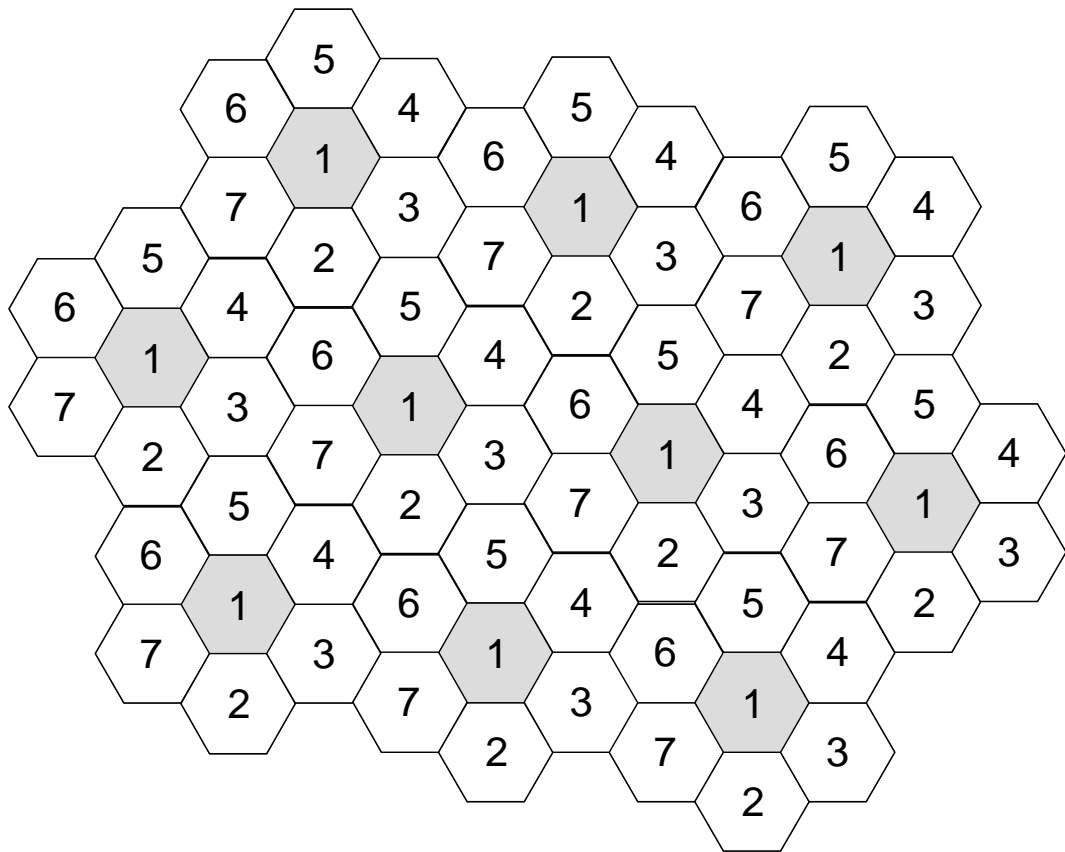

Figure 7. Mobile network cell groups.

Under normal frequency assignment conditions, the borrowing channel assignment uses the fixed channel assignment -algorithm, but if no radio channels remain available, it will borrow channels from its neighbouring cells.

Forcible borrowing channel assignment obeys the rule of frequency reuse distance, and it reduces the need for co-channel assignment in reusing cell patterns.

- Dynamic channel assignment

In dynamic channel assignment there are no fixed channel assignments, instead every time a new call request arrives at the BS, it requests a channel from the wireless network controller. The network controller allocates a vacant channel, which is unused in the specific cell as well as any cell within a preset frequency reuse distance. This algorithm has the added benefit of reducing the call blocking probability, but with the expense of additional complexity.

- Hybrid between dynamic and fixed channel assignments

In this assignment model, some of the channel allocations are immutable, while some remain dynamic (*e.g. GSM/GPRS, where some channels are fixed for voice-only and some channels for data-only -traffic, or UTRA TDD, in which hybrid mode can be used for the uplink and downlink*).

Small cells offload wireless traffic from BSs by overlaying a layer of small cell APs, which actually decreases the average distance between the transmitters and users, thus resulting in lower propagation losses and higher data rates and energy efficiency (Rusek et al. 2013). For the purpose of covering the service gaps in the macrocell networks, smaller network cells have been developed. The smaller cells help not only in increasing the capacity to serve the MTs within the network, but also in the power savings in both the MTs and the BSs as well.

Small cell deployments as well as hierarchical deployments with overlay macrocells have the potential to lead to a situation where a lot of the cells are barely loaded. This applies particularly to situations in which the traffic load varies over the time of the day. Under high load situations, the most favourable solution may be to provide coverage using several small cells, whereas in low load situations, the network management could shut down the cells with only a few users in them. Self-organising mechanisms as well as signalling protocols are required to detect such situations, and to be able to redirect users to other cells, as well as to be able to adjust the network coverage.

The power savings in small cells are essentially due to lessening the need for both the MT and the BS to transmit the signal in high power due to the closer proximity between the cells and the MTs, as well as the cell not (likely) having a neighbouring cell, MT, or both broadcasting at a too close frequency to interfere with its signal.

A small cell is fundamentally nothing more than an umbrella term covering the low-powered RAN cells that can operate both in the licensed and in the unlicensed radio bands. The term is referring typically to a femtocell, picocell, or a microcell⁴. Small cells can normally have a range from 10 m up to 2 km. Many mobile operators are utilising mobile traffic offloading

4. Even the ordinary Wi-Fi (IEEE 802.11) is a subset of a small cell.

as a more efficient use of radio spectrum. Essentially, mobile traffic originally targeted for cellular networks is being rerouted via other, supportive networks in order to transfer the load to a more robust, or uncongested network.

Small cells are compatible with a wide range of wireless technologies, for instance GSM, CDMA2000, TD-SCDMA, W-CDMA, LTE and WiMAX. Such a wide range of choices signifies that there is no distinct technology that is being preferred, and also that there are numerous alternatives for emerging markets (and furthermore that mobile traffic offloading is still only an emerging new technology). The purpose for mobile traffic offloading is also to free the mobile network's resources for those MT's, that for some reason cannot be rerouted to use a small cell (*e.g. the MT is not in the range of any small cell, the small cell is perhaps at it's capacity limit, or the small cell's access is prohibited*) (Wikipedia 2013). More on mobile traffic offloading at section 3.13 on page 85.

Small cell BSs mainly operate in two access modes:

- Open access mode

The BS allows access to all users of the operator's network.

or

- Closed access mode

The BS allows only registered users to access the small cell.

There is also a third mode, called hybrid access mode, in which only a limited amount of resources of the small cell are available to non-registered users as well.

The small cells differ not only in size, but also in their management functionalities too. Femtocells in particular differ from picocells and microcells in the sense that they do not require any self-organising or self-management capabilities. The "plug-and-play" -level ease of use makes femtocells all the more deployable and tempting both in small offices and homes as well – a femtocell can be installed by anyone without any prior computer knowledge.

A common myth in the wireless engineering community is that rain and atmosphere make millimetre-wave spectrum useless and inefficient for mobile communications. However, if one takes into consideration the fact that today's cell sizes in urban environments are on the order of 200 m, it becomes quite obvious that mm-wave cellular technology can indeed overcome these issues (Li et al. 2009). This is accentuated even more with the knowledge that in urban areas the most common cells are going to be small cells anyway, whose coverage areas are not going to be very big in the first place – just around the mentioned 200 m or so. The article also brought up some measurements for rain attenuation and atmospheric absorption characteristics of mm-wave propagation and it can be seen that for cell sizes on the order of 200 m, atmospheric absorption does not create significant additional path loss for mm-waves.

A significant characteristic of small cell deployment is that it is inherently considerably less planned, as opposed to typical macrocellular deployments. For instance, in the case of residential femtocells, the BSs are user-deployed and they support plug-and-play deployment – quite unlike the sturdier macrocells. All of the different mentioned cell types are described in more detail further below.

3.4.2 Femtocells

Femtocells were initially designed to be cheap, low powered and easily deployable small cells with a short service range and a limited number of wireless channels for use primarily in home (ip.access 2013a) and in small businesses ('Nokia Siemens Networks 3G Femtocell Solution' 2013). Femtocells, which operate in the same RF bands as the cellular system itself, and which are typically the size of a home router or a gateway, are installed directly by the end-user in their own premises (*e.g. home or office*), for their own benefit. Femtocells connect to the operators network via the user's existing regular wired Internet access line. Existing home routers cannot be modified to act as a femtocell, but instead there are femtocells with both a DSL router and femtocell functionality. A femtocell's range is in the order 10 metres or less.

Femtocells provide convenient means for the network to reach its users with comparably low

effort (especially compared to larger cells, like macrocells), due to the fact that femtocell BSs are located closer to the user than the macrocell BSs are. This means that femtocells can thus operate at a lower RF-power, and can also support more sophisticated modulation schemes. The more sophisticated modulation schemes are attainable due to the fact that femtocell's users are typically closer and hence relatively unobstructed to the BS – which in turn means that it is less likely that there will be much of a disturbance to the signal. In essence, the intention is, that the signal wouldn't have to be "blasted" from the RBS through the building's walls from a distance, but rather it could be transmitted quite close to the femtocell user with a relatively lower power.

Furthermore, femtocells may be switched off in the case that there are no users requiring the service, or if there is sufficient redundancy in the network to handle all of the concurrent users. Naturally, this too requires some signalling overhead (and thus time and energy) between the cells to make the shutdown decision. One main motivator to use femtocells is to improve the RBS's energy efficiency under high traffic load situations, and to enable it to achieve high bit/s/Hz/km² data transmission link throughout the network. If the network's femtocells are powered by sustainable energy sources with diverse amplitudes, it is essential to resolve the correct femtocell size and adapt the femtocell to the varying energy charging rates and traffic demands of the network in order to ensure high-energy sustainability.

The risk of having multiple femtocells interfering with each other is further mitigated by the fact that femtocells have a very limited RF-power output, and hence they have a low chance to disrupt any neighbouring cell's service. According to the Small Cell Forum ('Small Cells, FAQ' 2013), femtocells have already been implemented into use by a number of wireless operators around the world. This macrocell – femtocell (or macrocell – small cell) architecture is especially beneficial to those users near the macrocell's edge due to the capability for the macrocell to extend its wireless coverage to the remote users by delegating its network coverage responsibility to the small cell. This co-operation scheme has also the capability to save power in both the MT as well as in the BS.

Femtocells are intended to be much more autonomous than picocells. When the MT arrives into the coverage area of the user's femtocell, the MT switches from using the macrocell network to the femtocell network automatically. Femtocells can automatically determine

which frequency and power levels to operate at for sufficient service quality. This allows the network to adapt to the changes automatically as new femtocells are added or moved, without the need for a complete frequency re-planning. As a disadvantage, femtocells do not normally broadcast a list of nearby neighbouring cells. This leads to the MTs having to maintain the connection to the one individual femtocell as long as possible, even if there would be an alternative, better quality network available (*e.g. a macrocell*). This increases the risk in dropping the network connection, and also the call (Chambers 2008).

3.4.3 Picocells

A picocell is typically a low cost, compact and comparably simple device (ip.access 2013b), which connects traffic to the BSC to be further handled and routed towards the MSC and SGSN. Picocells are often designed to be small enough to be installed, and lightweight enough to be delivered by a one technician only. Oftentimes the network operator pays for the installation site's rental and electricity bill, as well as for the network connection and device maintenance costs (Chambers 2008).

A picocell in cellular networks (*e.g. GSM, CDMA, UMTS and LTE*) is typically deployed to extend and complement the coverage of a macrocell in areas where the wireless signal coverage is normally poor, or into areas where it can be expected to be able to serve a large number of MTs on behalf of the macrocell (and thus offloading the traffic from it). A picocell's typical range is in the order 200 metres, or less.

Picocells can achieve many of the similar benefits of the other small cells – they can improve the data throughput for the MTs while alleviating the capacity issues in the mobile (macro-cell) network. The seamless handoffs provided by the heterogeneous network, also known as a *HetNet*⁵, between the macrocells and picocells are crucial in increasing the mobile network's capacity. HetNets are also referred to as *multi-tier networks*, with the macrocells being the first tier, and the picocells or femtocells the second tier.

The introduction of picocells should come hand in hand with some sort of macrocell energy management solution, such as the capability to switch off the macrocells (or to use sleep

5. A network connecting either picocells or femtocells in the coverage area of a macrocell.

modes or cell zooming), otherwise picocells would only increase the energy requirements (as well as the capacity) of the wireless network in the form of over-provisioning⁶. This also leads to the increase in the probability of under-utilised macrocell BSs.

It doesn't matter whether it's used in a cellular or WiMAX -network, the picocell should ideally support multiple wired and wireless backhaul options (*e.g. ATM, E1/T1 or for instance GigE*) in order to add robustness in case the primary link fails (R. Kumar 2013). In the article (Wang and Du 2011), the authors analysed the possibilities to cancel out the macrocell BS's signal in the coverage area of a picocell in a HetNet-environment in order to improve the picocell's performance, as if there was no macrocell BS in the first place. The authors also assessed the downlink performance gains of HetNets with open-access picocells.

In the article (Saker et al. 2011), the authors evaluated the energy efficiency effect of a picocell deployment into a macrocell (LTE-A) network (effectively a HetNet), and deduced that picocells can indeed be a beneficial addition into an existing macrocell network from the performance and capacity point of view. The authors of the article (Claussen, HO, and Pivit 2008) discussed the same energy efficiency issue of a joint deployment of a picocell and a macrocell network, and concluded, that up to 60% energy consumption reduction is attainable in urban areas with this technology, and suggested also that the energy efficiency will further increase in the future as the technologies mature and develop further. Interestingly, the article also calculated a maximum number of picocells, with which the network's energy efficiency is maximised (at 20% network wide deployment ratio). The article (Saleh et al. 2012) approached the energy efficiency issues of picocells, relays and macrocells, and concluded through simulations, that relays and picocells both provide positive energy efficiency gains in uplink, but for the downlink scenario these approaches (rather surprisingly) provide however quite differing energy efficiency gains. For downlink, the relay nodes produce similar throughput power consumption as macrocell deployments.

6. The term refers to the situation of having too much capacity in a wireless network.

3.4.4 Microcells

A cell served by a low powered cellular BS covering only a small area in a mobile phone network is called a *microcell*. Microcell's size lies typically in between the larger metrocell and the smaller cells, like a picocell, although the definition is not always exact. In some (earlier) literature, microcells were discussed and modelled as picocells are today (Greenstein et al. 1992, in which macrocells were actually only about 1 km in radius), whereas in some literature (Wu, Chung, and Sze 1997), macrocells were described as being the union of many equal microcells.

Just like with femtocells and picocells, microcells too are used to complement the larger macrocells in capacity and in in-building penetration in areas with very dense cellular phone usage. This also alleviates the macrocells burden by offloading some of the MTs away from it ('Nokia Siemens Networks Flexi Lite Base Station' 2013).

The article (Moungnoul and Pongsuwanporn 2007) analyses the possible wireless interference factors between macrocells and microcells, as well as the network capacity benefits gained from such cooperation. In the article it is shown, that the intercell interference decreases if the microcell is moved away from the centre of the macrocells centre, and if the radius of the microcell is reduced.

3.4.5 Metrocells

Metrocells are compact and discrete BSs deployed to help provide supplementary capacity for urban hotspots, as well as to improve the wireless coverage in indoor locations and extend network coverage and capacity to rural locations. They can also be deployed in high-traffic locations to offload traffic from heavily loaded or saturated macrocell BSs. Typically, when used to enhance the capacity of urban hotspots, metrocells can be deployed in selected high-traffic locations, such as city centres, train stations or shopping malls. Nonetheless, the exact definition of a metrocell varies considerably in literature. Usually however it is used to denote a small cell of some kind, deployed into a larger macrocell network (*cf. HetNets*).

In order to better the wireless coverage for indoors, metrocells can be deployed within convention centres, hotel lobbies, shopping malls, hospitals or offices. They can also be targeted

at areas with poor or non-existent macrocell coverage in order to provide superior indoor cellular coverage with a lower TCO than with a macrocell alone. The economic benefits, or returns, of using a metrocell scale by the amount of percentage of offloaded wireless traffic from the macrocell network – and also by the used macrocell network frequency band. Metrocells are however rather limited in the amount of users per cell and in the cell range, but then again the BS power requirements are also much lower.

3.4.6 Macrocells

Macrocells are the original, wide range, operator-owned and maintained, high power BSs, which cover very large areas, up to 30 km in radius (depending on the propagation conditions) (Chambers 2008). Macrocells are typically placed so that they have the potential to serve users in as wide range as possible (although not necessarily simultaneously), for example in rural areas or along motorways. A macrocell BS consists of a macrocell processor and a macrocell antenna tower, and while having a very large service radius, and a potential for a large amount of users, their downside is (at least comparing to smaller cells) fairly poor building penetration capability and thus lower data rates for those users. Also, the large service radius can produce interference with other nearby BSs, which is a lot harder burden to combat compared to smaller cells. Each of the cells are configured with their corresponding neighbour lists, so that their MTs can attempt to switch over (migrate) to an appropriate nearby cell, if necessary, and continue operating without any service interruption.

Macrocells have the characteristic property of being good at providing wide area coverage, but they are not as effective in providing high-speed data per area due to the large coverage they yield. There are propositions to replace the macrocell antenna with multiple microcell antennas, which are in turn all connected to the macrocell controller, in order to reduce the intercell interference in a densely populated environment, as well as effectively turning the macrocell into an diversity system (Xie et al. 1994, this technique has later on evolved to the direction of small cells).

Plenty of research articles concerning the sharing of the wireless spectrum with femtocells and macrocells, as well as the cancellation of the interference in the said circumstance ex-

ist (Alexiou et al. 2011, especially concerning the interference), (Ndong and Fujii 2011, an interference mitigation scheme through the network’s infrastructure), (Zhou and Ma 2011, especially about femtocell uplink transmissions with co-channel interference from the macro-cell users, as well as a solution and simulations to avoid the issue), for the resource reuse schemes for cellular networks with coexisting femtocells and macrocells (Shi et al. 2010) and spatial multiplexing, (Adhikary and Caire 2012, in which the macrocells and femtocells downlink and uplink are interleaved). Figure 8 on page 42 illustrates the various cells and their corresponding intended uses.

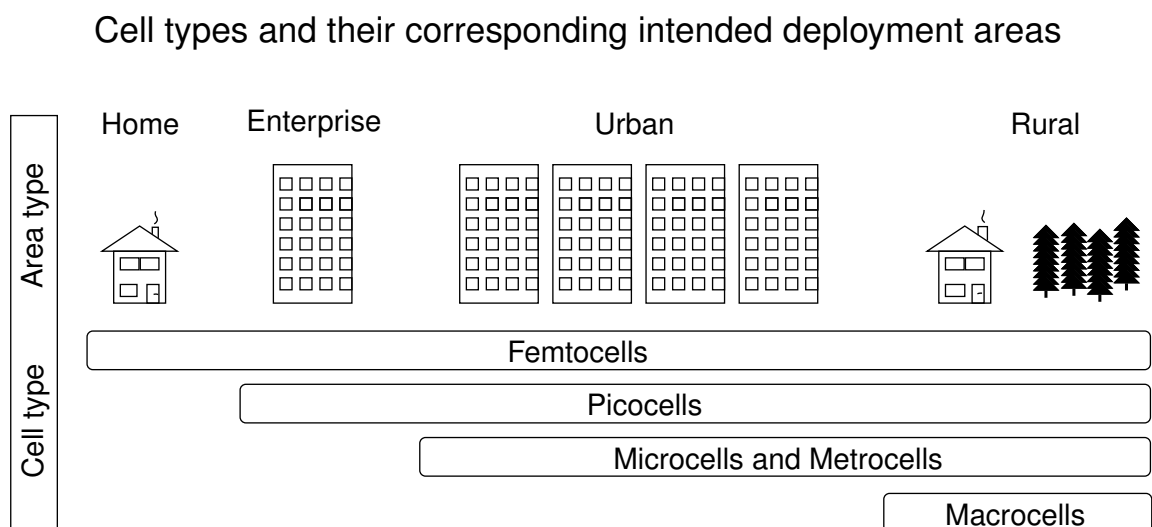

Figure 8. Cell types versus their intended uses.

3.5 Beamforming

Beamforming (*or spatial filtering*) is a form of wireless signal and antenna management, where multiple *omnidirectional*⁷ antennas are used as one to send out the same signal with differing magnitudes and phases in order to cause constructive electromagnetic interference⁸ to simulate the selectivity and gain of a much larger directional antenna. The simplistic illustration 9 on page 43 represents the three major types of antenna radiation cones into which the radiation spreads. Figure on the left represents an omnidirectional antenna, in

7. Omnidirectional refers to the notion of radiating in every direction, (*i.e. non-directional radiation*).

8. The physical phenomena behind this are far beyond the scope of this thesis.

which the radiation spreads (ideally) evenly into all planar directions, in the middle is a sectorised antenna in which the radiation is focused into a shape of a cone (in this case a 120° wide cone), and in the image on the right the radiation is focused into a narrow beam.

The purpose with beamforming is also to point the constructed signal strength maximum electronically at the desired receiver's antenna without actually moving the antenna array itself. Often times the antenna movement is not even an option, or the movement would be either too slow or cumbersome. The constructive interference brought up by this technique also helps minimising the signal propagation in unwanted directions by cancelling the signal at certain directions (*e.g. neighbouring cells*).

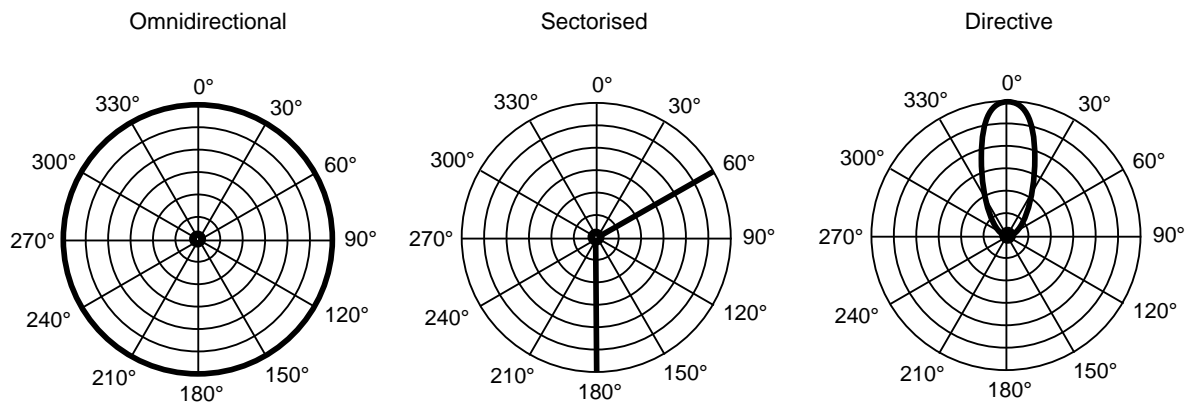

Figure 9. Illustration of different antenna radiation zones.

The antenna array's amplitude and phase shift together can be used to adjust the side lobe levels and steer nulls⁹. This combined relative amplitude and phase shift for each antenna is known as *complex weight*. A *beamformer* applies the complex weight to the signal to be transmitted for each of the antenna array elements individually. The easiest (and consequently a very static) way to control the signal's phase is to vary the feed cable lengths to the antennas. Cables introduce delay (and not to mention losses) into the signal, and it is this delay, that causes a phase shift (Haynes 1998). Electronically the same phase shift can be achieved by using programmable electronic phase shifters at each of the array elements. Digitally this can be achieved by digitising the signals (with an A/D converter) and using

⁹ The cancelling of an interfering signal in a multiuser environment, due to the antenna reception minimum at a specific direction.

a DSP. In (Qamar and Khan 2009) the authors analysed the performance of null steering, ran comparisons between several different common null steering techniques, and ultimately found that null steering by real-weight control ranked highest in the comparison.

Beamforming can help increasing the overall transmitter energy efficiency by focusing the antenna array's radiation maximum at the direction of the intended receiver. This constructive increase in the signal strength means that the signal can be received with relatively less transmitted power compared to using a more traditional sectorised antenna¹⁰, technique known as *collaborative beamforming*. Moreover, a collaborative beamforming antenna array can help the signal to travel farther compared to an individual antenna from that array.

Beamforming efficiency itself is highly dependent on the received electromagnetic wave phase differences. The efficiency is at 100% when the antenna phase difference is zero degrees. Furthermore, two signals cancel each other when there is a 180° phase difference between them (Feng et al. 2009).

Collaborative beamforming means that the combined signal transmit power can be reduced in the entire antenna array compared to a single sectorised antenna, without overly impairing the received signal quality (Feng et al. 2010). This decrease in transmit power combined with a highly focused radiation beam together with its steer nulls help further decreasing the possible interference in nearby transceivers (*e.g. MT or BS*).

The peak beamforming gain (G_b) can be estimated by enumerating the number of antenna elements N_a in the array. For example, a 16-element antenna array (*e.g. in a 4 x 4 configuration*) is capable of providing roughly 12 dB of peak beamforming gain (G_b [dB] = $10 \log_{10} N_a \Rightarrow 10 \log_{10}(16)$). Placing such antenna array into the receiving end as well can result in combined 24 dB gain, as noted in (Perahia et al. 2010).

Figure 10 on page 45 represents an antenna array of four elements set in a row with a transmitter feeding the power splitter. The antennas here have a $\lambda / 2$ phase difference between each other, totalling a 1.5λ phase shift. The illustrated antenna array can produce a phase shift in two dimensions only (planar, or parallel to the array). The array needn't be in a row of course (or in a circle for that matter) – nor do the array elements need to be at an even

10. An antenna with the selectivity lobe focused into a sector.

distance (at the same relative phase shift) from each other. As an example of this, figure 11 on page 46 illustrates an unevenly filled spiral antenna array with a transmitter and a power splitter feeding each of the antenna elements in a similar fashion as in figure 10. The array can be formed at different heights as well, so as to give a third dimension (a normal axis compared to the row) to the beamforming as well.

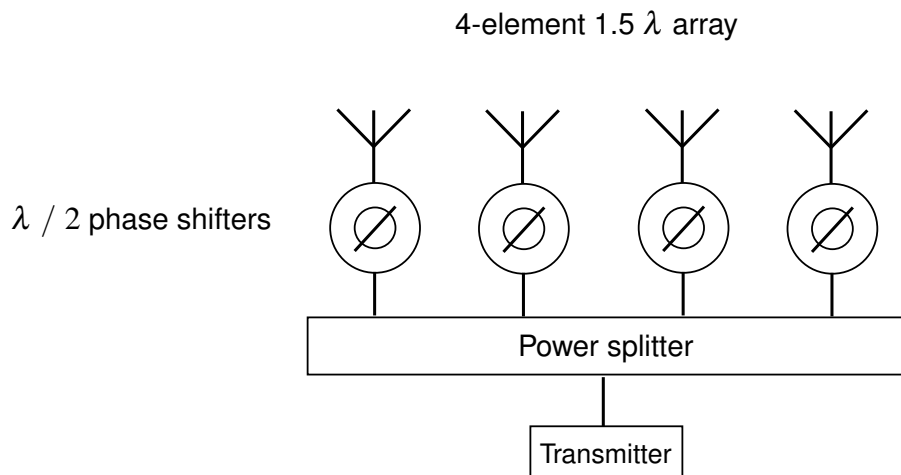

Figure 10. 4-element antenna array with a $\lambda / 2$ phase difference.

The process of selecting the complex weights seamlessly in real time such that the quality of the signal is constantly at a maximum, is known as *adaptive beamforming*. As its name implies, an adaptive beamformer is able to automatically adapt its response to the varying radio situations (Veen and Buckley 1988). If the complex weight -settings are pre-calculated and stored in a library to be selected and applied as required, this process is called *switched beamforming*.

In switched beamforming, the BS essentially just chooses a complex weight preset from a library of presets according to the measured RSSI value (Altera 2011). If the target is mobile, the BS would reassess the suitability of the preset according to the present conditions, and select another preset if deemed necessary.

Commonly used methods for selecting the complex weights are:

- Minimum Mean-Square Error

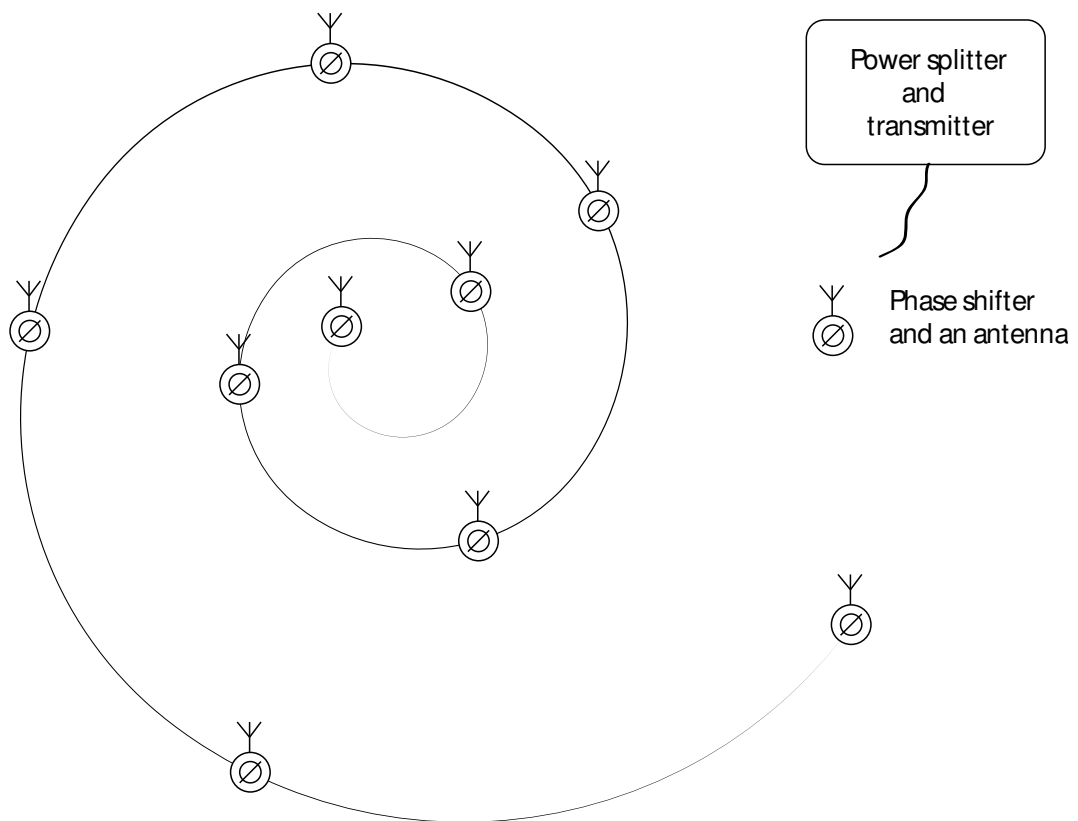

Figure 11. 9-element antenna in an uneven spiral array.

The desired received signal waveform shape is known, so the complex weights are modified in order to minimise the quantity of mean-square error between the beamformer output and the expected received signal waveform.

- Maximum Signal-to-Interference Ratio

The transmitter estimates the strength of the desired signal, and that of an interfering signal and applies the complex weights to achieve a maximum ratio for them.

- Minimum Variance

If the signal shape and direction of the source is known, the complex weights are calculated such to minimise the noise from the beamformer.

Adaptive beamforming systems are also known as *smart antenna systems* (Goldsmith 2005), or *MIMO-systems*. There are further applications for such systems for instance in the military,

where the enemy's radar jamming signal can be minimised by carefully choosing the smart antenna array signal minimum (as well as a proper adaptive beamforming algorithm) towards the position of the jamming (enemy) signal (Griesbach and Benitz 2013), while setting the antenna array's main lobe towards the communicating party.

Another possible use case would be for a mobile phone BS to use adaptive beamforming in order to serve two or more MTs at the same frequency at different directions (effectively splitting the cell into multiple sectors and using sectorised antennas within), process known as *Spatial Domain Multiple Access (SDMA)*. SDMA works by steering the individual signal lobes at each of the users (MTs), as shown in figure 12 on page 47. Should the users become too near to each other, frequency reuse would not be a viable option anymore, as the signals would leak to the other user(s).

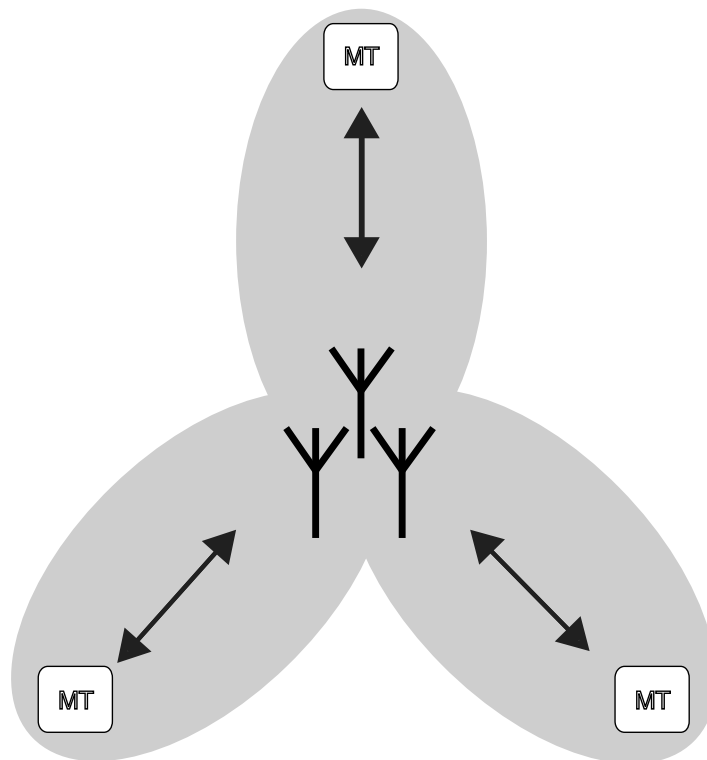

Figure 12. 3 SDMA radiation cones aimed at different directions.

3.6 Cognitive radio networks

A cognitive radio (CR) can be described as an intelligent adaptive wireless transceiver with reconfigurable hardware and software, capable in adapting to the varying radio conditions in which it is used. CRs work in cognitive radio networks, some of which can be allocated to use the licensed frequency spectrum. Because of the fact that the available (feasible) wireless spectrum is a limited natural resource, and the fact that the amount of wireless devices in the bands are continuously increasing, these bands are becoming more and more congested with traffic. However, unfortunately up to 90% of the time, these licensed bands are unused (Devroye, Vu, and Tarokh 2008).

Because the already licensed wireless bands are difficult to legally reclaim and release, several devices must thus sometimes share a band from the same spectrum. To alleviate the congestion, negotiable sharing has been implemented by allocating the given band to be used by several types of users – most often for only to the primary (the band’s license owner) and the secondary users (other users, in this case the CRs).

Having enough intelligence to detect and avoid using other users’s frequencies, the CRs as secondary band users, can thus avoid causing interference to the primary users in their bands, thus simultaneously increasing the usage and efficiency of the bands. The term cognitive itself can be thought to refer to the intelligence to avoid interfering with any other traffic, while the interference refers to the restraint on the system’s capacity as well as the performance of the individual radio links, as well as to the hindering of the quality of the communication links.

To avoid, or at least minimise the interference to the primary, higher priority users in the band, the CR transmitters can:

- Sense (or more specifically, listen to) the spatial, temporal, or spectral voids (white space) in the bands, and adjust the transmissions to occur (in orthogonal) in those voids, and stop transmitting if the primary users’s traffic resumes again.
- In the case, where some interference to the primary radio *can* be accepted, sense the maximum possible transmission power level with which it can transmit without ac-

tually causing such a notable interference to the primary users to cause too much of a service degradation to them. The maximum interference level is typically defined as *interference temperature*, where the temperature corresponds to the average power level of interference detected at the primary receiver's radio. The maximum allowed temperature levels can be pre-negotiated with each party to allow uninterrupted service for the primary transceiver, and at the same time maximum possible service for the band's secondary users (the CRs).

- Utilise the knowledge of the interference temperature, and the transmission codebook of the primary transmitter (so as to be able to decode their message), and to decode and reduce the primary transmission from the transmission channel, thus effectively clearing the channel from the primary transmitter's message. This technique, known as *Opportunistic Interference Cancellation* (Popovski et al. 2007), enables the secondary transmission to be conducted more effectively, thus essentially creating a multiple access channel.
- By combining the knowledge of the interference temperature and the transmission codebook of the primary transmitter along with the knowledge of the actual transmitted message, the CR can form asymmetric, non-causal transceiver cooperation between the primary and cognitive transmitters (Devroye, Mitran, and Tarokh 2006).
- By imposing explicit distance limits between the secondary CRs and the primary users, in a such way that the CRs must at all times keep a certain minimum safe distance from the primary network in order to minimise the inflicted disturbance to it. This is particularly useful for instance in TV networks, where there is (typically) only one transmitter nearby, and many receivers – the CRs cannot know where the receivers are, so they all need to keep a certain safe distance (radius) from the TV network's coverage altogether. These kinds of exclusion zones for the secondary transmitters have been proposed to be used with the TV band by the FCC (Marcus 2005).

There are many reasons for the existence of the white space brought up in the aforementioned list:

- The large peak-to-average *use* ratio of many of the systems that have spectrum dedicated for them (*e.g. public safety MTs*).
- Spectrum assignment limitations designed to accommodate practical receiver sensitivity, for instance adjacent channel and image frequency rejection.
- The population (and hence the mobile traffic) is not uniformly spread.

Elementary versions of the CR technology have been utilised for several years. For example, many cordless telephones select their frequency according to the environment, such that the channel they use would be as much interference free as possible (Marcus 2005). Also, even many of the run-of-the-mill home Wi-Fi routers can sense their wireless environment and choose the best Wi-Fi operating channel, so that the channel has the least background noise and the best performance.

FCC has released a proposal for the secondary CRs to find out if the band is available for them to use at a given place or not by (Marcus 2005):

- Sensing the band passively for signal before attempting to broadcast (so-called *listen-before-talk -scheme*).
- Geolocation, followed by a check against a database to see if there are any transmitters nearby, and also to find out which frequencies are thus not available. GPS has unfortunately known locating issues indoors (the GPS satellites are not necessarily always reachable).
- Transmitting separate beacons that would indicate the used bands in the wireless coverage area.

In (Tran, Zepernick, and Phan 2012) the authors analysed the impact of distances among the users and the number of antennas on the system performance of a single-input multiple-output cognitive radio network. The authors, while assuming that the secondary transmitter was equipped with a single antenna while the secondary and the primary receiver both had

multiple antennas, noted that the system performance not only depends on the distances among the users, but also on the number of antennas at the secondary and the primary receiving user's radios.

Those CR slave nodes in WDC networks that are the closest to the master node need to use comparably less radio transmission power in their communication link compared to the nodes that are further away. The power savings from the close proximity communication link are thus available for the network's computational tasks. This leads to the situation where the slave nodes closest to the master node are also computationally the most efficient (Datla, Volos, et al. 2012).

3.7 Wireless Distributed Computing

In distributed computing, traditionally the computing problem is divided into many tasks, each of which is solved by one or more nodes in the distributed system. In this type of computing model, each networked computing node must be able to communicate with each other. A WDC system is a system that consists of a number of radio nodes that can communicate with each other through a wireless network to share the tasks to be solved. The nodes interact and communicate with each other in order to compute a commonly assigned task.

A cognitive radio is an autonomous transceiver that can adapt its behaviour to the varying radio conditions, as it deems necessary. It can adapt its internal parameters for achieving the optimal communications performance, and it can be used for WDC applications. An individual CR node does not necessarily have the computational power to perform the WDC tasks by itself, which is indeed the core reason for joining the nodes together. More on cognitive radios at section 3.6 on page 48.

Each node in a WDC network incorporates the communication, computational, and power subsystems. The communication subsystem is the subsystem responsible for connecting the computational subsystems on the various collaborating nodes through the wireless links. The communication subsystem is also responsible for serving the distributed computing nodes the computational workload. In addition it also handles the message passing between the computational processes on the different nodes (Datla, Volos, et al. 2012).

WDC exploits the wireless connectivity in its CR nodes for sharing the processing-intensive tasks with them. The goals in WDC are to reduce the per-node and network resource and energy requirements, and to enable the execution of computationally complex applications not otherwise possible (*e.g. image processing in a network of small form factor radio nodes*). WDC allows these constrained and computationally often quite limited CR nodes to collaborate and share the tasks amongst themselves. By sharing the tasks in a network of available processing nodes, WDC also adds robustness into the computation network. Should a node deplete its energy resources, or should it lose its network access for any other reason, the network nor the task or the data the nodes are processing are stopped or lost.

The added robustness and flexibility are somewhat negated by the overhead caused by the network communication, as well as task and data delegation between the network nodes. The achievable energy savings in the WDC network do not scale linearly with the assigned workload, due to the fact that if some workload gets delegated onto multiple network nodes (from master node to slaves), the delegation, despite being beneficial from energy efficiency standpoint, inherently causes some communication overhead as well under a uniform load balancing scheme (Datla, Volos, et al. 2012).

The non-linearly increasing communication overhead poses limits to the size of the network scaling. In an energy-constrained network, the communication overhead causes the network nodes to lower their CPU's clock speed in order to meet the capacity of the energy supply (Datla, Volos, et al. 2012). There may also be power constraints (*e.g. renewable solar, or wind power*), which would impose limits to the available energy that could be afforded to be spent in a specific task, or even limit the available schedule for the execution of the task (*e.g. night vs. day*). Relative power savings cannot be attained at all from a WDC network, if the communication overhead gets bigger than the computation power consumption.

The nodes, whose wireless communication channel conditions are poor, must spend more power to establish and maintain functioning and reliable communications links. To paraphrase, the more power is consumed in the communication link, the less power is left for the actual computing. Hence the total computing capacity of the cluster node is determined by the maximum available computing power for the node sans the power required for the communications link. Lower available power for the network nodes can lead to weakened

network computing capacity (X. Chen et al. 2009).

The mutability of the communication channel quality impairs the reliability of the network. In WDC, maximum delay is the property responsible for determining the overall delay performance, as opposed to the average delay in more ordinary digital wireless systems. Distributing the workload according to the channel variance may help to increase the energy efficiency and to decrease the vulnerability to the channel delay variance by reducing work from the node in the channel with a large delay variance. Removing the nodes with the worst radio propagation channels altogether can have the potential to enhance the network's energy efficiency even more.

WDC can help achieving several advantages compared to more traditional, local sequential computing, such as:

- Computational performance
- Scalability and flexibility to adapt to varying channel conditions
- Fault-tolerance to dropped network nodes with unfinished delegated tasks or data
- Load balancing

Should the node deplete its energy reserves while computing a task, it can offload its task and data on to another node.

- Cost effectiveness

The capability to only select the nodes whose energy supplies are the most abundant, or the ones whose computational efficiency is the highest for the specific task.

In addition to these obvious benefits, in some cases WDC is also the only possible technique to access multiple independent or distributed data sources (*e.g. military sensor nodes or weather station sensors*).

3.7.1 Wireless network distributed computing

In a Wireless Network Distributed Computing (WNDC) -system, each node essentially comprises only of the power supply and the communications and computation subsystems. The communication subsystem is the subsystem responsible for connecting the computational units in the nodes across the wireless network. It is also the path through which the computational tasks and the data in the nodes are disseminated throughout the network. Under the optimal conditions, a WNDC system can execute a computational task with a lower power consumption compared to a single, higher performance node, despite having the burden of communicating with the network (Datla et al. 2009).

In a Wireless Distributed Computing Network (WDCN), the service nodes provide computing resources to a client node. The client node is responsible for distributing the work to its service nodes for processing. The WDCN computing task gets completed only after all of the data has been processed by the service nodes and only after all of the data has been sent back to the client node. It is the maximum execution time among the WDCN nodes that determines the total execution time of the computing task (X. Chen et al. 2009).

In the WNDC nodes, the communication and computation processes can occur either:

- In parallel, so as to comply with the node's resource or the network's latency constraints.

or

- In non-overlapping time intervals, in order to meet the node's power constraints.

For a set of WNDC nodes identical in computational capacity with a finite set of computational tasks, any computational power consumption savings achieved by distributing the workloads are negated by the communication overhead. This means, that in order to maximise the power savings, the communication power consumption in each WNDC node must be minimised. This can be achieved by using both an appropriate transmission modulation scheme, as well as an appropriate communication system bandwidth to meet the communication latency constraint set for a particular transmitter-receiver distance.

A WDC system can operate in either of the two modes (Datla et al. 2009):

- Power reduction mode

Appropriate when the latency requirement is met by a single computing node, however it's power consumption exceeds the power constraints. This is also why, after a uniform workload allocation, the tasks are divided to each participating network node with a lower CPU clock rate.

or

- Computational latency reduction mode

In which the individual nodes operate without clocking the processor down. This mode produces negative power savings, but also the best possible computational performance.

A hybrid situation between these two is when an individual WNDC node faces both power supply and computational latency constraints. This can happen when the node gets a task with a too high computational latency requirement to meet with its own processor and power supply, or a preset power constraint. In this case, the node can share its computational workload with the network. The collaborative work is being completed with in accordance to the set power constraints, as well as to the computational latency limitations.

When the communication overhead begins to dominate the computation power consumption, the WNDC power savings begin to vitiolate away. This can happen in the case when there are too many nodes assigned to a task compared to the task's computational complexity. This is also the point, when the communication power actually negates the computation power reduction, and thus negative energy savings are produced. WNDC excels in a scenario when a complex CPU intensive computation is executed on a short-range simple transceiver network (Datla, Chen, Tsou, et al. 2012). The amount of networked wireless nodes and their distances were evaluated against the energy efficiency gained from such a situation in (He et al. 2011). For energy optimisation, a peak value for the number of nodes for said distances was found in the mentioned article, at which the WDC network still remains favourable

choice over on-board processing.

DVS is another method that can be considered for increasing the power efficiency of the CPU in the WDCN nodes. Adaptive power control on the other hand can be used to adapt the transmitter power to the prevailing radio channel conditions. If the channel quality is poor, more transmission power is needed for the link to be reliable and to meet the required threshold of transmission errors as well as retransmissions. Once the channel quality improves, the transmission power can be throttled back again to save power. The wireless channel conditions may however be bad enough that some nodes might not even be allowed to join the WDCN at all. In poor radio channel conditions, it might be better to not to allow some of the nodes with worst radio links to join, and to rather take the performance and energy efficiency penalty voluntarily, than to allow the nodes behind the poor channels to try to join and participate in the WDCN with relatively high transmission power.

Another possible solution to combat against bad wireless conditions would be to allow even the nodes behind bad channels (high channel variation) to join the network, and choose the best ones from the pool of nodes to distribute the work onto, and disconnect the rest of the nodes away from the network. This option is also computationally quite straightforward to implement.

The transmission power must match the prevailing radio channel conditions and variations in order to ensure that the communication link is reliable and of adequate quality. This uncertainty in channel conditions combined with the finite energy resources results in having rather unpredictable computing power reserves, as well as random fluctuations in the task processing power and time. This is due to the fact that the transmission and computing power are constrained to be the sum of the total energy supply available in each of the individual nodes. If either the computing or the transmission power requirement increases, the power reserve for the other decreases.

The option to balance the transmitter power at the threshold of sufficient reception quality along with the decision of the optimal power allocation scheme to match the adequate delay requirements, helps the network simultaneously to save power as well as to keep the robustness of the network at a reliable level. It is however possible to mitigate the impact of

radio channel quality variation on the delay performance and energy efficiency by assigning more work to the nodes whose channel quality is the best (X. Chen et al. 2009). It has also been shown that overlapping the computing and the communication processes can further improve the power efficiency of the iterative, clustered computing jobs (LaDuca, Sharkey, and Ponomarev 2008).

3.7.2 Mobile agents

Computer programs that execute in contexts called *places*, are hosted on different computers, and that can autonomously travel from place to place resuming their execution there, are called mobile agents. Mobile agents are not bound to the computer where they were initially created, but they are designed to be able to migrate freely across the network into other computers, or other computing nodes, and transport their state, data and code with them to another execution environment in the network, so as to resume the execution there. Their roaming nature, autonomy and adaptability to often-volatile radio conditions can be beneficial in distributed computing environments, and they can have a positive effect on energy efficiency on the network they reside on.

Mobile agents in general should be as small as possible due to the fact that their size has a major affect on the cost (in terms of transfer size) of migrating them over a network. Mobile agent -based distributed applications should be designed to utilise different agents specialising in their particular tasks only, as opposed to having general purpose agents for executing universal tasks. The mobile agent -based distributed applications should also be able to select suitable agents to perform the tasks (Satoh 2004).

Mobile agents can help minimising the energy consumed in the network's radios by having the capability to migrate themselves to wheresoever the data to be processed is, rather than moving the data over to them for processing. Mobile agents are in a way a method to encapsulate and outsource the tasks away from the user, and while doing so, they also alleviate the impact of network latency on the user. They are asynchronous and autonomous by design, meaning that a device (*e.g. the mobile phone*), can issue a mobile agent onto a computer in a fixed network to run, and then go off-line itself. Once the mobile device connects to the

network again, it can retrieve the processed data from the agent.

Mobile agents can alternatively be utilised to push the tasks and data to be processed onto several other clients or agents, so as to perform the task in parallel (Lange and Oshima 1999). For a mobile agent to be able run and execute, it requires a mobile agent platform. Several different platforms have been evaluated for their performance and reliability in (Trillo, Ilarri, and Mena 2007) and in (Altmann et al. 2001).

Some criticism about mobile agents have also emerged in (Vigna 2004), (Samaras 2004) and in (Bobed, Ilarri, and Mena 2010), all promptly pointing towards the fact that mobile agents are still quite an immature technology, and that it still needs further research and development. Main points for the criticism are:

- Mobile agents have poor network performance, reliability and bandwidth, as well as poor flexibility to changes over contrasting methods.
- Lack of automatic agent redistribution and reconfiguration in case of network size change.
- Relative complexity of design and development compared to competing and existing mechanisms. The code has to work in variable environments, along with possibly other agents.
- Mobile agents are arduous to debug and test – they lack suitable development and programming abstractions found in other environments.
- Mobile agents are hard to authenticate and control when used in environments which require authentication or some form of access control.
- They are vulnerable targets to malicious environments, forgery and data theft. Identity thefts emerging via mobile agents can be laborious to defeat. Mobile agent's actions often resemble that of an Internet worm.
- No ubiquitous infrastructure, environment, nor language to interact with other agents. Optimising the agents to use the best available nodes for the job in hand, as well as the

overall network resources in the optimal way, is another issue.

3.8 Base station sleep mode

While being an effective method in increasing the wireless energy efficiency of the network, the BS sleep mode also has the negative potential to increase service delays and worsen the QoS for the customers. During the RBS sleep mode, the BS and its radio transmissions are switched off whenever possible, usually under low traffic load conditions. If for example the network's frequency carrier is not needed for the target QoS, it can be turned off in order to minimise the network wide energy consumption.

Sleep mode is important due to the fact that it enables the PA in the RBS – which is one of the biggest energy users in the RBS, to be shut down. Shutting down the PA also means that the PA's cooling equipment and signal processor can also be throttled down. The BS can shut itself down, or disable entire subframe transmissions to further reduce the power requirements if it has no, or very little amount of users (McLaughlin et al. 2011). Control signalling can account up to 30% of the total energy resources in the BS. The more subframes can be switched off, the fewer signalling bits are needed to be transmitted, and thus more energy will be saved due to the reduction of the redundant signalling.

BS sleep modes in future standards (Correia et al. 2010):

- Micro sleep modes

The BS suspends its transmission for the order of milliseconds. While in micro sleep mode the BSs are required to wake up almost immediately.

- Deep sleep modes

The BS transmitters are shut down for extended periods of time. While in deep sleep mode, some transmit circuits are completely switched off in the BS. This implies that wake up times are thus substantially longer.

To be fully able to utilise the potential of the BS sleep modes, compatible protocols need to

be developed that would allow suspending the reference symbol transmission at low loads. Also new protocols for handover and initial access procedures are needed that would enable the BS to be set in sleep mode.

The article (Niu et al. 2012) discussed the energy-delay tradeoff and sleep mode in BSs, and focused especially in the cases, where coordinated multi-point or cell zooming was not an option. The authors also proposed a novel queueing system for the BS, in which the BS holds a virtual queue for the sojourning clients. As the clients migrate away, or stop using the BS, the queue becomes empty, and the server begins waiting for the period of close-down time for any new customers. If new customers do indeed arrive during the closedown time, the server immediately resumes its service without any interruption. But when the closedown time expires and if no customers arrive into the BS, the server will be turned into sleep mode. During the sleep period, if enough customers arrive (into the queue), the server starts resuming its operation, and serves the new customers. There's even a patent concerning the energy efficiency of the BS entering sleep mode (Application number US 13/379,609 – Nylander, Rune, and Vikberg 2012, – US 20120106423 A1).

In another article (Elayoubi, Saker, and Chahed 2011), the authors talked about the same issue and coined the term *ping pong -effect* to describe the consecutive ON/OFF commands for the BS sleep mode (in which the resource is activated and deactivated several times consecutively, leading to a large signalling overhead), and because of this, the authors proposed (somewhat similarly to the previous work) a certain hysteresis period into the BS sleep mode decision process. The paper also talked about the practical implementation issues for wireless network sleep mode and presented algorithms to determine the optimal sleep mode that would minimise the energy consumption while preserving a desired QoS for the MTs.

Efforts to introduce sleep mode algorithms to help the energy efficiency of small cell BSs by astutely toggling their power in idle conditions, so as to modulate their energy consumption as needed, was discussed in (Imran, Boccardi, and Ho 2011). The article brought up three methods for algorithm control, relying on small cell driven, core network driven, and user equipment driven approaches.

Small cell BS's procedures in improving the energy efficiency may vary significantly based

on the BS's access control mechanism. For example, in sleep mode -schemes for closed mode small cells, the BS hardware might need to verify whether the subscriber requesting access to the resources really is a registered user for that network or not, before switching itself on. Depending on the small cell mode of operation, other criteria as well, such as MT's location information, MT classification, etc., are also integrated in the access (and waking up) decision algorithms (Imran, Boccardi, and Ho 2011).

By taking advantage of the presence of sufficient underlay macrocell coverage, the small cell hardware can be augmented with a *low-power sniffer* -capability that allows the detection of an active call attempt from the MT to the underlay macrocell. Using this procedure, the small cell can afford to disable its pilot transmissions, as well as the associated radio processing, to improve its energy efficiency when no active calls are being made by any of the MTs within its coverage area.

A small cell hardware can be thought to perpetually exist in either of the following modes (Imran, Boccardi, and Ho 2011):

- Ready state

In which all of the components of the small cell are fully operating and the pilot channel transmissions are broadcast in order to achieve a certain radio coverage area. All allowed users in the wireless coverage area are served by scheduling the radio resources on data channels. All traffic is served by the constraints set by the BS's maximum capacity.

or

- Sleep state

In which some or all of the small cell hardware is either completely switched off, or they operate in their corresponding low power modes. The components to be switched off depend on the specific hardware architecture, as well as on the energy saving algorithm used. The combination of algorithms with the hardware also depicts the time it takes to toggle between the Ready state and Sleep state.

If the MT located inside the sensing range of the small cell sniffer connects to the macrocell, the sniffer will immediately detect a strong rise in the received power on the uplink frequency band originating from the MT, due to the fact that the MT will try to transmit at a high power to the macrocell, while still being located very close to the small cell. Should the received wireless signal strength exceed a predetermined threshold, the detected MT can be deemed to be close enough to be potentially covered by the small cell, which at this point switches to its ready state and also activates its processing hardware, as well as its pilot signal transmission.

The active MT within the range of the small cell can then report the small cell pilot measurements to the macrocell, and if the MT is indeed allowed to access the small cell's resources, the MT's macrocell-to-small cell handover can be initiated, and if not, the small cell can resume its sleep mode again. If the handover process is successful, the small cell will try to serve the MT for as long as the call lasts, after which it can again resume its sleep mode – assuming if there are no more clients to serve.

Obviously however, this procedure implies the existence of macrocellular coverage, since it relies on detecting the MTs transmissions to the macrocell. This is also why the small cell has to check if adequate macrocell coverage is available. The coverage can be assessed using the macrocells pilot channel measurements at the location of the small cell, and by using the MTs own individual measurements. The sniffer-based sleep mode also requires one macrocell-small cell handover per connection. This is not so critical, due to the benefits gained from reduced mobility events, and also because the gains from reduced signalling are more significant than this.

As opposed to using a low-powered sniffer to steer the decision to wake-up and deploy a small cell into the macrocells coverage area, the wake-up signal could be sent via the core network's backhaul using a wake-up control message. In this method, a connection between the macrocell and the MT is set up after a paging message is transmitted to the MT in the downlink, or when an uplink connection request from the MT is made to the macrocell. Once the connection has been setup successfully, the macrocell who is serving the MT is being identified by the corresponding core network element (*e.g. mobility management entity in LTE*¹¹). The BS then verifies if there are any MT-associated small cells at the same macrocell

11. A network element that keeps the MT's context information.

region. The associated small cell to which the tagged MT is allowed to connect to is then sent a wake-up message via the backhaul link to initiate the transition to the Ready state and begin serving the MT.

There are certain advantages from the core network controlled solution over the small cell (sniffer) driven solution described before:

- The core network controlled mechanism makes distinction between registered and unregistered users, quite apart from the small cell driven solution. In the sniffer-based strategy, a small cell operating in the closed mode can unnecessarily switch itself on by detecting a noise rise from an unregistered wireless user in its vicinity. The problem becomes even worse if the BS is located in a busy area with lots of active users passing by.
- The core network driven approach enables the option to take a centralised decision, based not only on a particular MT but also taking into account the macrocell's overall traffic load, the user's subscription and traffic behaviour, type of service requested, and so on.
- The core network driven approach also enables the utilisation of the MT's location estimation (or even direct positioning), in order to further enhance the handover decision's effectiveness. For example, the MT can pass its location information to the core network, in both the idle and connected modes, in such way that the network can make a more informed decision on whether to activate or deactivate a nearby small cell. The MT could be configured to either update its location periodically, only when it changes, or only at the time of connection establishment.

A third strategy to control the BS sleep mode is to have the MT decide the wake-up and sleep cycles of the BSs in its vicinity according to its wake-up signals. When the small cell is in sleep mode it still maintains the capability to receive wake-up signals from the MT, and once such a signal is received, the small cell returns to its Ready-state. This solution is most practical when the MT is in its idle mode, whereas the small cell driven and core network controlled solutions demand the MT to be responsible for establishing the network

connection. The MTs wake-up broadcast can also have embedded identification information, so that the closed mode small cell gets only woken up by a legitimate registered MT.

This strategy can be implemented either by having the MT constantly transmit a wake-up signal, such that once the MT moves into the coverage area of a BS (to whose network it has been granted access to), the BS will immediately respond to it and wake-up. In a sense, the wireless coverage follows the MT as it moves around. This constant 'pinging' of wake-up signals from the MT however impairs its battery life.

Another similar approach is to have the MT without adequate wireless network connectivity broadcast the wake-up for the small cells signals only on demand, such as in the absence of sufficient macrocell coverage or in the need of higher data rate service. It is also possible for the MT to perform these wake-up broadcasts before establishing a connection with the wireless network. This enables the MT to wake up any nearby small cells first and then connect directly to the network through a chosen small cell. This on-demand approach can result in better energy efficiency since the small cells can be in Sleep-mode more often, and since they are only transitioned to the Ready state when required (Imran, Boccardi, and Ho 2011).

There are some advantages from the MT controlled solution over the small cell (sniffer) and core network driven solutions described above:

- This approach does not depend on the need for underlay macrocell coverage to switch the small cells on or off. This is specifically significant as many small cells could be deployed as a means of solving macrocells coverage black spots. Both small cell and core network driven solutions need enough macrocell coverage for the MT in order to enable sleep mode activation/deactivation.
- The amount of core network related signalling can be decreased. At any time the MT initiates a call, it does not have to initiate a connection with the macrocell underlay network, and only then get handed over to the small cell, after first waiting for it to transition from Sleep-state to Ready-state. According to the MT driven approaches described above, the small cell would already be in the Ready state at the time of

connection establishment, thus allowing the MT to initiate connection directly and immediately with it.

- This approach enables the enactment of a coverage follows the MT -principle, as mentioned before, without actually acquiring any specific MT positioning – hence saving the energy on the transmission of such data.

3.9 Cell wilting, cell blossoming and cell zooming

The size and capacity of a cell in wireless networks is typically fixed and determined at the stage of network planning based on the estimated traffic load in the area. The traffic load can nevertheless have substantial spatial and temporal fluctuations, which can both bring challenges and new possibilities to the planning and operating of the wireless networks. For a cellular network in a city, and especially in its office districts, the traffic load in the daytime is relatively heavy, and meanwhile light in residential areas. The situation reverses in the evening, as the labour force eventually returns back home.

Should the network capacity be planned static based on the peak estimated load for each cell, there would always be some cells under light load, and other cells under heavy load (and even worse, some cells might be at their capacity limit). The situation would be suboptimal due to the inevitable fluctuation in wireless traffic.

This nature of fluctuation is essential knowledge when designing the network's cells. *Dynamic network planning*, such as cell zooming can either be exploited for load balancing by transferring traffic from heavily loaded cells to the cells under a light load, or for energy savings optimisation.

Cell wilting and blossoming refers to the case when a cell's coverage area (*e.g. the radius, cone or beam*) is being increased or decreased by modulating the RBS's RF-power, or by tilting the antennas based on the current mobile traffic needs. More specifically, cell wilting refers to the case when the cell is gradually being entered into its sleep mode (*i.e. its coverage area radius zooms in to zero*), whereas cell blossoming refers to the case when the cell exits from this sleep mode.

Cell wilting and blossoming is an alternative method to modify the cell's coverage area, especially when only a few users are being served, or when the nearby cells are not operating, perhaps due to their own ongoing sleep mode. Forcing users to use another cell would in this case mean switching the nearby cell on, which in turn would mean comparably more power used. This technique can also save power due to the possibility to decrease the RF-power in the case all users are very near to the BS. Cell size decreasing also results in less interference between the neighbouring cells, and thus more power is saved due to the fact that the cells don't have to combat their neighbouring cell's wireless interference.

The heterogeneous networks are currently typically over-dimensioned (*i.e. when there is only little traffic, the probability of having unused BSs increases considerably, especially if the cell is small*). Sleep modes enable switching off the unused BSs when and where they are not necessary, as discussed earlier in section 3.8.

The BS sleep mode must be designed in a such way to satisfy the three requirements for sufficient operation (Conte et al. 2011):

- Minimise the network wide consumed energy.
- Guarantee the availability of wireless services over the network area.
- Minimise the experienced degradation of the user experience.

These requirements also define the sleep mode mechanism in general – they specify when, how and which of the BSs take part in cell wilting and blossoming. A simple trigger for starting the sleep mode could be by monitoring the BS activity in order to detect whether the BS is underutilised or even unused. The most trivial case is if the cell is empty for a certain period of time. The odds for this situation increase as the cell size shrinks. The article (Conte et al. 2011) also brought up a case study of cell wilting and blossoming from the city of Munich, Germany, as well as a bit more theoretical scenario with computations for the BS sleep and wake-up transients, power profiles and interference areas.

The figure 13 on page 67 illustrates a set of cells without any type of cell zooming collaboration. The BSs are located at the respective centres of the cells, denoted by hollow circles,

- Base station
- Mobile terminal

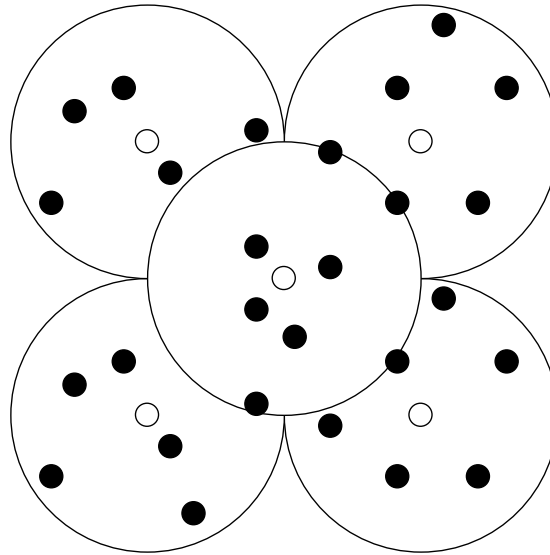

Figure 13. Illustration of a network of cells.

and the MTs are marked as black circles and placed randomly in the cells. In the figure 14 on page 68, the image A illustrates the *energy savings* -case, where the cell in the middle has entered its sleep mode, perhaps due to very low traffic, and the other nearby cells must thus take over the MTs in its range by zooming out. In this example only two cells zoomed out. Zooming out in this scenario also minimises the possibility to create service coverage gaps in the network. Image B on the right represents an alternative case, in which the central cell has once again entered its sleep mode, and the other cells are co-operating in order to transmit to the MTs in the sleeping cell's coverage area in lieu of the sleeping cell.

In the figure 15 on page 69 the network is attempting to *load balance* the traffic. The image on the left demonstrates the situation in which the network is heavily loaded as some of the MTs have moved into the central cell's coverage area and made it congested. The central cell must therefore zoom in, in order to reduce the cell size and to be able to serve all of the MTs in its range. On the other hand, the image B on the right represents the opposite situation where the traffic conditions in the central cell are becoming lighter due to the MTs migrating outside of it. The cell in the centre is matching the availing wireless traffic needs by zooming

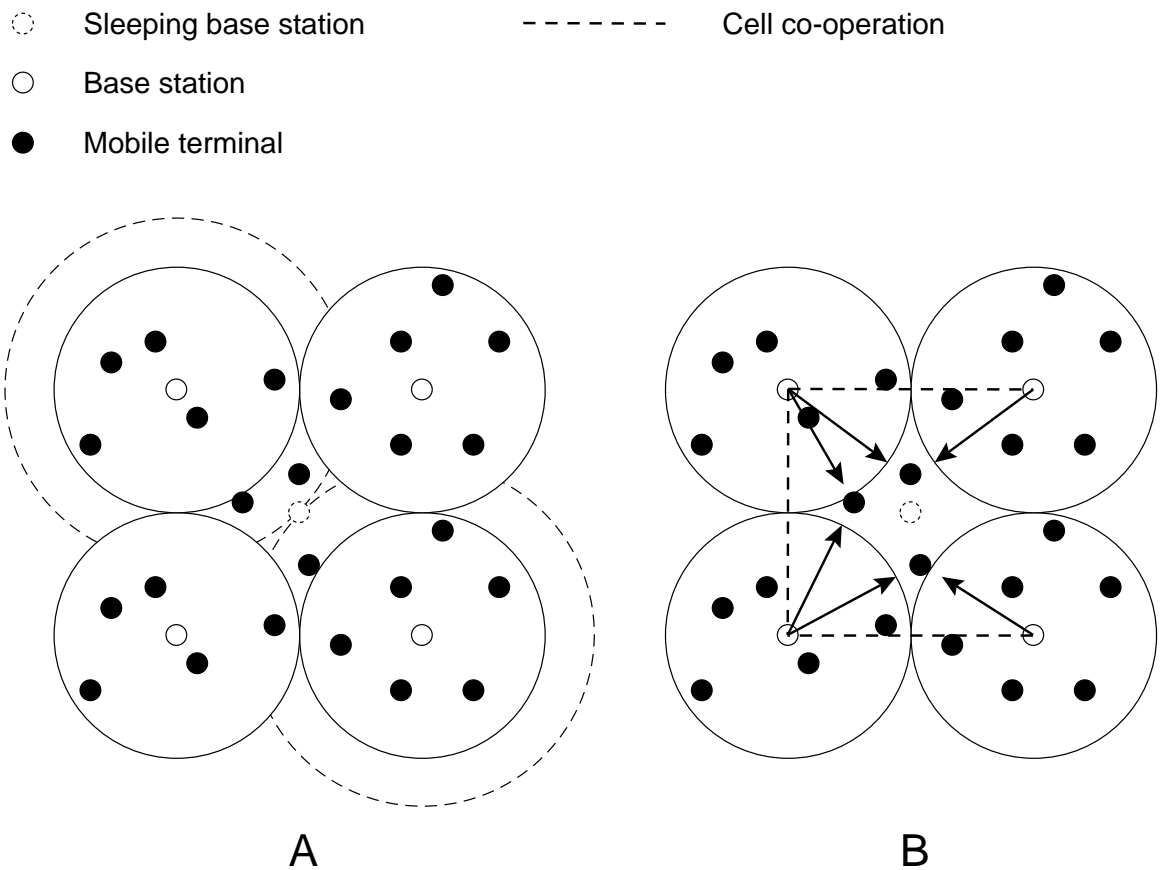

Figure 14. Illustration of cell zooming for energy savings gains.

out to help the other neighbouring cells, and thus keeping them from getting congested.

By gradually decreasing the BS transmit power (*wilting*), the impact of the reduction on dropped calls can be minimised. It is possible however for the MT to order the wilting process to be stopped, or even reverted (*i.e. switch back to blossoming*) entirely in case the MT is experiencing too poor of a service quality, and having no possibility to migrate (*handover*)¹² to another BS. The same reason is good enough at all times to engage the sleep mode exit process (*blossoming*), which also happens gradually in order to allow the MTs to handover to the BS that has the best measurable service quality from their standpoint. Cell blossoming is also triggered when it becomes obvious that the BS's neighbouring cells can

¹². Handover refers to the situation in which all of the radio resources of a connection are handed over to another BS. Handover can be triggered by a predetermined handover function based on either power level or service quality measurements.

- Base station
- Mobile terminal

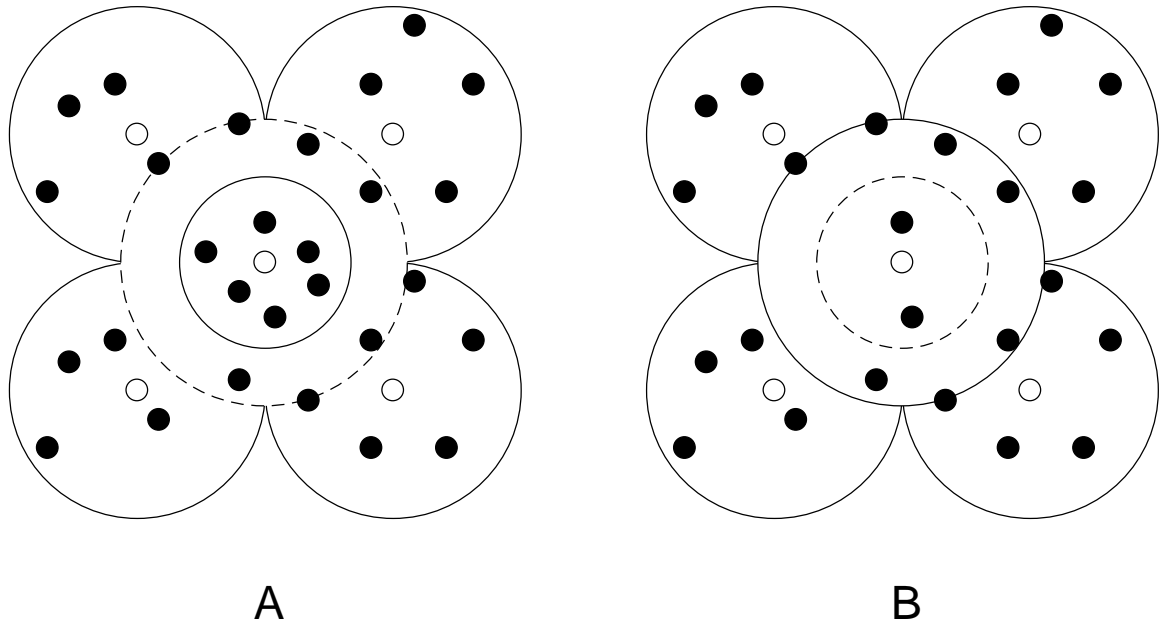

Figure 15. Illustration of cell zooming for load balancing.

no longer handle all of their own traffic and are thus becoming seemingly overloaded. When this happens, the overloaded cell uses the operator's core network link to signal the other neighbouring cells to wake up (blossom) and serve some of the users on their behalf.

Cell zooming is implemented by using a number of network components. A cell zooming server, which is a virtual element implemented either in the gateway or distributed in the BSs, controls the procedure of cell zooming. The cell zooming server first senses the network state information for cell zooming, such as traffic load, channel conditions, user requirements, and so on. The sensing process can be realised by specific control messages. After collecting the information, the cell zooming server tries to analyse the opportunities for cell zooming. If a cell needs to zoom in or out, it coordinates this process with its neighbouring cells and with the help of the cell zooming server. These cells will then either try to zoom in or out by physical adjustment, BS cooperation or relaying (Niu et al. 2010).

There are a number of techniques that can be used to implement cell zooming:

- Physical Adjustment

Adjusting the physical parameters in network deployment can help in cell zooming. Cells can zoom out by increasing the BS's transmit power, and vice versa zoom in by decreasing the said power. In addition to that, the BS's antenna height and tilt can also be modified for the cells to be able to zoom in or out.

- BS Cooperation

BS cooperation simply means that multiple BSs can together form a cluster, and cooperatively transmit to or receive from the MTs in it. This is also known as *Coordinated Multi-Point (CoMP)* transmit/receive in 3GPP LTE-Advanced (3GPP 2013a). The newly formed cluster is an entirely new cell from the MT's perspective. The size of the cooperated cell is the sum of the original sizes of the BSs in cooperation. The size can however be even larger, as BS cooperation can reduce the inter-cell interference.

- Relaying

Relay stations are deployed in cellular networks in order to improve the performance of the cell-edge MTs. Relay stations can also be deployed near the boundary of two neighbouring cells, in which case, the relay station can relay the traffic from the heavily loaded cell to the cell under light load. The heavily loaded cell zooms in, and the underused cell in turn zooms out.

- BS Sleeping

When a BS is in its sleep mode, the air-conditioner and other energy consuming equipment can be switched off. In the case the cell is in sleep, the neighbouring cells will try to zoom out to cover for its absence.

Cell zooming has the capability to both spread the wireless traffic for load balancing scenarios, and concentrate the load for energy saving -purposes, and in both scenarios also help the wireless traffic to function as fluently as possible. BS cooperation and relaying can re-

duce the inter-cell interference, mitigate the impact of shadowing and multi-path fading, and reduce the handover frequency thus improving the energy efficiency of the network.

In order to make cell zooming as efficient and flexible as possible, it is imperative that the wireless traffic load fluctuations are to be exactly traced and fed back to the cell zooming server for it to be able to respond to the availing conditions as necessary. This can however be challenging, as the traffic load has significant spatial and temporal fluctuations. Not all of the cell zooming techniques are supported by current cellular networks. The additional mechanical equipment to adjust the antenna height and tilt, BS cooperation and relaying techniques reflect some of the unresolved compatibility issues. In addition to the physical changes, also changes in the current state of network management are required (*i.e. network information feedback via control channels*) (Niu et al. 2010).

A predefined BS sleeping scheme according to a deterministic traffic variation pattern over time was presented in (Marsan et al. 2009). Similarly, switching off certain microcells without compromising from a predetermined blocking probability was discussed in (Chiaraviglio et al. 2008). In both of these papers, the sleeping pattern is nonvolatile, and the traffic intensity is expected to be distributed uniformly over the entire network. There are several other cell ON/OFF switching systems and approaches proposed in both academic papers, as well as in the industry – overview to LTE energy saving solutions to cell switch ON/OFF in (3GPP 2010b), LTE energy saving solution proposal in (3GPP 2009b), LTE energy saving solution proposal to cell switch ON/OFF in (3GPP 2010a) and (3GPP 2009a) and dynamic BS energy saving in (Zhou et al. 2009). Also in the previously mentioned article (Niu et al. 2010), cell zooming algorithms in cellular networks with fluctuating spatial and temporal traffic load was presented.

The article (Weng, Cao, and Niu 2011) considers energy saving at the cellular network planning stage. The article proposes an evaluation method to assess whether or not to adjust deployment obtained from traditional planning in order to switch off more cells, which in turn normally requires the remaining active cells to extend their coverage to a certain extent. This requirement could be achieved with cell zooming (by altering the transmit power).

Cell zooming has the potential to cause problems as well, such as inter-cell interference,

or coverage holes for instance in the case when the maximum allowed transmission power of the remaining active BSs is not sufficient to achieve full wireless coverage for the shut down cells. As a result of this, some service disruption can be expected in these areas. In addition to this, the increase in transmission power might also result in intercell interference if more than one active BS tries to achieve radio coverage for the area of the switched off cells. As a result of this, additional interference management solutions are needed. Also if two or more neighbouring cells zoom out simultaneously, this will obviously generate more inter-cell interference amongst them. If in this case BS cooperation is not a possibility for some reason, additional interference management systems are required in order to reduce the produced interference.

Two solutions are brought up in the literature to avoid the shortcomings of the aforementioned dynamic planning:

- The first one relies on the mobility of the relay nodes to help migrate the traffic away from the shut down BSs to the active ones (Kolios, Friderikos, and Papadaki 2010). This solution is not however reliable in the case of delay-sensitive applications, such as voice telephony.
- The second option uses the cooperation between two competing cellular operators to achieve energy savings by allowing wireless traffic to be carried on from one operator's shut down BSs into the other operator's active BSs (technique also known as *roaming*) (Marsan and Meo 2010). The other operator is essentially turning into a virtual operator, who offers their service through the host operator's leased infrastructure.

3.10 Multiple antenna systems

Single-Input, Single-Output -systems (SISO) have been popular due to their simplicity, ease of use and low cost long before there was any serious talk about energy efficiency or performance improvements of the wireless systems. In SISO-systems, there is only one antenna at each end of the wireless link. This method is often inferior to Multiple Input, Multiple Output -antenna systems (MIMO) in energy efficiency and in performance, but still superior in its ease of deployment, cost and usage. MIMO-systems increase the wireless capacity

through *diversity* by adding more antennas into the antenna array, and also through the signal strength gains from the antenna array.

Additionally, MIMO has also the potential to increase the energy efficiency of the wireless system due to the capability to transmit the transmissions faster. Faster transmissions can in turn result in reduced time for the transmitter being on. Less time the radio and its transmitter needs to be active can also translate to having more time for the wireless spectrum being available for other traffic – and also less power used in the transmission.

Antenna diversity is an important technique in alleviating multipath propagation situations, and improving the quality and reliability of a wireless link. It is advantageous in situations where there is no clear LOS link between the transmitter and the receiver, and consequently the transmitted signal gets reflected along multiple different paths before finally arriving at the receiver. Each of the reflections can introduce phase shifts, time delays, attenuation, and distortions into the signal. All of these phenomena can destructively interfere with the signal at the aperture of the receiving antenna.

Multiple antennas can in a sense offer the receiver several observations, or references of the same received signal – this can be beneficial when determining what exactly was sent, especially in poor radio conditions. Every receiving antenna receives the transmitted signal slightly differently, but due to the antenna diversity, the whole transmitted message can be estimated (or approximated) correctly. This method also introduces some robustness into the communications link, due to the lessening of the impact from one receiving antenna's failure in receiving the signal correctly (or at all for that matter).

Diversity exploits the knowledge, that independent wireless signal paths have a low probability to all experience deep fading channel conditions simultaneously. Diversity techniques that can mitigate the multipath fading effects are known as *microdiversity*, whereas the diversity techniques that focus on mitigating the shadowing effects caused by buildings, or static objects are known as *macrodiversity* (Goldsmith 2005). Macrodiversity is normally realised by coordinating and combining the received signals from several BSs or APs, whereas microdiversity can be effectuated by using multiple antennas, or by using differing polarisation in the antennas. In MIMO-systems, both the transmitter, as well as the receiver can be used

for diversity gain.

Energy reduction in multiple-antenna transmitters is also possible by disabling a certain number of antennas, as this reduces the required reference signals in the reduced spatial channels. With a smaller control overhead size, the RF energy used for control signalling will potentially decrease. Meanwhile, the operational energy used by each antenna's PA will be reduced significantly if a separate amplifier is used in each radio antenna (McLaughlin et al. 2011).

Reducing the control overhead also means reducing the RF-power needed to run the control signals. Using a separate amplifier for each antenna reduces the operational energy used by the antennas. The improvement of energy efficiency in MIMO transmissions is also possible due to the fact that single-antenna transmissions consume less energy for control signalling, but the increased spectral efficiency of MIMO makes it still more overall energy-efficient for a fixed amount of user data transmissions (Laselva et al. 2009). Careful decision regarding of which MIMO-model to use under a certain situation has the potential to impact the RF-power usage by a great deal. Figure 16 on page 75 illustrates a simplistic model of a MIMO-system, in which two nodes, node A and node B both have four radio interfaces, two for receiving and two for transmitting.

Systems equipped with MIMO antennas, combined with adaptive transmission techniques that exploit the transmitter channel knowledge, offer improvements in spectral efficiency. However, accurate information of the actual wireless channel conditions for both the transmitter and for the receiver is essential. This information is carried in the form of reference symbols, or *pilots*, which are known to the receiver. The amounts of these pilots builds up intensely along with the number of transmit antennas. As the number of the BS antennas grows, the system gets almost entirely limited from the reuse of pilots in the neighbouring cells, the situation is known as *pilot contamination concept* (Rusek et al. 2013). This pilot contamination is a fundamental challenge of very large MIMO system design.

At full load, the energy consumed to transmit this overhead is overcompensated by the spectral efficiency improvements, and up to 50% of reference signal overhead is still a reasonable handicap in order to get the capacity gains from added transmit and receive antennas at a fixed

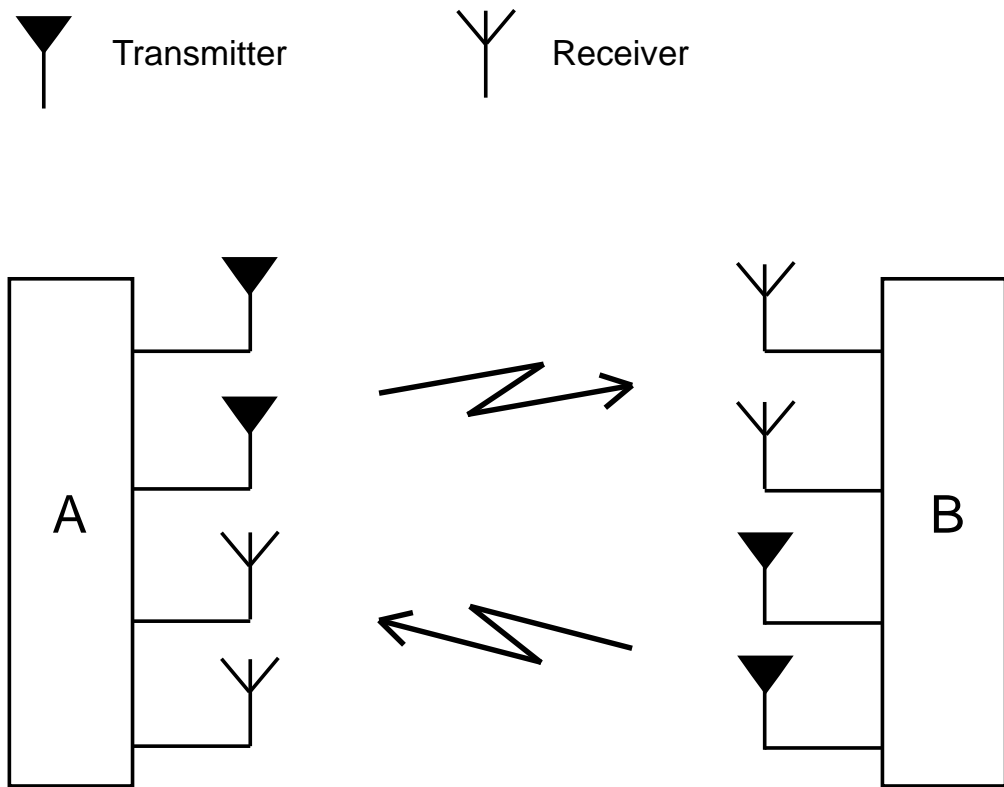

Figure 16. Illustration of a simple MIMO-system.

total power (Hassibi and Hochwald 2003). On the other hand, this auxiliary information remains the same in low load situation as well. Accounting the system information, control and synchronisation channels, the overhead may exceed 25% of its maximum even if no data is being transmitted.

This unnecessary predefined control signal transmission accounts greatly to the power consumption of a network in general. With the increasing trend of current smartphones containing MIMO-capable LTE technology, the overhead in low load situations becomes even more increasingly bigger issue for the energy efficiency (Correia et al. 2010). The authors in (Intarapanich et al. 2004) investigated the capacity of multi-element antenna systems in microcell and picocell environments. The authors devised a *Geometrically Based Single Bounce Elliptical Model (GBSBEM)*, with which they determined the antenna's spatial correlation in uniform broadside linear array and in uniform circular array. Increased capacity has the benefit to carry more MTs for the same amount of resources, thus increasing the energy efficiency of the system.

In an article by (Sulonen et al. 2003) the authors compared and discussed the usage of MIMO-antenna configurations in small cell systems (notably picocell and microcell). The authors noted, that increasing the element distance also increased the capacity and diversity of the system, especially in urban environments. Interestingly, the authors also showed, that the number of elements of the fixed station antenna is not as significant outdoors as it is in indoors configurations. In indoors, the environment is more prone to introducing signal scattering, which helps the utilisation of the signals more efficaciously by adding more antenna elements and thus receiving the wireless signal in parallel.

In (Kermoal et al. 2000), the authors experimentally investigated the performance of a multi-element antenna array, and showed that eigenanalysis is a useful tool in describing the effective number of parallel channels in a multi-element array configuration. In an article (Martin, Winters, and Sollenberger 2000), and again a year later in (Martin, Winters, and Sollenberger 2001), the authors showed that in a 30 kHz channel with dual-polarised, spatially-separated BS and with terminal antennas with a configuration of 4 transmit and 4 receive antennas, close to 4 times the capacity of a single antenna system can be achieved. The article (Kermoal et al. 2001) brought up the concept of using either omnidirectional or directive antenna elements in MIMO antenna systems. In the article the use of polarisation diversity was considered as a solution to obtain more compact antenna array layout by providing another diversity dimension to the MIMO radio channel.

3.11 Relays

Relays are an effective alternative to using multiple antenna systems to enhance the energy efficiency of wireless networks. Relays simply forward information between a user who is at the cell edge (and thus at a poor signal coverage area), and the RBS. Relay's purpose is to extend the cell's coverage area, and to improve the wireless network performance where needed, without unnecessarily increasing the macrocells RF-power. By carefully choosing the placement for the relays, they are not only going to be beneficial for macrocells, but they also decrease the transmission power of the MTs, drastically resulting in a longer battery life. The quality of the wireless channels is also enhanced with the help of the relays capability of overcoming any of the obstacles between the MTs and the BSs, which might otherwise

hinder the channel quality. The benefits of using relays match many of the issues concerning the today's energy efficiency improvements.

The relaying methodologies can be distinguished from each other and further broken down into following strategies:

- Amplify-and-forward

In amplify-and-forward strategy, the relaying station only amplifies the received signal from the source node and forwards it to the destination station.

- Decode-and-forward

In decode-and-forward strategy, the relays overhear transmissions from the source, decode them, and in case of correct decoding, also forward them to their destination station. Should any unrecoverable errors materialise in the overheard transmission, the relay is unable to continue the cooperative transmission.

- Compress-and-forward

In the compress-and-forward strategy, the relay station compresses the received signal from the source node and forwards it to the destination without actually decoding the signal first.

In the ideal case, relays are only operating when there are users using them – meaning that relays don't waste power for instance by unnecessarily broadcasting their existence if there are no known users in their coverage area (Bahr 2006). With relays, the radio's transmission power can be minimised due to the decreased distances between the transmitter-receiver pairs. The transmission power savings depend chiefly on how the relays are placed. Three different methods (algorithms) to optimise the relay's placement and sleep patterns in order to attempt to minimise the transmission- and circuit power consumption are formulated in (Zhou, Goldsmith, and Niu 2011).

Figure 17 on page 78 illustrates a simplistic principle of wireless relaying, in which the MT is at such a range from the BS where the communications would have to be transmitted using

high power only. A wireless relay that has a clear radio link to both the MT and the BS is then deployed in the range of both the MT and the BS, in order to provide satisfactory cellular network coverage for the MT with less transmission power for the both parties (items in figure are not in scale).

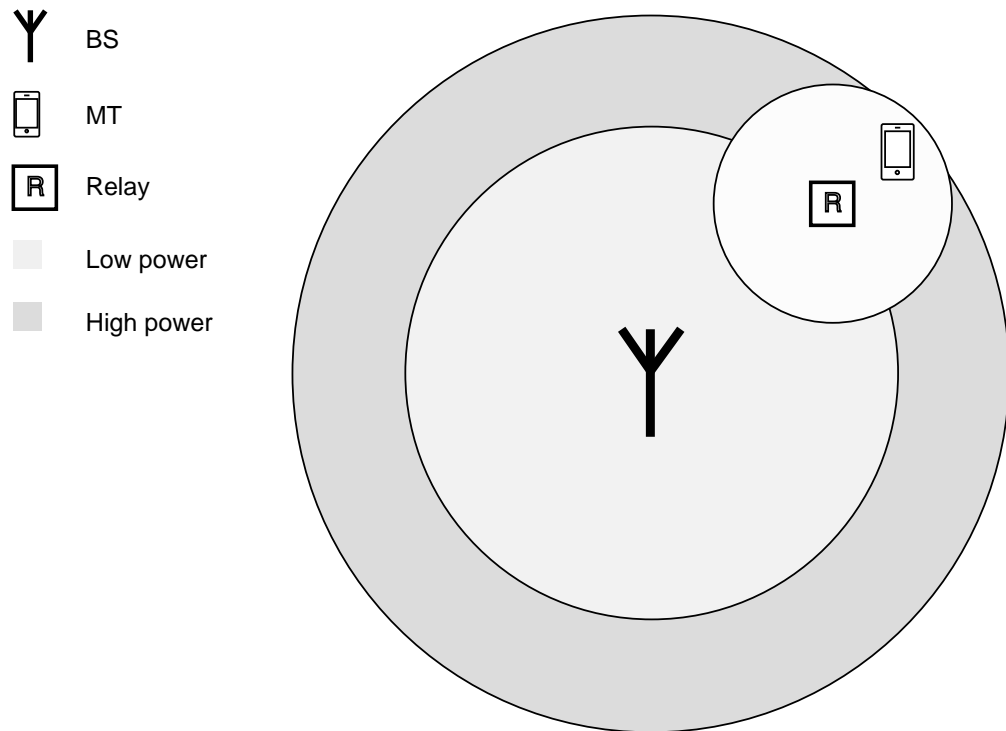

Figure 17. A simplistic example of wireless relaying.

There exist several analogous methods and algorithms for maximising the wireless network capacity in (Lin et al. 2010), and to minimising the average error probability by the authors in (Cannons, Milstein, and Zeger 2009, whose work is actually equally related to wireless sensor networks in general). Also some closely related work has been done in the article (Cheng, Chuah, and Liu 2004) regarding the energy efficiency of wireless sensor node placement. The article (Hou et al. 2005, again equally related to wireless sensor networks) discusses the joint relay placement issue, as well as the initial energy allocation problem in order to maximise the sensor network lifetime. Because of the conveniences of lower complexity and lower installation and maintenance cost of a relay compared to a BS, the development and deployment of relays has drawn substantial attention from both industry and academia (*e.g.*

*IEEE 802.16j*¹³ (IEEE 2009)).

Concerning the MTs, dual APs association is a technique, where the MT uses a relay station in a IEEE 802.16m network for the uplink connection to the BS (Ahmadi 2011). Considerable, up to 7 dB transmitter power reductions can be achieved by using this method (Kim, Yang, and Venkatachalam 2011). Advanced terminals capable in using dual AP association can operate on multiple RATs – GSM, 3G, Wi-Fi, and possibly more in the future (Auer et al. 2010). A problem with the current RAT approach is that each RAT is being operated as an individual, making it hard for the multi-RAT terminals to take advantage of them due to the incompatible management methodologies.

Modern developments in physical layer cooperative relaying technology, such as Decode-and-Forward (Xie and Kumar 2007) and (Cannons, Milstein, and Zeger 2009), can improve the wireless data rate even more by exploiting the spatial diversity in the physical layer. The capacity improvement gained from cooperative relaying is due to the exploitation of all of the received signals that were initially taken as noise and interference. Relays can also be formed as a wireless mesh network.

3.12 Wireless mesh networks

A wireless mesh network (WMN) can be described as a special type of wireless ad-hoc¹⁴ network. An ad-hoc network¹⁵ is a decentralised wireless network, in which the nodes route and forward data to the other nodes. All devices in an ad-hoc network have equal status, and they are all free to associate with any other ad-hoc network device in their range. Ad-hoc network devices are capable of maintaining information for other devices in 1 hop range. Ad-hoc networks can be formed from whatever devices happen to be currently available, without actually incurring the cost, installation or maintenance of new network infrastructure. They can also be easily and quickly redeployed and reconfigured, and their distributed nature provides them with inherent robustness and redundancy against a single neighbouring failing

13. IEEE Standard for Local and metropolitan area networks Part 16: Air Interface for Broadband Wireless Access Systems Amendment 1: Multiple Relay Specification.

14. *For this purpose* in Latin.

15. Even the 802.11 (*colloq. Wi-Fi*) standard includes ad hoc networking capabilities.

node.

WMNs consist of wireless mesh routers and wireless mesh clients, and their purpose is to provide a more flexible, reliable and better performing network, compared to a traditional centralised and managed (infrastructure) wireless network. The core asset of an ad-hoc network, the lack of infrastructure, is also the key characteristic from which most of the design challenges and principles stem from.

The main idea of WMNs is that the communication between the WMN clients and the external network (*e.g. the Internet*) hops through multiple WMN nodes on a meshed network topology (Ahmadi 2011). The mesh routers typically have only minimal mobility, and thus they form the backbone of WMNs. Mesh routers are also responsible for providing network access for the mesh clients. The WMN routing protocol ensures that the packets are being provided paths through the network's intermediate nodes to their destination, even if parts of the network were to change, or even if some of the WMN nodes would become unreachable (*e.g. poor radio connection, low energy reserves, etc.*). The chosen routing protocol should be able to always route the packets using the fastest possible route.

WMNs can be formed by using one or more various wireless technologies in its network nodes, for example IEEE 802.11¹⁶, IEEE 802.15¹⁷, IEEE 802.16¹⁸, or some type of a cellular connection. Because of the multitude of the available connectivity options, the wireless mesh routers are typically equipped with several wireless interfaces of either the same or different wireless access technologies. The wireless mesh routers have a higher energy efficiency compared to conventional wireless routers in multi-hop communications, because much less transmission power is needed in WMNs for the same service coverage area.

A core feature of WMNs is that all of the wireless mesh clients have the necessary functions for mesh networking, and can thus also work as routers if necessary. Any gateway or bridge functions do not however exist in these nodes. As a consequence of this, the hardware and software platform in wireless mesh clients is far simpler compared to wireless mesh routers. Mesh clients also typically only have one wireless interface (Akyildiz, Wang, and Wang

16. A set of standards for implementing a WLAN.

17. A set of standards for implementing a WPAN.

18. A set of standards for implementing WiMAX.

2005).

Figure 18 on page 81 illustrates a simplistic model called a *mesh cloud* of a typical tiered WMN structure for serving Internet access for the wireless mesh clients. In the figure, the first level after the Internet consists of the APs (*or gateways*) for accessing the Internet, as well as serving the next level routers. The second level consists of the networked wireless mesh routers, which themselves form a backbone for the third tier wireless mesh clients. The mobile mesh clients (end-users), who are in the range of a wireless mesh router, use the routers for accessing the Internet, whereas the mesh clients not in range of a mesh router, will try to use another mesh client as a route to the Internet (Zhu, Fang, and Wang 2010). As an example of the robustness of a WMN, should the links in the figure between routers 3 and 5 fail, the WMN cloud could still try to route the necessary traffic between them via a different route, in this case through router 4.

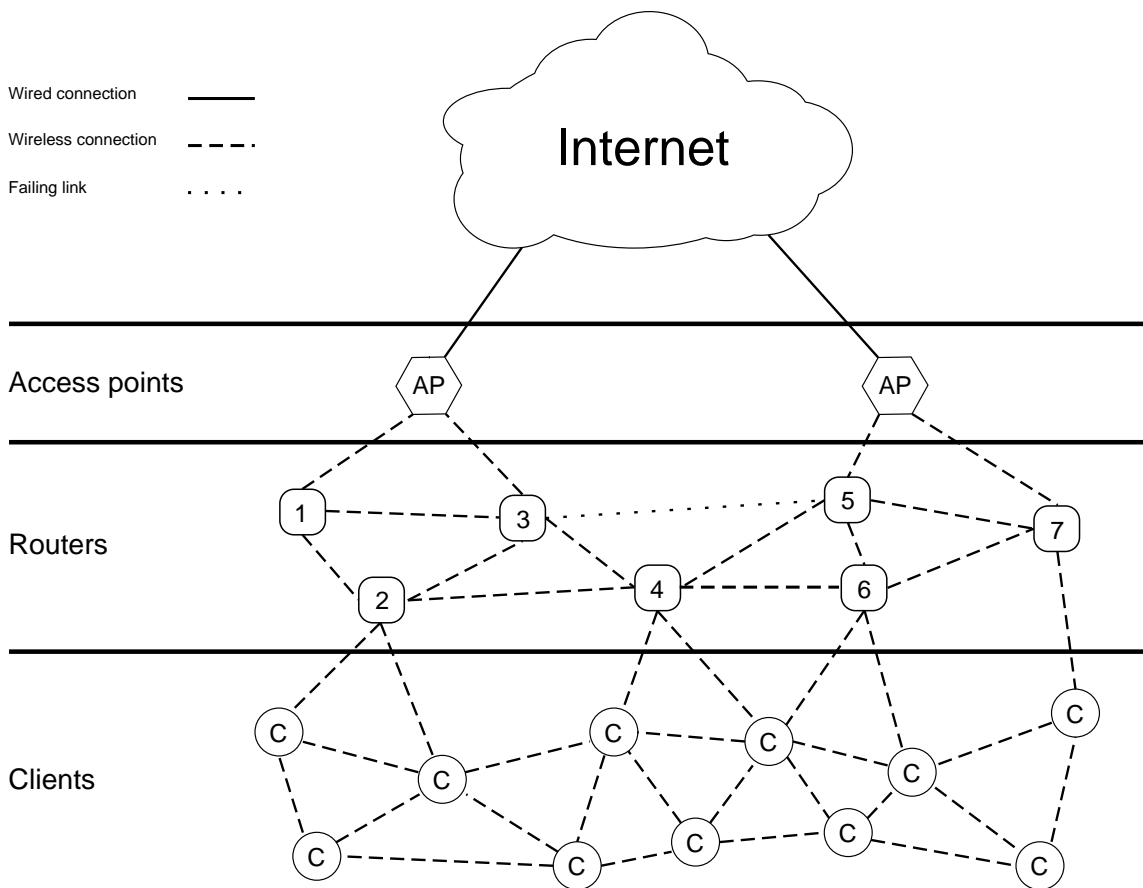

Figure 18. Overview of Wireless Mesh Network -topology.

There are proposals to create WMNs that would only use renewable energy sources, such as solar power or wind energy to form so called *green WMNs*. The main motivator for these green WMNs is to be able to create low maintenance APs, which are not dependent on any source of fossil fuels. Green as a technology is described in more detail at section 3.2 on page 21. Renewable energy source is also a viable option in the case where the WMN nodes might be placed in hard to get, dangerous or hostile areas (*e.g. military reconnaissance sensors, unmanned aerial vehicles or remote weather sensors*). The major downside for this concept is the inherent unreliability of the renewable energy source – the energy source (nor the rechargeable batteries within the WMN) must not deplete under any circumstances while in use, or the connection to the node is lost.

Communication protocols suffer from scalability issues in multi-hop networking. As the size of the network increases, the network performance degrades notably – this has a direct impact on the energy efficiency as well. There are issues in IEEE 802.11's synchronisation mechanism (Huang and Lai 2002), and in workload throughput performance (Jain et al. 2005) as well. Routing protocols are not flawless in finding a reliable routing path, not to mention transport protocols, which might sometimes lose connections as well. Problems can surface also from too high inter-link distance, poor SNR, or multi-path fading due to the reflections in the wireless environment (Aguayo et al. 2004). Even the careful selection of the used routing metric can influence the performance of a WMN to a great deal as shown by the authors of (Draves, Padhye, and Zill 2004).

Also, despite the fact that many security schemes for WLANs have already been proposed (*e.g. WEP, WPA, WPA2*), none of them are directly applicable, mature and ready to be used in WMNs without some modification. The distributed nature of a WMN-system makes it hard to provide a replacement for a centralised public key distributor for secure networking. As a consequence of this, more advanced security schemes (such as encryption algorithms, and new ways for public key distribution), high performance MAC- and routing protocols, a reliable intrusion detection and prevention system, as well as security monitoring subsystem must be developed.

The *Hybrid Wireless Mesh Protocol* (HWMP) is the de facto standard for mesh routing protocol for a WMN, which combines the flexibility of on-demand routing with proactive topology

tree extensions. HWMP uses a common set of protocol primitives, generation and processing rules taken from *Ad Hoc On Demand* (AODV) routing protocol (IETF 2013). AODV forms the basis for finding on-demand routes within a mesh network while additional primitives are used to proactively set up a distance-vector tree rooted at a single root mesh protocol (IEEE 2013).

WMNs may actually contain either fixed or wireless devices, which is why the applications are as diverse as are the communication needs, for example:

- Home networking

Typically wireless home networking is implemented by using IEEE 802.11 WLANs, but they have frequently issues with range, AP location (and hence dead zones) and above all increasingly often problems with band congestion, especially in big cities. The wireless mesh routers alleviate these issues by having the capability to route the traffic via several nodes to the areas where the Wi-Fi signal would not otherwise necessarily penetrate, while possibly switching to an unused band to increase data transmission performance.

- Enterprise networking

Companies with separate office branches would normally connect the offices via Internet on a dedicated line. Sharing documents on the Intranet between the offices would imply using the often-congested shared Internet line. Such transfers would benefit from offloading the traffic to a network such as the WMN. This model could be applied to many other public and commercial service scenarios as well, such as airports, hospitals, hotels, shopping malls, convention centres, sport centres, security surveillance systems, etc.

- Metropolitan area networks

The data transmission rate of a WMN can achieve much higher speeds than what is possible in most cellular networks in dense urban areas. Theoretically, an IEEE 802.11g based WMN node can transmit data at a rate of 54 Mbps (although in real life the speed remains less than half of this), whereas most achievable cellular data connec-

tions lag far behind. On the other hand, IEEE 802.11ad "*WiGig*" (IEEE-P802.11-TGad 2013), once released, will offer multi-gigabit wireless transmission speeds (Perahia et al. 2010). WMNs can also be more economic to use compared to a mobile broadband plan offered by a typical telco – and not to forget there are also no transfer caps in WMNs.

- Transportation systems

A WMN can extend wireless networking access into trains, buses or ferries with the help of a mobile broadband hub.

- Building automation

Various electrical devices including energy or power meters, light control, elevator status, or air conditioning, can be controlled and monitored via a WMN.

- Spontaneous networking

By simply placing WMN routers in desired locations, a WMN can be quickly established for spontaneous events for example in outdoor parties, festivals, or for an emergency response team for on-site shared communications link.

The self-organisation capability, as well as the option to utilise multiple wireless network technologies in WMNs, helps reducing the network deployment and maintenance phase complexity, as well as directly reducing the upfront investment costs compared to more traditional networks. It also provides the WMN clients a flexible access to the Internet anywhere and anytime. The majority of the current WMN deployments are based on the IEEE 802.11 standard, due to the low cost and easy availability of the hardware. Experience gained with IEEE 802.11 helps raise other wireless transmission standards, like WiMAX and 3G/4G, into viable options as well (Pathak and Dutta 2011).

3.13 Network co-operation between different available networks

The demand for different mobile offloading solutions springs from the explosion of wireless Internet data traffic, namely the growing portion of traffic going through mobile networks. This surge has been enabled by smartphones and laptops with mobile broadband access capabilities, with rich variety of data hungry applications created for them on the Internet. During the last few years an explosion in the existence and use of wireless devices that are both cellular and Wi-Fi enabled has also been observed. Short Internet browsing sessions (*e.g. accessing a single web page*) typically do not require handover, nor would they benefit much from it, but longer duration sessions, such as VoIP, audio/video streaming and large downloads, typically have such QoS requirements, that a handover would be beneficial.

Network co-operation between different available networks (such as WLAN or UMTS) exist to help the MTs in keeping a constant network access when necessary, be it Internet, DVB or UMTS for example. The way this can be beneficial in energy savings perspective, is that the MT doesn't always have to use a single specific radio interface for its network access. If there are alternatives for example to using the UMTS network, whose Node B might be congested or further away than an alternative network (in which case the transceiver's RF power would be higher, and thus it would then have a negative impact on the battery life), the MT might make the decision to switch to the optional network to evade the negative qualities. From the subscriber's point of view, the alternative AP might also provide faster access at a cheaper rate, like for example the free public Wi-Fi compared to UMTS, whereas for the operators, the motivator for network co-operation and traffic offloading might be the option to ease the congestion of their cellular networks (Aghvami et al. 2006).

Wi-Fi, WiMAX and regular wired networks (LANs) are the primary offloading solutions used by the industry. Wi-Fi offloading appears to be the most viable solution to implement at the moment due to the fact that many users are installing their own Wi-Fi APs at their homes. Building more Wi-Fi hotspots is also significantly cheaper than network upgrades. Authors of the article (Sommers and Barford 2012) compared cellular and Wi-Fi performance together using crowd-sourced data, and found that Wi-Fi offers better absolute download/upload throughput, as well as a higher degree of consistency in performance. The authors also noted, that Wi-Fi networks can generally deliver lower absolute latency, but the

consistency in latency is often better with cellular access (*i.e. lower jitter*). Throughput and latency varies widely depending on the particular wireless access type (*e.g. HSPA, EVDO, LTE, Wi-Fi, etc.*), not forgetting the service provider. The authors also pointed out (*quite unsurprisingly*), that performance consistency for cellular and Wi-Fi is much lower than for wired broadband, and that larger areas provide higher throughput and lower latency than smaller metro areas due to provisioning efforts by the network operators.

While mobile offloading standards can still be considered to be in a rapid development, and expected to fully breakthrough as a technology part of a future wireless standard, IEEE did already back in 2008 publish a 802.21 standard concerning the support for algorithms enabling seamless handover between networks, process also known as *vertical handover*. Handover can be beneficial for instance in the case when the MT or a laptop with mobile broadband access capability experiences a degradation in the wireless signal, or because the AP experiences a heavy traffic load. More specifically, the IEEE 802.21 standard defines a *media-independent handover* -framework that is capable to significantly improve the handover between different HetNets, but it does not attempt to standardise the actual handover execution mechanism.

In the article (Taniuchi et al. 2009) the authors discussed the way IEEE 802.21 standard framework is addressing the challenges set by seamless mobility for multi-interface devices. The authors also designed a high-level proof-of-concept IEEE 802.21 implementation. The authors of the article (Aijaz, Aghvami, and Amani 2013) estimated, that mobile data offloading will in the near future become a key industry segment, due to the unprecedented pace at which data traffic is rising on wireless networks. Interestingly the authors also noted the new arising business opportunities mobile data offloading brings with it. In addition to cost savings, mobile data offloading can also provide incremental revenue opportunities through different value added services and upselling of existing mobile data bundles as either flat fee, roaming charges, or even as a free feature that can be then charged through the accumulated usage.

There are two types of offloading (Lee et al. 2013):

- On-the-spot offloading

On-the-spot offloading uses spontaneous Wi-Fi connectivity and it transfers the data as it is needed. Most of the current smartphones support on-the-spot offloading by default.

- Delayed offloading

In delayed offloading each wireless data transfer is associated with a deadline with which the data must be transmitted. The data transfer is completed and resumed whenever getting in the coverage of a Wi-Fi AP until the transfer is complete. However, if the transfer does not finish within its deadline, cellular networks finally complete the transfer.

The authors also brought up an interesting notion of carriers reimbursing the customers for voluntary delays in their mobile traffic (*i.e. delayed offloading*) in situations where immediate network access is not absolutely necessary. The main motivator for the network carriers to pay users for deferred data would be to alleviate the wireless network usage peaks to a some extent.

In (Gao et al. 2013) the authors investigated the economics of mobile data offloading through third-party Wi-Fi or femtocell APs, and proposed through their explicit, albeit rather complex game theoretic models and analyses, a market-based data offloading solution, in which the macro BSs would pay these APs for offloading their traffic. In a quite similar topic, the authors of (Paris et al. 2013) proposed a market system, in which a mobile operator can lease the bandwidth made available by third parties (residential users or private companies) through their APs in order to increase the wireless capacity and save energy. The authors also devised different payment algorithms and rules for the bandwidth compensation.

Wi-Fi connections can typically provide higher speeds, whereas cellular technologies generally provide more ubiquitous coverage. The MT or laptop might therefore want to use a Wi-Fi connection whenever one is available, and revert to a cellular connection once the Wi-Fi becomes unavailable. This automatic switching technique from one technology to a different one in order to maintain a constant network connection is known as *vertical handover* or *media independent handover* (MIH), and this type of a network in general can be referred to as *inter-access network*. In (Bathich, Baba, and Ibrahim 2012) the authors pro-

posed a vertical handover mechanism between WiMAX and Wi-Fi networks with the help of MIH, that was based on predefined QoS and SNR parameters. The authors also compared SNR and RSSI based handover performances together, and found that SNR based vertical handover seemed to have a higher overall throughput.

The authors of (Akkari, Tohmé, and Doughan 2007) brought up a scenario, according to which if it is not possible to guide the handover to a different access network capable of providing the same QoS and context parameters (*i.e. if the vertical handover could not be performed*), it will be guided *horizontally*. The user is thus handed over to the same access technology instead. In the paper (Lee et al. 2013), the authors presented a quantitative study on the performance of 3G mobile data offloading through Wi-Fi networks. The authors noted, that offloading traffic in this manner brings a very large benefit both in amount of mobile data saved (65%) and also in the amount of battery saved (55%) without causing any delays to the wireless traffic.

Vertical handover is not to be confused with horizontal handover (which is sometimes also known as *intra-access network handover*). In horizontal handover the user moves between two cells of the same network type ('Considerations of horizontal handover and vertical handover' 2007). An example of a vertical handover would be for instance a handover from a 3G to a Wi-Fi network, and an example of a horizontal handover would be a handover from one mobile cell to another in the same network (*e.g. 3G to 3G*). The main differences between horizontal and vertical handover are listed in table 1.

Property	Horizontal handover	Vertical handover
IP address	Changed	Changed
Access technology	Not changed	Changed
Network interface	Not changed	Liable to change
QoS parameters	Not changed	Liable to change

Table 1. Main differences between horizontal and vertical handover.

The main technological differences in capabilities of horizontal and vertical handover are listed in table 2 on page 89.

Property	Horizontal handover	Vertical handover
Access technology	Single technology	Heterogeneous technologies
Network interface	Single interface	Multiple interfaces
Amount of used IP addresses at a time	Single IP address	Multiple IP addresses
QoS parameters	Single value	Multiple values
Network connection	Single connection	Multiple connections

Table 2. Technological differences in horizontal and vertical handover.

4 Future wireless networks and energy efficiency

This chapter brings forward some of the new and emerging wireless communication technologies. It also discusses some of the new wireless technologies that can be expected to materialise in the future due to the demand from the end users, and hence the advances in the research of new technology. Selected topics include emerging 5G technologies, various infrastructure improvements and new innovations at section 4.2 on page 95, and visible light communication at section 4.3 on page 105.

4.1 5G

5G (*also known as the 5th generation wireless systems, or beyond 4G, or beyond 2020 mobile communications technologies*) is one of the upcoming buzzwords for the future's mobile communication world. It can be seen as a user-centric network, as opposed to the operator-centric approach seen in 3G and the service-centric in 4G. 5G is not yet detailed in any particular specification in any official document by any telecommunication standardisation body. However, the 5G terminals are expected to be software defined radios that are able to utilise access to different wireless networks simultaneously. They are expected to be capable to download and incorporate new modulation schemes and error-control schemes into use, and they should also be able to join different data-flows together from different technologies (so called *multi-mode MTs*). The network is going to be the party responsible for handling the user-mobility, while the MT will make the final choice among different wireless network providers for a given service (Janevski 2009).

Also, greater wireless spectrum allocations, highly directional beamforming antennas at both the MT and BS, longer battery life, lower network outage probability, much higher bit rates in larger portions of the wireless coverage area, lower infrastructure costs, and higher aggregate capacity for many simultaneous users in both licensed and in unlicensed spectrum (Wi-Fi and cellular) are expected from 5G in an article by (Li et al. 2009). The article also predicted, that the backbone networks of 5G will move from copper and fibre to millimetre-wave wireless connections.

At the moment the entire wireless spectrum available for mobile communications is over 1.1 GHz, and in addition to that, a large amount (about 500 MHz) is reserved for unlicensed spectrum at the 2.4 GHz and the 5 GHz ISM-bands¹. By the year 2020 the amount of wireless spectrum available for mobile broadband may increase by up to 10 times, therefore global coordination work will be required to achieve that target. The next major technology step in the wireless interface will be LTE-Advanced, which is expected to raise the spectral efficiency and thus offer peak transfer rates of over 1 Gbit/s. The wireless evolution will not however stop with LTE-Advanced. Digital processing power will continue to grow to meet the increasing data rates in the MTs. RF-technologies will continue supporting wider bandwidth, and wider optical fibre deployments will continue providing faster connections to the BSs ('10 x 10 x 10 the formula for beyond 4G' 2012).

More densely deployed BSs will result in HetNets with radio nodes varying from stand-alone BSs to systems with centralised processing, which is why so many diverse RATs, including LTE, HSPA+, Wi-Fi and "Beyond 4G", will have to be integrated flexibly. In addition to that, the available wireless spectrum will be more fragmented than ever and may even be shared among the operators according to new network leasing models. The diverseness of the wireless equipment in the HetNets will have a wide range of unique performance demands. Cognitive radio networks will play a vital in this due to the fact that they will enable flexible wireless spectrum management, D2D (*device-to-device*) networking and wideband software-defined radio ('10 x 10 x 10 the formula for beyond 4G' 2012).

Surveys regarding the concepts and contents for what functionality is expected to be included into 5G and how the future's networks ought to be powered, have been brought up by the authors of (Gohil, Modi, and Patel 2013) and (Wang and Rangapillai 2012, in which the authors also considered the *greenness* of 5G technology to some extent). The latter article also reasoned that in order to improve the performance of 5G networks over the existing 4G networks, multiple standards in a single device and single platform must be implemented, with a hybrid multiple access scheme along with the use of CDMA-OFDMA.

1. Industrial, Scientific and Medical (ISM) bands refer to the operation of equipment or appliances designed to generate and use local RF-energy for industrial, scientific, medical, domestic or similar purposes, excluding applications in the field of telecommunications.

Authors of (Li et al. 2009) proposed a model for a multi-network data path for 5G networks, in which the data is sent to and from the MTs sporadically via different paths. To corroborate the presented theoretical models and claims of the article, the authors also ran simulations for evaluating the performance of the multi-network data-path scheme. Millimetre-wave frequencies, due to their much smaller wavelength and the size of the antennas, may exploit polarisation and new spatial processing techniques, such as massive MIMO and adaptive beamforming (Rusek et al. 2013).

Although the underlying MIMO theoretic concepts are well understood, cooperative systems are still in their infancy, and much more further research is still required in order to be able to fully understand these systems and to be able to achieve the full benefits from multi-base cooperation. Unlike in standard MIMO systems, where the cost of multi-antenna processing lies in the extra hardware and software at each individual device, cooperative MIMO techniques do not necessarily require any extra antennas. Rather, the cost in cooperative MIMO lies in the additional exchange of information (*i.e. user data and channel state*) between the devices engaged in the cooperation, or between the devices and the central controller in a centralised architecture. Furthermore, the information exchange is subject to tight delay constraints, which can be difficult to meet over a large wireless network (Gesbert et al. 2010).

The future wireless communication systems face a number of key challenges that must be addressed in order to maintain an acceptable level of energy efficiency and affordability – the most influential being (Baldemair et al. 2013):

- The large growth in traffic volume.

The traffic volume has grown tremendously in recent years, fuelled primarily by an enormous uptake in the use of mobile broadband – it can be safely expected that this trend will also continue in the future. Just by straightforward extrapolation, one may expect a several hundred-fold traffic increase within the next ten years, and even further growth beyond that. This traffic increase will to a large extent be driven by further increase in mobile-broadband usage.

- Growth in number of connected devices with diverse requirements.

In the future, the human-centric connected MTs are expected to be surpassed tenfold by wireless devices related to communicating machines, including surveillance cameras, smart-home and smart-grid devices, connected sensors, etc.

- Differing requirements and characteristics for the future wireless systems.

While mobile-broadband access still remains as the dominant application for future wireless systems, a major difference is that ever higher data rates should be available essentially anywhere and anytime, and very high bit-rates should also be supported as needed. Additionally, applications where wireless machines communicate with other machines are expected to become more popular (*e.g. safety or control mechanisms in process industry, remote cameras or smart-grid products*).

- Affordability and Sustainability

Cost of wireless communications will remain a key factor in the future, along with the way the energy for the communications is produced.

In order to match the above challenges, new advances in technology components are required, either in the form of evolved versions of already existing wireless technologies, or as building blocks for new 5G wireless access technologies for specific scenarios and use cases.

In the article (Rappaport et al. 2013) the authors discussed the motivation for new mm-wave cellular systems for 5G, their methodology and hardware, and offered suggestions for the applicable frequencies for the new wireless systems. The authors noted an interesting point, that the today's cellular systems are limited to a carrier frequency spectrum ranging only between 700 MHz and 2.6 GHz – and of that range, only 780 MHz is actually reserved for the worldwide wireless spectrum bandwidth allocation for all cellular technologies combined. Being able to serve both the legacy users with older and often hence energy-wise inefficient cellphones, as well as the customers with the cutting edge newest smartphones, requires simultaneous management of multiple technologies in the same bandwidth-limited wireless spectrum – from energy efficiency standpoint, this is not the optimal or desired situation. The authors also conducted extensive real-world measurements of the propagation characteristics of 28 and 38 GHz wireless signals in urban areas. Their studies conducted at 28 and 38 GHz

showed that consistent coverage can be achieved by having BSs with a cell-radius of 200 metres.

In the article (Khan, Pi, and Rajagopal 2012) the authors proposed a millimetre-wave mobile broadband system for 5G systems between 3 ... 300 GHz, and discussed the advantages of millimetre waves in general, such as vast spectrum availability and large beamforming gain in small form factors. The authors also ran simulations for their implementation of a mm-wave mobile broadband-system, and noted, that with their configuration it is possible to achieve a 10-100 times cell throughput and cell-edge throughput improvement over the existing 4G systems. The gain happened to be in line with the increased system bandwidth used in their mm-wave mobile broadband-system (500 MHz – which is 25 times more bandwidth compared to the 20 MHz in LTE).

The radio is only one small part of today's smartphones. The next generation wireless devices will have a built-in support for a vast array of user services accompanied with a powerful operating system and a complex communications engine. Ubiquitous network access will be essential in supporting these new applications and services with optimal energy efficiency overall ('10 x 10 x 10 the formula for beyond 4G' 2012).

In future wireless networks, the radio resources will be distributed intelligently to achieve the lowest energy consumption possible. Hence, instead of offering a uniform radio access with varying delivery capabilities, services could be delivered more intelligently to take into account the operational environment as well. Context sensitive variables could include for instance the existence of other access networks, the availability of radio bandwidth, the radio propagation environment, user mobility patterns and cost. Additionally, the quality of the wireless connections could be set according to available network and air interface resources. It is also expected, that the radios in the MT will be able to perform local RRM and assist with network resource management. The figure 19 on page 95 illustrates the major architectural differences in the existing wireless technologies compared to LTE-Advanced ('2020: Beyond 4G Radio Evolution for the Gigabit Experience' 2011).

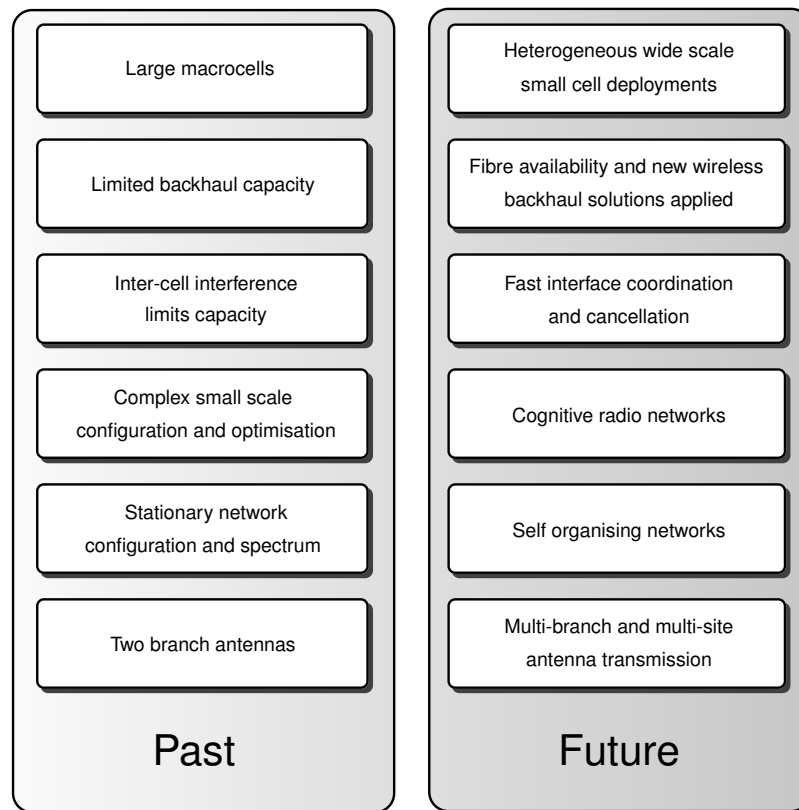

Figure 19. Advances in LTE-A compared to existing technologies.

4.2 Infrastructure improvements and new innovations

In the article (Tombaz, Västberg, and Zander 2011) the authors analysed the design limitations for future very-high-capacity wireless access systems, as well as their impact on the overall system architecture. The traditional mobile systems have primarily been limited by the available bandwidth, but for the future, the high-capacity data systems are going to be increasingly constrained by the energy and the infrastructure costs.

Some fundamental assumptions and expectations for future wireless infrastructures can be summarised as (Tombaz, Västberg, and Zander 2011):

- It's not only the energy cost, but also the total access network cost, that are heavily influenced by the number of network BSs. If the energy cost is high, the total cost will be minimised for dense BS deployments.
- In high-density scenarios, the idle power of the BSs as well as in the backhaul will rise

as a significant factor.

- The cost of energy is also strongly reliant on the amount of available spectrum. Significant cost savings in both energy and infrastructure can be made if more spectrum can be brought available.

The optimisation of the MT's power consumption is vital in current devices, and will also remain as a key factor in the future as well, due to the fact that the battery technologies improve very slowly compared to the evolution of other technologies.

For MTs that use the Internet to a great degree, improvements in web caching techniques can also bring significant energy savings due to the decreased need to access the network (Sailhan and Issarny 2002). An alternative solution to relying to BSs for accessing the Internet is to use so called *ad-hoc networking*, where the WLAN hotspot is reached in multiple hops as opposed to direct access. There are also proposals for concepts where the web content is being shared and cached between those ad-hoc nodes so as to make the web access seem ever more faster.

There are also ways to implement optimised task schedulers for MTs, which aim to meet the deadline for the time limited task in hand by calculating the correct CPU voltage (DVS), and speed for the processor to compute the task, and to make the task's deadline (Limin and Deyu 2006). Energy is of course also consumed for example in the display, loudspeaker and the device's CPU, but those were selected to be omitted in this thesis in order to better focus on the network issues.

The potential for very long standby and call times of the MTs today have been made possible by employing schemes like *discontinuous transmission* (DTX), and *discontinuous reception* (DRX). DTX in essence just periodically creates time-slots in the transmission protocol, during which the power consuming components in the device can be switched off. DTX is not however feasible (nor supported) in the BSs (in WCDMA/HSPA specifications), as it needs continuous pilot signal transmission. This limitation has already been improved to a certain degree in LTE, due to the fact that the cell specific reference signals are no longer being transmitted continuously – although frequent transmission of synchronisation signals and the broadcast channel still remain.

DRX has similarly the potential for power consumption reduction in the MTs by shutting down most of the MT's radio circuitry if there aren't any packets to be transmitted or received. While shut down, the MT only listens to the downlink channel occasionally and may not even keep in sync with the uplink transmissions. In addition, the MT will need to scan the neighbouring eNodeBs to detect any signal quality degradation compared to the serving eNodeB. Should the signal quality of the serving eNodeB prove to be inferior compared to a neighbouring eNodeB, the MT would have to either momentarily exit the DRX mode in order to perform a handover into the superior eNodeB, or perform a cell reselection, after which the DRX may recommence. The MT's battery savings depend on the DRX parameter settings. On the other hand, as the energy savings gained from DRX build up, so do the packet delays of the MTs engaging in DRX, which can translate to incompatibilities with some time sensitive applications (Bontu and Illidge 2009).

In the article (Cui, Luo, and Huang 2011), the authors brought up a joint power allocation scheme and proposed an algorithm called *Joint Minimisation Power Consumption Algorithm* (JMPC-PA). In JMPC-PA multiple transmitters are collaboratively able to select the optimal transmission power with which data can be transmitted over to the users using multiple orthogonal sub-channels. Their optimal power allocation -scheme takes advantage of the good channel conditions in such a way that, upon good channel conditions, more power with a higher data rate is sent over the channel. Should the channel deteriorate again, less power could be sent over the channel.

The basic idea of such cooperative communications is that the nodes in wireless networks can help each other to coordinately transmit the signals, so as to be able to jointly achieve better quality links, or even higher data rates. One typical such technology is called *COordinated Multi-Point* (CoMP) transmission, which has been considered as an effective tool to improve the coverage of high data rates and the cell-edge throughput of LTE-Advanced (3GPP 2013a) and (Cui, Luo, and Huang 2011). Essentially two coordinated transmission points jointly transmit using their constrained power to the users over multiple orthogonal sub-channels by exchanging the channel state information (Luo et al. 2010).

CoMP is considered for LTE-Advanced as a way to enhance the coverage area of high data rate communications, the cell-edge throughput for the MTs, and as a way to increase the

system throughput in varying load conditions. CoMP is used to coordinate the transmissions with several cells and to reduce the interference from neighbouring cells and thus reducing the power required to hold a certain QoS.

In the article (Cao et al. 2010), the authors analysed the energy saving performance by turning off certain BSs with average outage constraint in three typical cooperation schemes: single BS transmission, BS cooperation and wireless relaying. They also investigated the effect of the system parameters (traffic intensity and network density) on the energy efficiency performance.

In (Ismail and Zhuang 2011), both network cooperation for large and small-scale traffic fluctuation was modelled and analysed. For large-scale fluctuation, the networks with overlapped coverage could alternately switch their BSs on or off according to the long-term fluctuations in the traffic load. On a small scale, each active BS can switch its wireless channels on and off according to the short-term traffic load fluctuations.

WMNs are also developing rapidly, and they are expected to resolve the limitations of ad-hoc networks, WLANs, WPANs and WMANs, as well as to crucially enhance their performance. WMNs are able to deliver a wide variety of wireless applications in everyday life in public and in private use. Even with all of the recent developments, much work still remains to be done in the various WMN protocol layers. Due to the possibility to deploy WMNs over the existing wireless technologies, some companies have already launched their rather pioneering WMN products for sale.

Practical experience however tells that WMNs can, and ought to be improved in several areas, as researched by the authors of (Akyildiz, Wang, and Wang 2005) and (Benyamina, Hafid, and Gendreau 2012):

- Scalability

The overall network performance indicators (throughput, end-to-end delay and fairness) are not scalable with the amount of nodes or the network hops. The issue can be eased somewhat by increasing the capacity in the network nodes, for instance by utilising multiple radios or channels in a node, or by utilising radios with higher communi-

cations speeds. These enhancements will not however completely solve the problems – the relative performance over the increased network capacity is not affected. New MAC, routing and transmission protocols however will.

- Self-organisation and self-configuration

These imply that all of the WMN protocols were fully distributive and collaborative – this is not however currently true.

- Security

Current security procedures leave WMNs partially unprotected against security attacks in different protocol layers.

- Network integration

WMNs are currently fairly limited in their capability in integrating heterogeneous wireless networks, due to the problems in incorporating multiple wireless interfaces and their corresponding gateway/bridge functions in the same WMN router. Software radios may be the answer to this issue.

- Performance

WMNs still lag behind wired networks in terms of throughput and delays.

The most apparent reason for low performance in WMNs (*e.g. poor throughput, high network latency*), is mainly due to the insufficiently planned wireless networks. Some research work has been done in (Qiu et al. 2006) to diagnose the performance bottlenecks and problems in WMNs, such as:

- Multi-path interference
- Link slow down because of congestion or voluntary or involuntary packet dropping
- Large co-channel interference
- External RF noise
- Misconfigurations
- Hardware or software bugs in clients or in the APs.

The article also proposed an efficient troubleshooting system that is able to detect and diagnose faults in a WMN system. In spite of the mentioned shortcomings, WMNs are still a promising emerging technology for the future's wireless networks. Despite needing a cross-layer overhaul, redesign and further research to mend the current bottlenecks, it still has several advantages and applications in a number of different scenarios.

There have been articles describing the potential of using higher wireless transmission frequencies (*e.g.* SHF² and EHF³) in order to improve the capacity- and energy efficiency of the future wireless systems (most notably in satellite communications so far) (Cianca et al. 2011) and (Schiavone and Hendry 2011). Frequency multipliers remain the most effective means of generating terahertz radiation, particularly if the operating frequency is greater than 100 GHz (Xiao et al. 2007) and (Li, Zhang, and Fan 2012).

Frequency bands are regulated by channel plan recommendations from international organisations such as CEPT/ECC and ITU-R, and they span a vast range of frequencies (Hansryd and Edstam 2011), and hence some next-gen microwave *backbone-in-the-air* or *fibre-through-the-air* -technology communications services have been proposed and researched in order to reach the next-generation digital communication services, often characterised by high-speed and stringent QoS requirements.

Higher frequencies won't however solve all of the capacity, performance or energy efficiency -issues in wireless communications – they can instead introduce whole new kinds of questions, such as how to combat the ever decreasing cell radius, precipitation susceptibility resistance, or the absorption spectra of various elements in the air, which can limit the usable frequency bands (*e.g.* oxygen, water, or other molecules). Due to this, the higher frequency bands are thus more suitable for short hops up to a few kilometres in range (Hansryd and Edstam 2011). UWB radio is another candidate technology for future wireless communications. UWB uses very short pulses, so that the spectrum of the emitted signals may spread over several GHz (Elbahhar et al. 2005).

Recently work has been done towards a concept, where a picocell head unit contains both

2. Super High Frequency radio frequencies between 3 ~ 30 GHz.

3. Extremely High Frequency radio frequencies between 30 ~ 300 GHz.

the picocell, as well as many of the functions found normally on the BSC and the MSC. This type of a picocell is sometimes referred to as an *access point base station (AP-BS)*, or an *enterprise femtocell*. An enterprise femtocell unit contains all the complete functionality required to connect directly to the Internet, but without the need for the full BSC/MSC infrastructure. This type of approach can be thus seen as a more cost effective solution. There are also enterprise femtocell implementations (Ubee-AirWalk 2013), where the cells have so called self organising functionality, so that the cells can work together to form a grid with handover between them (UBIQUISYS 2013) and (Tecore 2013).

Having realised that the CRs have the potential to utilise the underused bands without causing too much of an interference, the FCC released a Notice of Proposed Rule Making, essentially allowing the CRs to operate in the unused bands (in the U.S.). There is also an IEEE 802.22 working group formed in November 2004 with the task of defining a CR-based IEEE 802.22 (WRAN) -air-interface for use in spectrum allocated for TV service (Cordeiro et al. 2005). The article assessed the achievements of the work group and predicted that the WRANs might hold good potential for more efficient use of the wireless spectrum sometime in the future, especially in the rural areas.

The community responsible for designing mobile devices is playing a bigger and bigger role in reducing the CO₂ emissions emanating from the manufacturing and operation of mobile equipment. When it comes to energy consumption, the term *always connected* can also be understood as *always drained*. As the future handsets become more and more (computationally) powerful, they will also inevitably consume more and more energy. In the future, it can be expected that power increase will doubtlessly continue to walk somewhat hand in hand with the energy efficiency as well, but the advances in those technologies are unfortunately not developing linearly.

The MTs are gradually becoming increasingly constrained to the power outlet to provide them with more energy, and to recharge the battery more often. It can be said that the battery technology used in the MTs is lagging behind the advances in communication technologies. Unless any new approaches for energy efficiency are developed, the 4G MT users will soon have to be continuously on the lookout for any available power outlets, rather than any available network AP. They are thus becoming once again increasingly bound to a single location

– akin to the legacy landline phones. This scenario is known as the *4G energy trap*. This dilemma leads one of the leading design challenges with the 4G MTs – how to better manage the energy efficiency whilst maintaining the current data transmission bandwidth (Radwan and Rodriguez 2012).

In trying to keep up with the increasing energy requirements in the MTs, many different approaches have been developed by the manufacturers. One option is to use a *synchronous sleep* mode scheduling in the transceivers to time the transmissions happening at certain time slots only in order to minimise the power wasted while keeping the radios listening for sporadic incoming transmissions.

Another approach in IEEE 802.11 was defined by implementing a *Power Save Mode (PSM)*, which is meant for nodes existing in infrastructure-based WLANs. Quite like in synchronous sleep mode, the idea behind PSM is to synchronise the sleep for all of the radios in the network, such that at all times only one of the radios is active (besides the one in the AP of course), and only utilise the radios at the time the AP notifies them individually (via a beacon message). AP buffers packets for each wireless PSM node, and only sends data to a node when it is scheduled to be active. PSM has its drawbacks mostly in poor QoS sensitivity and is thus poorly suitable for applications like VoIP. Wi-Fi Alliance⁴ developed a piece of technology called *WMM (Wi-Fi Multimedia) Power Save* to address this QoS issue (Alliance 2005).

For future wireless innovation development, IEEE has also set up a IEEE P802.15 Wireless Next Generation Standing Committee (SCwng) to facilitate and stimulate presentations and discussions on new wireless related technologies within the defined scope, that may be subject for new 802.15 standardisation projects.

Some research efforts have been made on investigating the energy savings using short-range (SR) multi-hop communications, instead of long-range (LR) communications. In an article by (Fitzek et al. 2011), the authors ran a comparison between data transfer either in a WLAN in ad-hoc -mode, or communicating using an overlay cellular network, and showed that the energy efficiency can be enhanced by using SR multi-hop communications. The authors also

4. The Wi-Fi Alliance is an association devoted to promoting the growth of WLANs.

noted that there are some practical limits on the number of relays that can be used in order to maintain a positive energy- (6 relays), and time- (50 relays) savings compared to the overlay network. Through the knowledge that SR communications typically have a higher bandwidth and smaller energy footprint than LR communications, it can be noted that by combining SR technology with LR technology, positive energy savings can be achieved by relying on cooperative communication. A *Persistent Relay Carrier Sensing Multiple Access (PRCSMA)*-MAC protocol to lessen the need for LR communications in favour of cooperative SR-cluster communications has also been discussed in (Alonso-Zárate et al. 2008).

ODMA (*Opportunity Driven Multiple Access*) is another wireless technology option fairly similar to using relays. In ODMA, the coverage area of the BS is divided into two regions, the high bit-rate and the low bit-rate regions. In ODMA the path between the BS and the MT who is at the low bit-rate region is broken down into a number of smaller radio-hops by relying on other MTs in the cell to relay the signal. The optimal routing between the nodes is calculated using intelligence in the MTs and in the BS to try and achieve the minimum total path loss for the transmission (Rouse, McLaughlin, and Haas 2001) and (Rouse, Band, and McLaughlin 2002). The authors of the article (Lin, Lai, and Gan 2004) evaluated the performance of ODMA and compared it to a non-ODMA network. The authors noted in the article, that ODMA significantly improves the average transmission rates especially in low traffic load conditions.

In an article by (Radwan and Rodriguez 2012), the authors brought up the concept of selling and buying transmission credits between the network nodes. A MT with a low battery, or a poor connection to a remote LR AP, might opt to use its transmission credits to buy a more energy efficient LR connection link to the LR AP via another SR node's LR link, assuming of course that a seller node within a sufficiently good radio connection to the AP is found (*i.e. one that obviously has a higher energy efficiency -link*), and it is willing to sacrifice some of its own energy resources for the buyer. Notwithstanding the fact, that the cooperation requires SR communication between the two nodes, as well as LR communication for the other node, and in addition some cooperation overhead between the two nodes, this type of a collaborative network concept still yields higher overall energy efficiency from cooperative SR-cluster communication.

The mentioned overheads could include, *inter alia*:

- Node discovery
- Context gathering, -maintenance and -distribution
- Cluster formation and maintenance.

The energy consumption savings in SR-LR cooperation depends chiefly on the achieved data link rates on different channels (both in LR and SR), as well as the total power consumption based on the active interfaces. Using the mentioned cooperation, the total transmission time is decreased, and hence the sleep time in the nodes is increased. Keeping the nodes inactive and thus in their sleep mode as frequently as possible, helps reducing the overall energy consumption. This cooperation technique doesn't necessarily produce any network-wide energy efficiency improvements per se, but it's mainly aimed rather for improving the energy efficiency in an individual node only.

The authors of (Radwan and Rodriguez 2012) also ran some simulations with different combinations of radio technologies, and found that using WiMedia as SR and Wi-Fi as LR yields the best possible energy efficiency in the network. It is also worth mentioning, that the Wi-Fi-technology they used in their experiments was the rather old and comparably slow IEEE 802.11g (54 Mbit/s max. throughput) – more modern and faster Wi-Fi technologies (IEEE 802.11n or IEEE 802.11ad for instance) might have resulted in different outcome in the simulation.

In future networks, the RF complexity in the devices will grow with the need to support multiple new wireless bands and duplexing methods, carrier aggregation and heterogeneous network operation. Just like some wireless technologies today, future devices will also be able to optimise their performance by using radio sensing to capture and assess the RF environment. RF sensing uses advanced technologies for new and existing radios to sense the wireless environment and provide new applications and services, such as indoor positioning and mobile radar ('10 x 10 x 10 the formula for beyond 4G' 2012).

More advanced beamforming schemes to support SDMA, and to increase the channel capacity, such as closed-loop beamforming (Jiang et al. 2012) and multi-dimensional beamforming (Gheryani, Wu, and Shayan 2009) have also been proposed in order to increase the energy ef-

efficiency of the future's wireless communication systems. Additionally, location-based beamforming (*e.g.* GPS) that the authors of (Maiberger, Ezri, and Erlihson 2010) discussed can be seen as one candidate for eliminating the need for precoding specific signalling or feedback in many common scenarios.

In an article (Al-Kanj and Dawy 2012), the authors devised a method for a BS to multicast the content over a cellular network to a selected set of MTs, who in turn multicast the content over to other MTs in their vicinity, which leads to the formation of cooperative groups. The results of the (two) formulated optimisation algorithms presented in the paper demonstrate notable energy efficiency improvements in various wireless scenarios. Their formulated problem, its solution, and the simplified multicasting formulation are generic, and can as a consequence of this be applied to a wide range of network scenarios with different geographical topologies, channel models, and wireless technologies.

Recent similar work has also been done by (Chang and Ristaniemi 2013), where the authors introduced a scheme with which the MTs in a wireless network can form a *distributed mobile cloud* (DMC). In a DMC the MTs will collaborate using SR links, and the idea is that they share the data gathered from a remote AP with each other in order to save energy by avoiding the use of *energy-wise* costly LR communication link with the AP. The idea is to exploit the fast and low-energy SR communications link within the cloud instead of only using the relatively slow and potentially high power and lossy LR link. The article also analysed (*amongst other things*) the possible energy efficiency gains achieved with this method, and estimated the maximum number of distances between the SR links, and compared the energy efficiency vs. the inter-device distance with a set number of MTs. This idea of DMC collaboration and its effects on energy efficiency is further examined in chapter 5.

4.3 Visible light communication

Visible Light Communication (VLC) (*colloq.* *Li-Fi*) is wireless data communications technology standardised by IEEE 802.15 WPANTM Task Group 7, that uses visible light in the 380 ~ 780 THz frequency range. VLC research is gaining a growing interest mainly because of the easy implementation of uni-directional broadcasts via visible light using only a

low-cost and omni-present LEDs and regular photodiodes (PDs), or image sensors as the receiving device. The basic principle of VLC communications is that the VLC transmitters can modulate the intensities of the used lighting sources, (*e.g.* LEDs), at such high frequencies that human eye cannot perceive any difference in lighting compared to the situation when there is no modulation. As a consequence of this, VLC transmitters can be used for both lighting and data communication simultaneously.

The primary function of a white LED is to provide illumination, which is also why the core advantage of using VLC is the duality in the use of the visible light both for illumination and for wireless data transfer. Other possible light sources to be considered for use in VLC besides existing incandescent lightbulbs, normal LEDs or halogen lamps include micro-LEDs, phosphorus LEDs, RGB LEDs, resonant cavity LEDs and laser diodes (LDs). There are currently two types of white LEDs on the market that are able to produce white light. A 3-chip LED, that mixes the three primary colours (red, green, and blue), and a 1-chip blue light LED that excites yellow phosphor resulting in white emission (Cui et al. 2010). Out of these two LED types, the 1-chip is dominant due to its good applicability to mass production.

Authors of (*Spot-diffusing and fly-eye receivers for indoor infrared wireless communications* 1992) reasoned that a LD would be an ideal choice for a VLC network in the sense that it has a large bandwidth, high output power and a coherent (and monochromatic) wavefront. Particularly, the coherent wavefront makes it possible to have a well collimated beam, which means no restriction on the size of the diffusing spot. RGB-LED VLC-system was tried and tested in practice successfully by the authors of (Komiyama et al. 2011). The authors analysed the characteristics of both the variation in colour and change in intensity of each RGB LED and RGB sensor.

The slow response of the phosphor limits the modulation bandwidth for white emission. However, improved modulation bandwidth is achievable by using only the blue emission component (*e.g.* by placing a blue optical filter at the receiver). This has a drawback of blocking a significant amount of the emitted energy. As an alternative, a receiver equaliser can be used to compensate for the source. For the equalised case there is an SNR penalty of approximately 18 dB due to the equaliser. For the blue filtering, approximately 10% of the power is in the blue emitted component (Zeng et al. 2009). Through simulations the authors

also noted that the blue channel is not very well suited to MIMO at high speeds, as the power in the blue component, filter losses and low responsiveness lead to very large receivers in order to collect enough power for the correct detection.

The equalised and white components have comparable performance in terms of receiver size and data rates, but for a specific data rate, the white LED based system requires more channels as the individual channel rate is lower. When it comes to performance in the terms of data rate, equalised channel has the potential to provide Gbit/s rates, albeit with a large receiver array. Imaging diversity and multi-beam transmitters were discussed in (Kahn et al. 2002). The authors of the article successfully designed a 100 Mbit/s infrared-multi-beam link, quite similarly as in an earlier article (*Spot-diffusing and fly-eye receivers for indoor infrared wireless communications* 1992), where the authors coined the term 'fly-eye' for representing multi-receiver configuration.

Generally speaking, there are two kinds of photodetectors that can be adopted in an indoor LOS VLC system design – the PD and the image sensor. The PD has been widely adopted in optical communication systems with relatively large received optical power. The advantages of the PD include its low price and possible high reception bandwidth. The bandwidth of the PD is usually inversely proportional to its active receiving area due to the internal capacitance along this area. Compared with the PD, the image sensor is able to provide receiver spatial diversity to enhance the detection performance and supply additional source location information for location-aware services. For application scenarios where multiple LED arrays in a room send different signals to multiple users, using a large field-of-vision PD may lead to large interference that degrades received SNR. In this case an image sensor would better serve as the light detector that could effectively discriminate different LED arrays and reduce inter-array interference (Cui et al. 2010).

Modern smartphones and other comparable mobile devices are already equipped to receive visible light communications via the camera, but the technology is still quite immature, and because of that, VLC lacks a steady standard to back it up. With VLC, high order wireless MIMO transmissions (*of X-resolution * Y-resolution*) are possible due to the spatial separation of multiple light sources in a digital camera (Roberts 2013). One main challenge for VLC is the limited modulation bandwidth of the light sources, which limits the achievable

data rates.

As the room or coverage space would typically be illuminated by an array of LEDs anyway, the potential for parallel data transmission becomes increasingly apparent – this is also why using optical MIMO techniques is potentially attractive for achieving high data transfer rates, as noted by the authors of (Zeng et al. 2009). The authors also compared non-imaging and imaging MIMO approaches, and noted that a non-imaging optical MIMO system does not perform properly at every receiver positions due to symmetry, but an imaging based system can operate under all foreseeable circumstances. The authors also ran simulations and showed how such systems can operate at several hundred Mbit/s, and even at Gbit/s in many circumstances.

The parallel free-space optical interconnects between the source and detector arrays typically require a precise alignment to map a source to a particular detector, or a group of detectors, and they can achieve this by design of the physical system. MIMO allows the alignment required for such an interconnect to be achieved in hardware, as it is not necessary that light from a source precisely strikes a specific single detector. In addition, due to the fact that the source and detector are typically in motion relative to each other, it is as a result not always possible to precisely align the detector and receiver array. MIMO techniques can be used to *learn* the channel matrix, thus quantifying the crosstalk between the channels created by each source and detector – this can subsequently be used to estimate the transmitted data. Hence the motivation for using MIMO is not for increasing the wireless capacity as is, but rather to reduce the difficulties in achieving optical alignment physically by using electronic signal processing (Zeng et al. 2009).

Once deployed, possible benefits of VLC can include:

- High security due to the possibility to utilise optical lenses to form a narrow beam for the link, or due to the possibility to obscure the communication within the ambient visible light thus hiding the communication entirely in the overall illumination.
- Immunity to RF interference and RF band congestion.
- Low additional cost when compared to using the LEDs purely for illumination pur-

poses.

- VLC technologies do not, *as of yet*, require any licenses to use, unlike many RF bands do.
- VLC can be implemented at a place where radio waves cannot be used (*e.g. hospitals or near sensitive precision equipment*).

High speed wireless VLC transfers do have their challenges as well, due to the following items recognised by (Pisek, Rajagopal, and Abu-Surra 2012):

- Ideally, the channel between the light source and the light detector needs to be in LOS, or it should use reflections, or both. The channel should also be quite short (only up to few metres).
- The light from the source has to be focused directly on the light detector due to the light detector's low sensitivity at high transfer rate.
- Light detectors are typically sensitive to ambient light and interference from adjacent light resources.
- Channel bandwidth can be increasingly high, which in turn increases power consumption. There are however ways to limit the channel bandwidth, namely with the help of line coding.

There are a number of different modulation schemes that can be used to send data over the visible light spectrum:

- On-Off Keying (OOK)

As the name implies, the data in OOK is carried by switching the light source(s) on and off. In its simplest form, a digital '1' is represented by the light power-on state, and a digital '0' is represented by the light's power-off state. The elegance of this method is that OOK is really simple to generate and also to decode. Regardless, this method is still not optimal in terms of illumination control and data throughput.

- Pulse Width Modulation (PWM)

This modulation method transfers information encoded into the duration of the light

pulses. More than one data bit can be transferred within one pulse, but the pulses may have to be longer than for OOK, which is why this scheme lacks a particular finesse. It is also possible to transmit data in an analogue format using this scheme. Quite like OOK, PWM is also a relatively simple modulation scheme to implement.

- Pulse Position Modulation (PPM)

In PPM the transferred data is encoded using the position of the pulse within a frame. Again, more than one bit is possible to be transmitted within each pulse, and also the duration of the frames should be longer compared to a single OOK-bit, so again it is not more efficient per se. It does have the benefit of containing the same amount of optical energy within each frame though.

- Variable Pulse Position Modulation (VPPM)

VPPM is similar to PPM, but it allows the pulse width to be adjusted for the purpose of dimming the lights.

- Pulse Amplitude Modulation (PAM)

As the name implies, the information in PAM is carried by the amplitude of the pulse. A number of data bits could be conveyed in a single pulse (*e.g. off = 00, 1/3 amplitude = 01, 2/3 amplitude = 10, full amplitude = 11*). With this example, four different amplitude levels are used to carry two bits of information. PAM can carry more data in each pulse than OOK, but it is more complex and more susceptible to noise or interference on the optical channel.

- Colour Shift Keying (CSK)

CSK can be used if the lighting system uses RGB type LEDs. By using the combination of different colours of light, the output data can be carried by the colour of the light itself, so the intensity of the output can be left constant. The drawback of this system is the inherent complexity in both the light transmitter and in the receiver.

- OFDM

This modulation scheme has been widely deployed for instance in digital TV, radio and for Wi-Fi. OFDM can be modified for use in optical communications and it uses a set of sub-carriers each at different but harmonically related frequencies. OFDM has a number of advantages including good spectral efficiency, but as a consequence of this, this modulation method is also quite complex to implement.

- Spatial Modulation (SM)

There exist a number of techniques that could allow one to determine the source of an optical signal. In SM, if one can determine the optical signal source, one can then either use the multiple sources of information to transfer multiple streams of independent data (one from each source), or use the source of the signal as part of the information encoding itself. The multiple optical signal sources could be for instance multiple LEDs within a single fixture.

The electrical drivers for a LED are often used together with an optical amplifier (a special lens) located on top of the LED that would increase the intensity of the emitted light towards a certain direction (which is in a sense optical beamforming). In addition to this, the optical filters (or colour lenses) could be used on top of the LEDs to filter only certain colours to be transmitted, or for instance on the PDs to filter data from only certain LEDs. Different optical filters could be used to transmit different colours to the channel, thus in a way creating a *Coarse Wavelength Division Multiplexing (CWDM)*⁵ -like solution to significantly increase the transmitted bit rate. The receiver also needs to be designed accordingly to support receiving the multiple transmitted data channels coming in a multitude of colours (Chou et al. 2010).

The VLC systems assume free space between the light emitting source (LED/LD) and the light detector (PD). Normally this channel is assumed to be LOS, but there are however many cases in which LOS is not attainable, and due to this the light received into the light detector is essentially only a reflection coming from its surrounding materials. These reflections can also be caused deliberately (*i.e. adding aluminium foils or mirrors to reflect the light from*

5. CWDM enables the combination of different wavelength signals onto a single transmission channel without the signals interfering with each other.

walls and barriers) in order to increase the reflected light intensity at the receiver.

The distance of the channel primarily depends on the transmitted power from the light source driver. However, other than real barriers and reflections, the channel is not intrinsic and there are therefore many different types of interference that can be treated as noise, and as such can thus reduce the SNR. The burden of defeating these interferences and equalising the signal back to its intended form is on the receiver. The light receiver must be carefully designed in order to maximise the signal detection with minimum noise contributions to the overall receiver noise figure. The characteristics of the light receivers are crucial to the performance of the receiver overall, since they are logically at the front of the receiver, and they are therefore the first part that processes the light received from the channel. Just like any other RF receiver, the noise figure of the first receiver stage is the most crucial and it can actually define the quality of the receiver as a whole (Pisek, Rajagopal, and Abu-Surra 2012).

The authors of (Komine and Nakagawa 2004) provided a fundamental theoretical analysis on VLC systems in indoor environment. The authors noted that reflection and inter-symbol interference can severely impede and degrade the communication performance. By means of using more advanced optical techniques and modulation schemes, the VLC link speeds can be increased. In (Minh et al. 2008) a VLC link speed of up to 80 Mbit/s by using pre-equalised white LEDs was successfully demonstrated and in (Vučić et al. 2009) the authors demonstrated a 200 Mbit/s VLC link with phosphorescent white LED lamp modulated by a discrete multi-tone modulation signal link in various lighting conditions. Authors of (Pisek, Rajagopal, and Abu-Surra 2012) proposed and described a novel optical/electrical VLC front-end and baseband systems to enable parallel processing that could achieve a 1 Gbit/s bit rate over free space. The authors also detailed the implementation issues of the low power VLC communication system for a MT. Also simulation results were brought up for a Low Density Parity Check -coding-based VLC system, that did provide high level of parallelism for a energy efficient gigabit rate baseband system.

VLC also has an advantage over some other short range free space wireless standards, such as 60 GHz WiGig, due to the fact that it uses a simple low power front-end scheme rather than high complexity, high power RF front-end that usually involves phased-array antennas to support beamforming, where each antennas are chained and equipped with a low effi-

ciency PA. The 60 GHz WiGig system also uses high power Digital-to-Analog Converters and Analog-to-Digital Converters to support the high modulation schemes (64QAM, etc.) to achieve gigabit communication (Pisek, Rajagopal, and Abu-Surra 2012). In addition, VLC does not penetrate thick materials such as walls – which can in turn be seen as a security advantage over RF-based wireless transmission standards – but as a handicap from mobility’s standpoint. Also the communication distance with VLC is typically only between 1 to 100 meters, which can be again seen as a limitation, or on the other hand as an enabler for more accurate location-based services, such as customer flow analysis in supermarket, or indoor navigation system for the visually impaired (Haruyama 2013). The authors of the article (Hyun-Seung et al. 2011) studied the applicability of VLC to indoor positioning system with the help of an intercell interference mitigation system that the authors also devised.

In a paper by (Deqiang, Xizheng, and Linpeng 2007), the authors analysed the relationship between the optimal indoor (white) LED layout and the received power of the VLC system, whereas in (Cui et al. 2010) the authors demonstrated and optimised a practical indoor LOS VLC system. A typical indoor optical wireless communication receiver front-end would typically consist of a concentrator, an optical filter, a photodetector, a pre-amplifier, a post-equaliser, and an electrical filter.

The major noise sources present in an indoor VLC system include ambient light noise (*i.e. background solar radiation through windows, incandescent radiation, and fluorescent radiation*), signal and ambient light induced shot noise in the photodetector, and the electrical pre-amplifier noise. The ambient light noise induced by background solar radiation and incandescent lamps represents essentially a DC interference that could be easily eliminated using an electrical high-pass filter. The noise induced by fluorescent lamps needs to be determined in different application scenarios based on what kind of driving circuit is used (Cui et al. 2010).

The authors of (Liu, Sadeghi, and Knightly 2011) examined the key issues in enabling vehicular VLC networks. The authors noted that a receiver’s narrow field-of-view angle makes vehicular VLC networks resilient to visible light noise from sunlight and legacy lighting sources as well as to interference from active VLC transmitters. In addition, in dense vehicular traffic conditions (*e.g. urban highway during peak hours*), vehicular VLC takes advan-

tage of multiple available paths to reach vehicles and it thus overcomes the effects of packet collisions. In the presence of a visible light blockage in traffic, vehicular VLC can still have a significant number of successful transmissions by opportunistically using dynamic inter-vehicle gaps. In (Elbahhar et al. 2005), a new inter-vehicle communication system was proposed based on UWB technology with a comparison of two UWB waveforms: coded Gaussian and monocycle pulses. The coded Gaussian pulse waveform was the superior of the two, since the obtained BER was lower than for monocycle pulses.

Possible future applications for vehicular VLC include (BMW et al. 2005):

- Traffic signal violation warning
- Curve speed warning
- Left turn assistant
- Stop sign movement assistant
- Lane change warning
- Cooperative forward collision warning
- Pre-crash sensing
- Emergency electronic brake lights
- and even Internet access

Vehicular VLC also needs dependable security features built in, so as to prevent any malicious user from deliberately and unnecessarily causing the aforementioned safety features from triggering (*e.g. auto braking from pre-crash sensing*).

Other potential examples for the use of VLC devices include indoor location-based services, secure point-to-multipoint communication, intelligent transportation systems, information broadcast, cellular phones, portable multimedia players, personal digital assistants, navigation, visible-light APs, signboards, billboards, traffic signals, in-vehicle illumination, street lamps, visible-light IDs, etc (Won 2008).

Vehicular VLC was studied in (Kim et al. 2012) from the perspective of implementing a VLC network with the help of a *Controller Area Network (CAN)* into a vehicle. Once again the authors had interference problems with sunlight, which were however fixed by using an optical filter and a lens in the light transmitter and in the receiver module. In (Iwasaki

et al. 2008) the authors proposed a VLC road-to-vehicle communication system at intersections using LED traffic lights as transmitters and on-vehicle high-speed cameras as receivers. While experimenting with a real-world VLC system, the authors noted that especially image processing algorithms need further improvement in detection speed in order to improve the communication speed. Quite similarly, the authors of (Chinthaka et al. 2010) researched the communication between a vehicle and an LED traffic light, and proposed new more effective algorithms for finding and tracking the transmitter, which indeed specifically targeted the issues found earlier by the authors of (Iwasaki et al. 2008), thus resulting in increased wireless communication speed.

A LED-to-LED wireless network obscures the exchange of messages in the existing illumination. The exchange of visible light messages has no effect on the level of brightness (in essence the LED appears to be switched on all the time). VLC communication was researched by the authors of (Schmid et al. 2013), in which the authors proposed to use LEDs for both as the transmitters, and also as the receivers, in place of the PDs, which combined with the notion that the evaluated VLC devices consumed almost equal amount of power in idle mode, and during receiving or transmitting. The authors noted, that the LEDs that are charged in reverse bias can be used to receive incoming light. Depending on the intensity of the incoming light, the LED's capacitance discharges at different speeds. The stronger the incoming light, the faster the discharge. With an adaptive threshold parameter, the two different ON/OFF symbols can be determined and differentiated by the receiving VLC device at the end of each slot used for measurements.

LED-to-LED wireless communication can be seen as a positive phenomenon from the energy efficiency point of view, as the LEDs that would normally be used purely for lighting can also act as data transceivers, without any perceivable impact on the lighting quality. A LED-based VLC ad-hoc network, in which the VLC devices would communicate with each other, might in the future achieve a performance level so high, that this approach would be useful for combining smart illumination with low-cost networking, in a sense eventually becoming a candidate enabling technology for the Internet-of-Things⁶.

The authors of (Giustiniano, Tippenhauer, and Mangold 2012) approached VLC from a prac-

6. An Internet-like structure for everyday objects – not just for the computers.

tical point of view by building and testing a four LED VLC-network. The authors implemented a flickering elimination system and a carrier-sense protocol based on free-space optical collision detection to combat the impact of network collisions. The authors also demonstrated that LED sensitivity, physical rate and flicker elimination are tightly correlated, which in turn forces some compromises in the system design.

The authors also noted that using low-cost LEDs for both sending the light information, but also detecting the transmission reduces the amount of components, and while resistances, operation amplifiers, etc. can indeed increase the communication rate and range, they also increase the power consumption and cost per-device. In addition, a normal LED's sensitivity region is only marginally wider than its spectral emission profile, while PDs indiscriminately detect a wide spectrum of both visible and infrared light. Therefore, no additional optical filters are needed for LEDs, which makes LEDs more robust against interference from sunlight and any source of man-made interference.

5 Mobile cluster simulation

The purpose of this section is to experimentally demonstrate the energy efficiency impact of deploying mobile cluster collaboration in the form of a *Distributed Mobile Cloud* (DMC), compared to a non-cooperative scheme – an idea brought up and studied by the authors of (Chang and Ristaniemi 2012) and also later in (Chang and Ristaniemi 2013). The way the concept goes, is that a DMC contains several resource constrained MTs that are all capable to individually receive the data from the AP, and also potentially capable to exchange the received data with each other. The figure 20 on page 117 illustrates the supposition. In the figure, the MTs in the DMC access the AP through their LR-links, while they also have the capability to collaborate and share the data with other MTs, even to those MTs who would otherwise be out of range to the AP, by using D2D communications using SR-links.

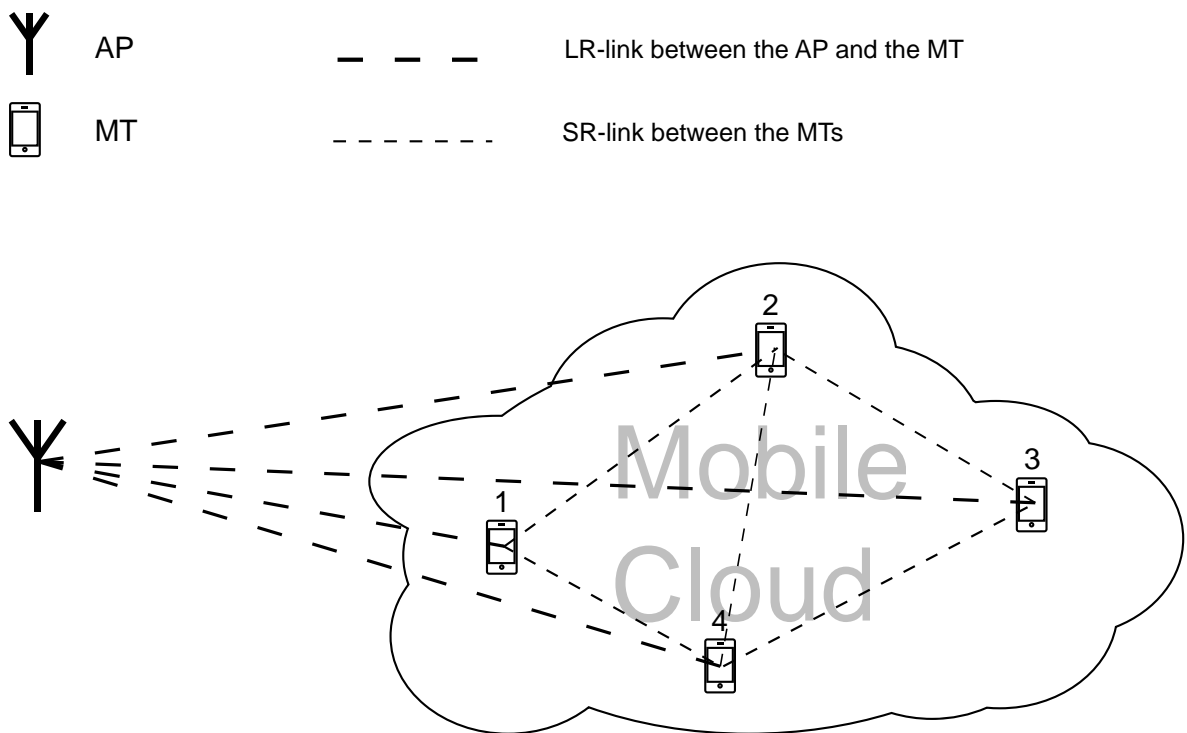

Figure 20. Illustration of round-robin communication.

Since each MT is at a unique distance to the AP, and because of this, each MT also has a different quality radio link to the AP, each MT therefore also has a different power requirement

for successful communication with the AP. The DMC-concept exploits this knowledge by only allowing a certain MT with the *best* wireless link in the cloud to communicate with the AP (typically the MT closest to the AP), and then disseminate the data to the other MTs in the DMC, thus in a way acting as a "bridge" between the DMC and the AP. The figure 21 on page 118 demonstrates the idea. The "bridge" MT in the figure is the MT₁, since in the figure it is physically closest to the AP, and therefore it also has the best wireless connection to the AP. Using DMC-collaboration takes advantage of the good wireless channel of the MT₁, by having it handle the transmissions to the AP in lieu of the cloud. The described situation resembles an ODMA network to a some degree as discussed earlier in section 4.

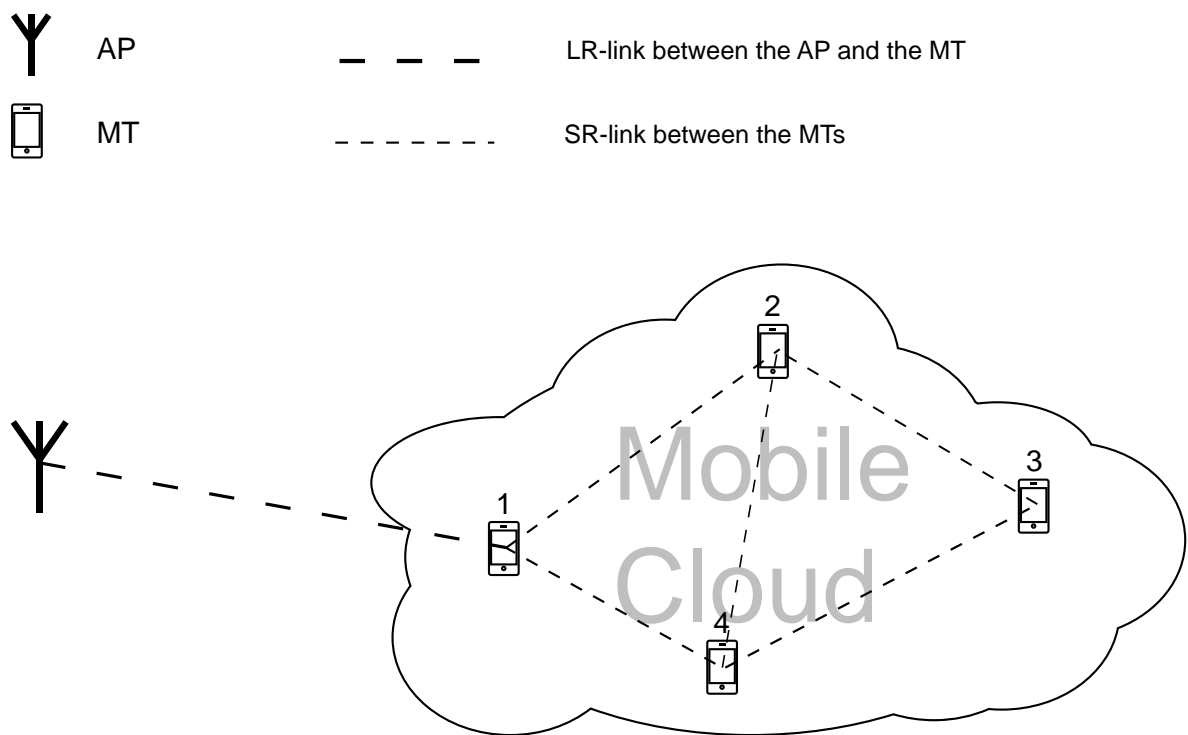

Figure 21. Illustration of DMC collaboration.

This DMC collaboration -method has the advantage of reducing the network's overall energy and resource consumption while simultaneously increasing the data rates for the nodes in the DMC, especially when juxtaposed against a more traditional AP-to-MT (*the round-robin communication -case mentioned earlier*), or even against a more advanced Point-to-Point communication link. The increased data rates are due to the better wireless channels, which enable the use of faster link speeds with more elaborate modulation schemes. This collabora-

tive *best-MT-to-DMC* scenario from figure 21 is then compared against a situation, in which all of the MTs in the DMC access the AP in a round-robin¹ scheduling fashion, as described in figure 20. Round-robin scheduling makes even the nodes whose wireless connections to the AP are poor, to also communicate to the distant AP in sequential order (*for instance MTs 1 → 2 → 3 → 4 → 1*).

The MTs in the DMC all need to be so called *dual-mode* devices, with two radios, one with a SR (*e.g. Wi-Fi or LTE D2D*) wireless capability for inter-device communications, and the other radio equipped with the capability for LR broadband access (*e.g. UMTS/LTE*) for communicating with the AP. Also as a prerequisite, all MTs require the same data from the AP (*e.g. video or digital radio broadcast*), and all MTs are running with an equal data rate at their corresponding radios. Round-robin scheduling was selected for consistency's sake as a method to access the AP.

The SR link is considerably faster and it runs with a lower power consumption compared to the LR link. The figure 22 on page 120 compares the LR and SR communication principles together. The upper diagram shows the power and time requirements for a non-collaborative scenario, in which the AP sends data to each MTs individually with a slower and more energy hungry LR-link, whereas the lower diagram clarifies the benefit of using a DMC when transmitting the same data. In the DMC, the AP needs to send the data to a fewer MTs (the first two boxes) with the slower and more energy hungry LR-link, and in order to improve the energy efficiency of the overall system, the MTs can then distribute the received data with each other using a lower power and a faster SR wireless link (the last two smaller boxes). In the figure it can be assumed that the wireless links are of the same quality and speed, which is also why the consequent bars are equal in height and length.

The total required network energy consumption for transferring data to each MT in the DMC-collaboration in a *best-MT-to-DMC* downlink only situation can be modelled as in formula (5.1):

$$E_{total-best-MT} = AP_{tx} + AP_{signal\ processing} + n (MT_{DMC-tx} + DMC_{signal\ processing}) \quad (5.1)$$

1. Equal time slices are assigned to each MT in a circular order, so as to handle all MTs without any priority.

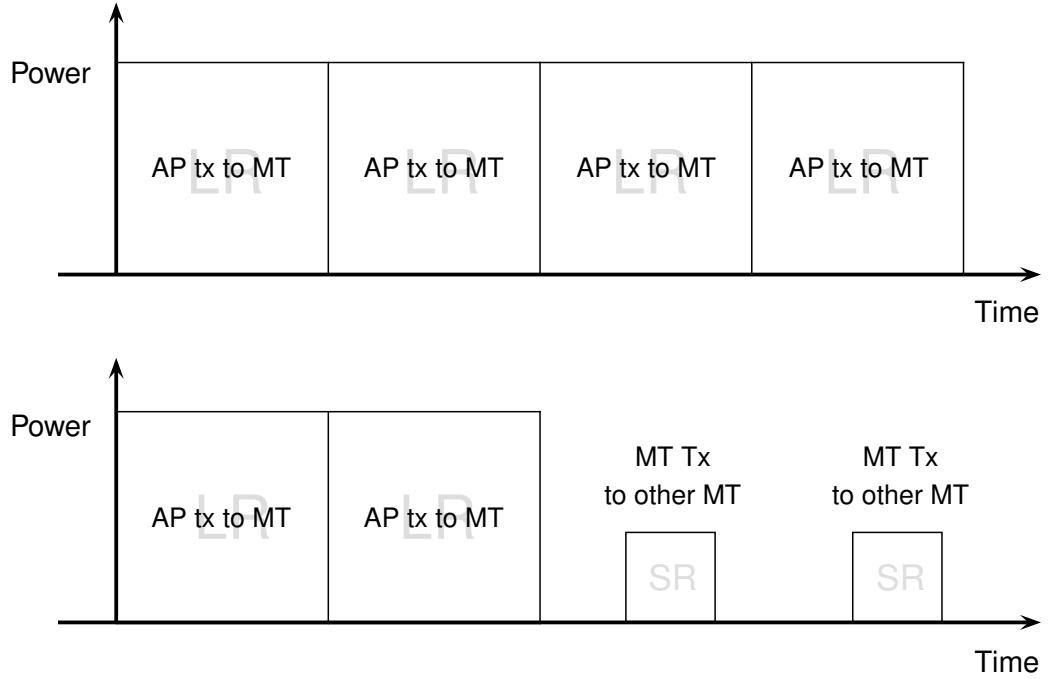

Figure 22. Comparison of a non-collaborative transmit scenario vs. a DMC.

where:

n is the total amount of MTs in the DMC

AP_{tx} is the power consumed by the AP when transmitting the data to a MT

$AP_{signalprocessing}$ is the power consumed by the AP's baseband signal processing

MT_{DMC-tx} is the power consumed by the MT when transmitting the data to the DMC

$DMC_{signalprocessing}$ is the power consumed by the DMC's overall baseband signal processing.

For the round-robin scheduling situation, it can be assumed that the wireless link qualities of the individual DMC MTs are varying considerably when communicating to the AP due to the different distances and hence the radio link qualities between the MTs and the AP. Because of this variance, we can introduce a random variable called *Channel Quality Index (CQI)* into the total power requirements of the AP_{tx} and MT_{DMC-tx} to simulate the arising random quality fluctuations in the radio link to successfully transmit the data. The new variable will be aptly called AP_{CQI} . The total required network energy consumption for downloading the same amount of data to each MT in the DMC with round-robin scheduling can be formulated as shown in (5.2):

$$E_{total-rr} = n (AP_{tx} * AP_{CQI} + AP_{signalprocessing}) \quad (5.2)$$

But since the signal processing energy consumption remains unchanged regardless of the communication arrangement (*i.e.* *DMC-collaboration vs. round-robin -scheduling*), both the $AP_{signalprocessing}$ and $DMC_{signalprocessing}$ can be left out from the equation, thus the above formulas (5.1) and (5.2) can be simplified into (5.3) and (5.4) correspondingly:

$$E_{total-best-simple} = AP_{tx} + n (MT_{DMC-tx}) \quad (5.3)$$

and

$$E_{total-rr-simple} = n (AP_{tx} * AP_{CQI}) \quad (5.4)$$

To be able to then assess the difference between these two methods and formulas, and subsequently the energy efficiency benefit from using only the MT with the best wireless connectivity to the AP over a round-robin scheduling, $E_{total-rr-simple}$ must be divided by $E_{total-best-simple}$, as shown in formula (5.5):

$$E_{savings} = \frac{E_{total-rr-simple}}{E_{total-best-simple}} \quad (5.5)$$

To get the ratio between these two methods.

Formula (5.6) represents a *Simplified Path Loss Model (SPLM)*, which is a general and simple model for analysing the path loss in different environments. With SPLM, the ratio between $E_{total-rr-simple}$ and $E_{total-best-simple}$ from formula (5.5) can be calculated.

$$P_r = P_t K \left(\frac{d_0}{d} \right)^\eta \quad (5.6)$$

where:

η is the path loss exponent, which is determined empirically and it is a function of carrier frequency, environment, obstructions, etc. Typically η ranges from 2 to 8.

K is a constant factor

P_r is the received power at the receiver

P_t is the transmitter power

d_0 is the reference distance (typically in indoors 1 m)

d is the distance of the receiver

Despite its name, the SPLM-formula brought up in (5.6) does not actually calculate the transmission losses themselves, but instead it only tells how much RF-power is received at a certain distance d . The SPLM-formula was therefore modified into formula (5.7) in order to calculate the difference between transmitted power and received power, and to construct the actual losses.

$$SPLM = P_t - P_r K \left(\frac{d_0}{d} \right)^\eta \quad (5.7)$$

In the above formulas (5.6) and (5.7), 2 was selected for path loss exponent η , because it best represents the path loss in free space. K in the formula is a unitless constant, which is determined by the antenna characteristics. K can be assumed to be 1, and therefore be left out from the formulas.

The GNU Octave² figure 23 on page 124 represents the relative energy efficiency when comparing the performance of mobile cloud collaboration (*i.e. the best-MT-to-DMC -case*) to round-robin -communications case. Octave-code to generate the figure is listed in appendix A on page 154, and the comments for the code listing can be found at table B on page 156. The code can be executed also on a MATLAB environment.

The Octave-code calculates $E_{savings}$ from formula (5.5) by dividing the summed consumed energies used by the AP when communicating in a round-robin fashion into a (n -sized) MT-cloud with the energy consumed in a correspondingly sized DMC collaboration case (*best-MT-to-DMC -case*), that is, essentially formula (5.4) is divided by formula (5.3), as shown in

2. GNU Octave is a high-level interpreted numerical computation environment and language, quite similar to MATLAB.

formula (5.8).

In the denominator of formula (5.8), the calculation first accounts the MT that is physically closest to the AP and sums that calculation to the $n - 1$ sized cloud (so that there would be equally many MTs in the comparison) of MTs, who all have (for the sake of simplicity) a distance of 10 metres to each other in the Octave code. The formula (5.8) is further broken down into formula (5.9).

$$E_{savings} = \frac{n(RR - SPLM)}{best + (n - 1)(DMC - SPLM)} \quad (5.8)$$

and

$$E_{savings} = \frac{n \left(P_t - P_t \left(\frac{d_0}{d} \right)^\eta \right)}{P_t - P_t \left(\frac{d_0}{d} \right)^\eta + \left(n - 1 \left(P_t - P_t \left(\frac{d_0}{d} \right)^\eta \right) \right)} \quad (5.9)$$

The energy efficiency difference between the formulas (5.3) and (5.4), and furthermore the ratio of (5.9) stems from the fact that the method of DMC communication via the MT who has the best available wireless connection to the AP (*i.e. best-MT-to-DMC* -case) consumes less energy compared to the case when no collaboration is done at all (*i.e. when all MTs independently communicate with the AP*) – as in the round-robin-case.

The "bridge" MT's communication with the DMC takes less overall energy due to the fact that the MTs are all physically relatively closer to each other than to the AP, and they are all fairly close to the "bridge" itself (MT₁ in figure 21 on page 118), and they thus need to use less power for wireless transmissions than in the case of no collaboration at all (*i.e. with direct communications with the AP itself*). DMC-collaboration is more energy efficient than direct communication, despite the extra "bridge" MT between the AP and the rest of the cloud MTs. The slight variance in the figure 23 is due to the randomisation of the selection of the MTs in the cloud. The variance is mitigated by averaging the iterations in the Octave code.

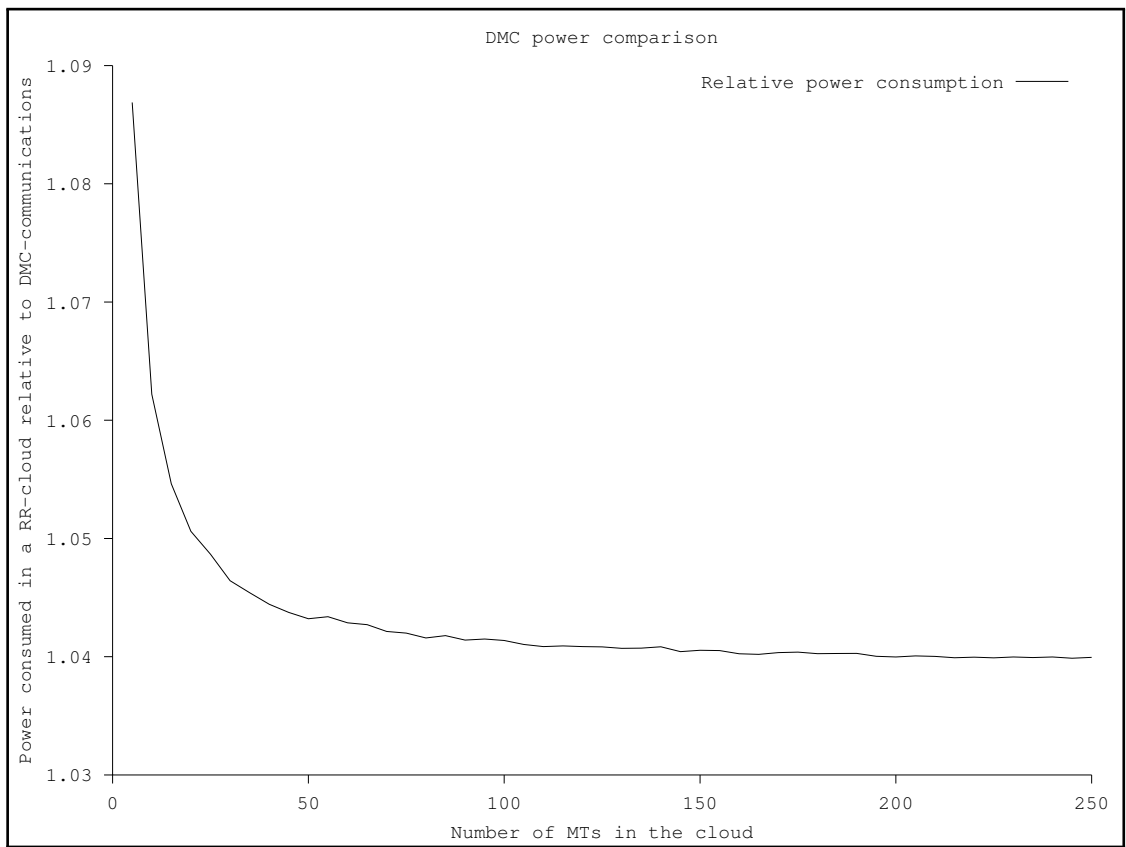

Figure 23. Illustration of the energy efficiency gain from DMC-collaboration.

6 Summary

The aim of this master's thesis was to present some of the most promising or potential modern wireless technologies capable in achieving positive energy savings over the existing methods, and to understand their potential and relations in energy savings. That is to say, the purpose of this thesis was *not* to discuss, cover and explain everything there is to know about wireless energy efficiency, mainly because of the fact that the spectrum of topics covering energy efficiency is so wide, that covering absolutely everything – especially in the form of a master's thesis, would be unpractical.

As the wireless data traffic demand increases, the homogeneous cellular systems are not anymore able to provide uniform throughput throughout the cells without further modernisation – the MTs near the BS can achieve higher data rates more easier than the MTs further away, due to the path-loss and intercell interference from neighbouring macrocells. HetNets are one part of the cure for the poor performance of the indoor MTs, who typically suffer from penetration losses through walls. HetNets are also looking to be one of the next big technology booms for improving the coverage, energy efficiency and throughput of next-generation broadband wireless communication systems.

Femtocells are feasible and affordable alternatives to the more traditional macrocell networks, especially in the rural areas, where the terrestrial network (*e.g. copper wire or fibre optics*) is either too sparse or completely nonexistent. Just like metrocell hotspots, small cells including femtocells, can be deployed where needed to improve local coverage gaps, increase the service capacity and for offloading the traffic from the macrocells to decrease their congestion and transmit power to remote MTs.

HetNets can consist of wireless nodes with different ranges of transmission powers, such as picocells, femtocells, relays, or distributed antennas. As the HetNets are scattered through a macrocell network, lower-power nodes in HetNets can take advantage of the improved spatial reuse. By placing such nodes within the vicinity of dead-spots, coverage problems can be solved with only minimal extra cost to the wireless operator, while the consumers would benefit from improved battery life and faster data rates for mobile Internet. HetNets

can however suffer from intercell interference problems, which is also why efficient inter-cell interference coordination and scheduling mechanisms should be developed to prevent outages and to uniformly distribute the available resources to all MTs in the network (Güvenç et al. 2011, the article also evaluated the performance of inter-cell interference coordination mechanisms).

Wireless devices have their maximum utility when they can be used anywhere and at anytime. Ubiquitous mobility is a key element and a critical factor in the mobile markets. Consumers expect it, and take it also for granted while they are being served more and more features each time a new handset gets announced. This pushes difficult demands for the mobile industry, as they need to make more money with each new customer. As the network grows, so does the energy requirement for it. For the operator to be able to optimise the financial benefit gained from each customer, the energy efficiency of the whole wireless network -chain must be optimal. The energy efficiency has to remain as good as possible in all conditions at all times, both in the pockets of the customers in their handsets, as well as in the network supporting them. For future's wireless networks, handling of the increasing interference from other wireless systems is also a crucial topic.

The improvement in energy efficiency at the wireless interface may be cancelled out by more complex signal processing, increased backhaul traffic, or both, which is why fundamental tradeoffs among these factors need to be studied, found and implemented. Adaptation to the daily and spatial variation of the wireless traffic demand in an efficient way requires careful network management and planning. To summarise roughly, when the wireless transmission channel conditions are good, more data with a higher data rate can be sent over the channel, and conversely, as the wireless channel quality degrades, data rate over the channel slows down.

6.1 Conclusions

The ever-accelerating connection speeds stress the wireless networks and push the network engineers and device manufacturers into developing more and more advanced ways to simultaneously serve the users with more reliable and faster connections, while trying to increase

the energy efficiency by saving power and operating costs wheresoever possible. The accelerating wireless connection speeds with the advances in the mobile applications, and especially in mobile content are the fuel that makes the mobile network advances going. The need for utilising the often congested and limited RF-bands in the most efficient ways possible while simultaneously trying to save electricity, continuously creates newer and more advanced technologies that will eventually benefit all wireless users.

In the future, the wireless network's energy efficiency has got to rise drastically yet again from the previous generation. The energy efficiency jump for the same level of coverage was about 60-fold when going from the legacy 2G systems to LTE (Tombaz, Västberg, and Zander 2011), and nothing less should be anticipated from the upcoming 5G. It can also be expected that the wireless network deployment is going to rise into an even more important role as a research topic.

Bibliography

3GPP. 2013a. ‘3GPP TR 36.814: Evolved Universal Terrestrial Radio Access (E-UTRA); Further advancements for E-UTRA physical layer aspects’. <http://www.3gpp.org/ftp/Specs/html-info/36814.htm>.

———. 2013b. ‘Technical Specification Group Radio Access Network Requirements for Evolved UTRA (E-UTRA) and Evolved UTRAN (E-UTRAN) (Release 9)’. 3GPP. http://www.3gpp.org/ftp/Specs/archive/25_series/25.913/25913-900.zip.

———. 2009a. ‘eNB power saving by changing antenna number’. Huawei. http://www.3gpp.org/ftp/tsg_ran/WG2_RL2/TSGR2_67/docs/R2-094677.zip.

———. 2009b. ‘LTE energy saving solution proposal following discussions at RAN3 65 bis’. Ericsson. Visited on June 21, 2013. http://www.3gpp.org/ftp/tsg_ran/WG3_Iu/TSGR3_66/docs/R3-093103.zip.

———. 2010a. ‘LTE energy saving solution proposal to cell switch off/on’. Huawei. http://www.3gpp.org/ftp/tsg_ran/WG3_Iu/TSGR3_66bis/docs/R3-100163.zip.

———. 2010b. ‘Overview to LTE energy saving solutions to cell switch off/on’. (Valencia, Spain), number 21 (). Visited on June 21, 2013. http://www.3gpp.org/ftp/tsg_ran/WG3_Iu/TSGR3_66bis/docs/R3-100162.zip.

Adhikary, Ansuman, and Giuseppe Caire. 2012. ‘On the coexistence of macrocell spatial multiplexing and cognitive femtocells’. *IEEE International Conference on Communications (ICC)* (): 6830–6834. doi:10.1109/ICC.2012.6364797.

Aghvami, Hamid, Nima Sattari, Oliver Holland, and Paul Pangalos. 2006. ‘Group Handover among Heterogeneous Wireless Networks’. *IEEE MELECON* (): 607–612. doi:10.1109/MELCON.2006.1653174.

Link-level measurements from an 802.11b mesh network. 2004. Volume 34. 4. M.I.T. Computer Science, Artificial Intelligence Laboratory, and Carnegie Mellon University, ACM New York, NY, USA. doi:10.1145/1030194.1015482.

Ahmadi, Sassan. 2011. *WiMAX Technology and Network Evolution*. Edited by Kamran Etemad and Ming-Yee. 87–145. The ComSoc Guides to Communications Technologies. John Wiley / Sons. ISBN: 9780470633014. <http://books.google.fi/books?id=WUMJmTXRmUC>.

Aijaz, Adnan, Hamid Aghvami, and Mojdeh Amani. 2013. ‘A survey on mobile data offloading: technical and business perspectives’. *IEEE Wireless Communications* 20, number 2 (): 104–112. doi:10.1109/MWC.2013.6507401.

Akkari, Nadine, Samir Tohmé, and Mahmoud Doughan. 2007. ‘Vertical-to-Horizontal Handovers: Architecture and Mobility Management’. *IEEE Wireless Communications and Networking Conference* (): 3867–3871. doi:10.1109/WCNC.2007.707.

Akyildiz, Ian F., Xudong Wang, and Weilin Wang. 2005. ‘Wireless mesh networks: a survey’. *Computer Networks* 47, number 4 (): 445–487. doi:10.1016/j.comnet.2004.12.001.

Alcatel-Lucent. 2006. ‘Lucent UMTS Modular Cell Outdoor datasheet’. Visited on April 26, 2013. http://www.alcatel-lucent.com/wps/DocumentStreamerServlet?LMSG_CABINET=Docs_and_Resource_Ctr&LMSG_CONTENT_FILE=Data_Sheets/Lucent_UMTS_Modcell_Outdoor_Product_Datasheet.pdf.

Alexiou, Antonios, Christos Bouras, Vasileios Kokkinos, Konstantinos Kontodimas, and Andreas Papazois. 2011. ‘Interference Behavior of Integrated Femto and Macrocell Environments’. *IFIP Wireless Days* (Niagara Falls, ON, USA) (): 1–5. doi:10.1109/WD.2011.6098161.

Alliance, Wi-Fi. 2005. *WMM Power Save for Mobile and Portable Wi-Fi CERTIFIED Devices*. White paper. Wi-Fi Alliance. http://www.wi-fi.org/sites/default/files/downloads-registered/wp_12_WMM_Power_Save_White_Paper.pdf.

- Alonso-Zárate, Jesus, E. Kartsakli, Ch. Verikoukis, and L. Alonso. 2008. 'Persistent RC-SMA: A MAC Protocol for a Distributed Cooperative ARQ Scheme in Wireless Networks'. *EURASIP Journal on Advances in Signal Processing* 2008, number 817401 (): 1–13. doi:10.1155/2008/817401.
- Altera. 2011. 'Smart Antennas – Beamforming'. Visited on May 2, 2013. <http://www.altera.com/end-markets/wireless/advanced-dsp/beamforming/wir-beamforming.html>.
- Using mobile agents in real world: A survey and evaluation of agent platforms*. 2001. ACM Press. <http://tiny.cc/uzlz0w>.
- Arokiamary, V.J. 2009. *Cellular And Mobile Communications*. 1st edition. Technical Publications. ISBN: 9788184315851. <http://books.google.fi/books?id=OnDGBzMRcbwC>.
- Auer, Gunther, Vito Giannini, Claude Desset, István Gódor, Per Skillermark, Magnus Olsson, Muhammad Ali Imran, et al. 2011. 'How much energy is needed to run a wireless network?' *IEEE Wireless Communications* 18, number 5 (): 40–49. doi:10.1109/MWC.2011.6056691.
- Auer, Gunther, István Gódor, László Hévízi, Muhammad Ali Imran, Jens Malmudin, Péter Fazekas, Gergely Biczók, et al. 2010. 'Enablers for Energy Efficient Wireless Networks'. *IEEE Vehicular Technology Conference, Invited Paper* (): 1–5. doi:10.1109/VETEFC.2010.5594386.
- Proposed Routing for IEEE 802.11s WLAN Mesh Networks*. 2006. 5. ACM New York, NY, USA. doi:10.1145/1234161.1234166.
- Baldemair, Robert, Erik Dahlman, Gabor Fodor, Gunnar Mildh, Stefan Parkvall, Yngve Selén, Hugo Tullberg, and Kumar Balachandran. 2013. 'Evolving Wireless Communications: Addressing the Challenges and Expectations of the Future'. *IEEE Vehicular Technology Magazine* 8, number 1 (): 24–30. doi:10.1109/MVT.2012.2234051.
- Bathich, Ammar A., Mohd Dani Baba, and Muhammad Ibrahim. 2012. 'IEEE 802.21 based vertical handover in WiFi and WiMAX networks'. *IEEE Symposium on Computers and Informatics* (): 140–144. doi:10.1109/ISCI.2012.6222682.

- Belady, Christian, Andy Rawson, John Pfleuger, and Tahir Cader. 2008. *Green Grid Data Center Power Efficiency Metrics: PUE and Dcie*. http://www.thegreengrid.org/~media/WhitePapers/White_Paper_6_-_PUE_and_DCiE_Eff_Metrics_30_December_2008.pdf.
- Benyamina, Djohara, Abdelhakim Hafid, and Michel Gendreau. 2012. 'Wireless Mesh Networks Design - A Survey'. *IEEE Communications Surveys & Tutorials* 14, number 2 (): 299–310. doi:10.1109/SURV.2011.042711.00007.
- Betz, Sharon M., and Vincent Poor. 2008. 'Energy Efficient Communications in CDMA Networks: A Game Theoretic Analysis Considering Operating Costs'. *IEEE Transactions on Signal Processing* 56, number 10 (): 5181–5190. doi:10.1109/TSP.2008.929118.
- BMW, DaimlerChrysler, Ford, GM, Nissan, Toyota, and VW. 2005. *Vehicle Safety Communications Project Task 3 Final Report*. Technical Report DOT HS 809 859. CAMP, 39255 Country Club Drive, Suite B-30, Farmington Hills, MI 48331, USA: U.S. DoT, NHTSA. http://www.its.dot.gov/research_docs/pdf/59vehicle-safety.pdf.
- Bobed, Carlos, Sergio Ilarri, and Eduardo Mena. 2010. 'Distributed Mobile Computing: Development of Distributed Applications Using Mobile Agents'. *Proceedings of the International Conference on Parallel and Distributed Processing Techniques and Applications* (Zaragoza, Spain) (): 562–568.
- Bontu, Chandra S., and Ed Illidge. 2009. 'DRX mechanism for power saving in LTE'. *IEEE Communications Magazine* 47, number 6 (): 48–55. doi:10.1109/MCOM.2009.5116800.
- Borkar, Shekhar. 1999. 'Design Challenges of Technology Scaling'. *IEEE Micro* 19, number 4 (): 23–29. doi:10.1109/40.782564.
- Cai, Lin X., H. Vincent Poor, Yongkang Liu, Tom H. Luan, Xuemin Shen, and Jon W. Mark. 2011. 'Dimensioning Network Deployment and Resource Management in Green Mesh Networks'. *IEEE Wireless Communications* 18, number 5 (): 58–65. doi:10.1109/MWC.2011.6056693.

- Cannons, Jillian, Laurence B. Milstein, and Kenneth Zeger. 2009. 'An Algorithm for Wireless Relay Placement'. *IEEE Transactions on Wireless Communications* 8, number 11 (): 5564–5574. doi:10.1109/TWC.2009.081036.
- Cao, Dongxu, Sheng Zhou, Chao Zhang, and Zhisheng Niu. 2010. 'Energy Saving Performance Comparison of Coordinated Multi-Point Transmission and Wireless Relaying'. *IEEE Global Telecommunications Conference* (): 1–5. doi:10.1109/GLOCOM.2010.5683653.
- Carr, Joseph J. 2001. *Practical Antenna Handbook*. 4th edition. Edited by Scott L. Grillo. 609. The McGraw-Hill Companies, Inc. ISBN: 0071374353, 9780071374354. doi:10.1036/0071389318.
- CATRENE-Programme. 2013. 'PANAMA'. [http://www.catrene.org/web/downloads/profiles_catrene/CA101-PANAMA-project%20profile-final%20\(7-6-11\).pdf](http://www.catrene.org/web/downloads/profiles_catrene/CA101-PANAMA-project%20profile-final%20(7-6-11).pdf).
- Celtic-Plus. 2013. 'OPERA-Net'. <http://www.celtic-initiative.org/Projects/Celtic-projects/Call5/OPERA-Net/operanet-default.asp>.
- Chambers, David. 2008. 'What's the difference between picocells and femtocells?' Visited on April 26, 2013. <http://www.thinksmallcell.com/FAQs/whats-the-difference-between-picocells-and-femtocells.html>.
- Chandrasekhar, Vikram, and Jeffrey G. Andrews. 2007. 'Uplink Capacity and Interference Avoidance for Two-Tier Cellular Networks'. *IEEE Global Telecommunications Conference* (): 3322–3326. doi:10.1109/GLOCOM.2007.630.
- Chang, Zheng, and Tapani Ristaniemi. 2012. 'Reducing Energy Consumption via Cooperative OFDMA Mobile Clusters'. *IEEE 17th International Workshop on Computer Aided Modeling and Design of Communication Links and Networks* (): 162–164. doi:10.1109/CAMAD.2012.6335321.
- . 2013. 'Energy Efficiency of Collaborative OFDMA Mobile Clusters'. *IEEE Consumer Communications and Networking Conference* (): 74–78. doi:10.1109/CCNC.2013.6488428.

- Chen, Tao, Yang Yang, Honggang Zhang, Haesik Kim, and Kari Horneman. 2011. 'Network energy saving technologies for green wireless access networks'. *IEEE Wireless Communications* 18, number 5 (): 30–38. doi:10.1109/MWC.2011.6056690.
- The Impact of Channel Variations on Wireless Distributed Computing Networks*. 2009. Blacksburg, VA, USA. doi:10.1109/GLOCOM.2009.5425441.
- Cheng, Peng, Chen-Nee Chuah, and Xin Liu. 2004. 'Energy-aware node placement in wireless sensor networks'. *IEEE Global Telecommunications Conference* (Davis, CA, USA) 5 (): 3210–3214. doi:10.1109/GLOCOM.2004.1378943.
- Chiang, Mung, Prashanth Hande, Tian Lan, and Chee Wei Tan. 2008. *Power Control in Wireless Cellular Networks Foundation and Trends in sample*. Edited by Anthony Ephremides and Francois Baccelli. now Publishers Inc. ISBN: 1-933019-09-3.
- Chiaraviglio, Luca, Delia Ciullo, Michela Meo, and Marco Ajmone Marsan. 2008. 'Energy-Aware UMTS Access Networks'. *The 11th International Symposium on Wireless Personal Multimedia Communications* (Saariselkä, Finland) (): 1–5.
- Chinthaka, H., N. Premachandra, Tomohiro Yendo, Mehrdad Panahpour Tehrani, Takaya Yamazato, Hiraku Okada, Toshiaki Fujii, and Masayuki Tanimoto. 2010. 'High-speed-camera Image Processing Based LED Traffic Light Detection for Road-to-vehicle Visible Light Communication'. *IEEE Intelligent Vehicles Symposium* (): 793–798. doi:10.1109/IVS.2010.5548097.
- Chou, H.-H., T.D. Wilkinson, N. Collings, W.A. Crossland, and H.-T. Chou. 2010. 'Implementation of coarse wavelength division multiplexing multi-wavelength routing switch core for storage area networks'. *IET Optoelectronics* 4, number 2 (): 64–77. doi:10.1049/iet-opt.2009.0044.
- Chu, Feng-Seng, Kwang-Cheng Chen, and Gerhard Fettweis. 2012. 'Green Resource Allocation to Minimize Receiving Energy in OFDMA Cellular Systems'. *IEEE Communications Letters* 16, number 3 (): 372–374. doi:10.1109/LCOMM.2012.010512.2339.
- EHF for Satellite Communications: The New Broadband Frontier*. 2011. Volume 99. 11. doi:10.1109/JPROC.2011.2158765.

- Claussen, Holger, Lester T. W. HO, and Florian Pivit. 2008. 'Effects of joint macrocell and residential picocell deployment on the network energy efficiency'. *IEEE 19th International Symposium on Personal, Indoor and Mobile Radio Communications* (): 1–6. doi:10.1109/PIMRC.2008.4699844.
- Claussen, Holger, Lester T. W. Ho, and Louis G. Samuel. 2008. 'Self-optimization of coverage for femtocell deployments'. *Wireless Telecommunications Symposium* (): 278–285. doi:10.1109/WTS.2008.4547576.
- Conte, Alberto, Afef Feki, Luca Chiaraviglio, Delia Ciullo, Michela Meo, and Marco Ajmone Marsan. 2011. 'Cell Wilting and Blossoming for Energy Efficiency'. *IEEE Wireless Communications* 18, number 5 (): 50–57. doi:10.1109/MWC.2011.6056692.
- Cordeiro, Carlos, Kiran Challapali, Dagnachew Birru, and Sai Shankar. 2005. 'IEEE 802.22: The First Worldwide Wireless Standard based on Cognitive Radios'. *First IEEE International Symposium on New Frontiers in Dynamic Spectrum Access Networks* (): 328–337. doi:10.1109/DYSPAN.2005.1542649.
- Correia, Luis M., Dietrich Zeller, Oliver Blume, Dieter Ferling, Ylva Jading, István Gódor, Gunther Auer, and Liesbet Van der Perre. 2010. 'Challenges and enabling technologies for energy aware mobile radio networks'. *IEEE Communications Magazine* 48, number 11 (): 66–72. doi:10.1109/MCOM.2010.5621969.
- Cui, Kaiyun, Gang Chen, Zhengyuan Xu, and Richard D. Roberts. 2010. 'Line-of-sight visible light communication system design and demonstration'. In *7th International Symposium on Communication Systems Networks and Digital Signal Processing*, 621–625.
- Cui, Qimei, Bing Luo, and Xueqing Huang. 2011. 'Joint Power Allocation Solutions for Power Consumption Minimization in Coordinated Transmission System'. *IEEE GLOBECOM Workshops (Beijing, China)* (): 452–457. doi:10.1109/GLOCOMW.2011.6162490.
- Dana George Reed, KD1CW, editor. 2002. *The ARRL Handbook For Radio Amateurs*. 79th edition. Newington, CT 06111, USA: ARRL - the national association for Amateur Radio. ISBN: 0-87259-189-1.

- Datla, Dinesh, Xuetao Chen, Timothy R. Newman, Jeffrey H. Reed, and Tamal Bose. 2009. 'Power Efficiency in Wireless Network Distributed Computing'. *IEEE 70th Vehicular Technology Conference* (Blacksburg, VA, USA) (): 1–5. doi:10.1109/VETECONF.2009.5379026.
- Datla, Dinesh, Xuetao Chen, Thomas Tsou, Sahana Raghunandan, S. M. Shajedul Hasan, Jeffrey H. Reed, Carl B. Dietrich, Tamal Bose, Bruce Fette, and Jeong-Ho Kim. 2012. 'Wireless Distributed Computing A Survey of Research Challenges'. *IEEE Communications Magazine* 50, number 1 (): 144–152. doi:10.1109/MCOM.2012.6122545.
- Datla, Dinesh, Haris I. Volos, S.M. Hasan, Jeffrey H. Reed, and Tamal Bose. 2012. 'Wireless distributed computing in cognitive radio networks'. *Ad Hoc Networks* (Wireless @ Virginia Tech, Blacksburg, VA 24061, United States) 10, number 5 (): 845–857. doi:10.1016/j.adhoc.2011.04.002.
- Energy-Scalable OFDM Transmitter Design and Control*. 2006. Kapeldreef 75, B-3001 Leuven, Belgium: IMEC, ACM New York, NY, USA. doi:10.1145/1146909.1147050.
- Deqiang, Ding, Ke Xizheng, and Xu Linpeng. 2007. 'An Optimal Lights Layout Scheme for Visible Light Communication System'. *8th International Conference on Electronic Measurement and Instruments* (): 2189–2194. doi:10.1109/ICEMI.2007.4350650.
- Devroye, Natasha, Patrick Mitran, and Vahid Tarokh. 2006. 'Achievable rates in cognitive radio channels'. *IEEE Transactions on Information Theory* 52, number 5 (): 1813–1827. doi:10.1109/TIT.2006.872971.
- Devroye, Natasha, Mai Vu, and Vahid Tarokh. 2008. 'Cognitive radio networks'. *IEEE Signal Processing Magazine* 25, number 6 (): 12–23. doi:10.1109/MSP.2008.929286.
- Routing in Multi-Radio, Multi-Hop Wireless Mesh Networks*. 2004. Microsoft Research, ACM New York, NY, USA. doi:10.1145/1023720.1023732.
- EARTH-Project. 2010. 'Earth poster'. Visited on April 26, 2013. https://www.ict-earth.eu/news/2010/02-24_EARTH-Poster_ICT4EE.pdf.
- Optimal control for base station sleep mode in energy efficient radio access networks*. 2011. Orange Labs, Institut Telecom, and Telecom SudParis. doi:10.1109/INFCOM.2011.5934881.

- Elbahhar, F., A. Rivenq, M. Heddebaut, and J.M. Rouvaen. 2005. 'Using UWB Gaussian pulses for intervehicle communications'. *IEEE Proceedings Communications* 15, number 2 (): 229–234. doi:10.1049/ip-com:20040572.
- Etoh, Minoru, Tomoyuki Ohya, and Yuji Nakayama. 2008. 'Energy Consumption Issues on Mobile Network Systems'. *International Symposium on Applications and the Internet* (): 365–368. doi:10.1109/SAINT.2008.84.
- Feng, Jing, Che-Wei Chang, Serkan Sayilir, Yung-Hsiang Lu, Byunghoo Jung, Dimitrios Peroulis, and Y. Charlie Hu. 2010. 'Energy-Efficient Transmission for Beamforming in Wireless Sensor Networks'. *Energy-Efficient Transmission for Beamforming in Wireless Sensor Networks* (): 1–9. doi:10.1109/SECON.2010.5508256.
- Feng, Jing, Yung-Hsiang Lu, Byunghoo Jung, and Dimitrios Peroulis. 2009. 'Energy efficient collaborative beamforming in wireless sensor networks'. *Energy efficient collaborative beamforming in wireless sensor networks*, IEEE International Symposium on Circuits and Systems (): 2161–2164. doi:10.1109/ISCAS.2009.5118224.
- Ferling, Dieter, Thomas Bohn, Dietrich Zeller, Pål Frenger, István Gódor, Ylva Jading, and William Tomaselli. 2010. 'Energy Efficiency Approaches for Radio Nodes'. *Future Network and Mobile Summit (Florence)* (): 1–9. <http://www.futurenetworksummit.eu/2010/>.
- Fitzek, Frank H.P., Janus Heide, Morten V. Pedersen, Gergö Ertli, and Marcos Katz. 2011. 'Multi-Hop versus Overlay Networks A Realistic Comparison Based on Energy Requirements and Latency'. *IEEE 73rd Vehicular Technology Conference (Yokohama, Japan)* (): 1–5. doi:10.1109/VETECS.2011.5956533.
- Gao, Lin, George Iosifidis, Jianwei Huang, and Leandros Tassiulas. 2013. 'Economics of mobile data offloading'. *IEEE Conference on Computer Communications Workshops* (): 351–356. doi:10.1109/INFCOMW.2013.6562887.
- Gesbert, David, Stephen Hanly, Howard Huang, Shlomo Shamai Shitz, Osvaldo Simeone, and Wei Yu. 2010. 'Multi-Cell MIMO Cooperative Networks: A New Look at Interference'. *IEEE Journal on Selected Areas in Communications* 28, number 9 (): 1380–1408. doi:10.1109/JSAC.2010.101202.

- Gheryani, Mabruk, Zhiyuan Wu, and Yousef R. Shayan. 2009. 'Multi-Dimensional Beamforming for Adaptive MIMO Systems'. *4th International Symposium on Wireless Pervasive Computing* (): 1–2. doi:10.1109/ISWPC.2009.4800596.
- Giustiniano, Domenico, Nils Ole Tippenhauer, and Stefan Mangold. 2012. 'Low complexity Visible Light Networking with LED-to-LED communication'. *IFIP Wireless Days* (Zürich, Switzerland) (): 1–8. doi:10.1109/WD.2012.6402861.
- Gohil, Asvin, Hardik Modi, and Shobhit K Patel. 2013. '5G technology of mobile communication: A survey'. *International Conference on Intelligent Systems and Signal Processing* (): 288–292. doi:10.1109/ISSP.2013.6526920.
- Goldsmith, Andrea. 2005. *Wireless Communications*. Cambridge University Press. ISBN: 9780521837163. <http://books.google.fi/books?id=n-3ZZ9i0s-cC>.
- Gong, Jie, Sheng Zhou, Zhisheng Niu, and Peng Yang. 2010. 'Traffic-aware base station sleeping in dense cellular networks'. *18th International Workshop on Quality of Service* (Beijing) (): 1–2. doi:10.1109/IWQoS.2010.5542725.
- Grauballe, Anders, Ben Krøyer, Andreas Häber, Christian S. Jensen, Antti Saukko, Clemens Gühmann, Eero Penttinen, et al. 2007. *Mobile Phone Programming and its Application to Wireless Networking*. Edited by Frank H.P. Fitzek and Frank Reichert. Springer. ISBN: 978-1-4020-5969-8.
- Greenstein, Larry J., Noach Amitay, Ta-Shing Chu, Leonard J. Cimini Jr, Gerard J. Foschini, Michael J. Gans, Chih-Lin I, A. J. Rustako Jr, Reinaldo A. Valenzuela, and Giovanni Vannucci. 1992. 'Microcells in personal communications systems'. *IEEE Communications Magazine* 30, number 12 (): 76–88. doi:10.1109/35.210359.
- Griesbach, Jacob D., and Gerald Benitz. 2013. 'Adaptive Beamforming Techniques for Side-lobe Control and Mitigation of Nonstationary Interference'. http://www.ll.mit.edu/asap/asap_05/pdf/Presentations/26_griesbach_P.pdf.
- Group, The Climate. 2008. *SMART 2020: Enabling the low carbon economy in the information age*. Visited on July 1, 2013. http://www.smart2020.org/_assets/files/03_Smart2020Report_lo_res.pdf.

Grubb, Michael. 2003. 'The Economics of the Kyoto Protocol'. *World Economics* 4, number 3 (): 143–189. <http://www.econ.cam.ac.uk/rstaff/grubb/publications/J36.pdf>.

Gruber, Markus, Oliver Blume, Dieter Ferling, Dietrich Zeller, Muhammad Ali Imran, and Emilio Calvanese Strinati. 2009. 'EARTH – Energy Aware Radio and Network Technologies'. *IEEE 20th International Symposium on Personal, Indoor and Mobile Radio Communications* (Tokyo, Japan) (): 1–5. doi:10.1109/PIMRC.2009.5449938.

Güvenç, İsmail, Moo-Ryong Jeong, İbrahim Demirdoğen, Balkan Kecicioğlu, and Fujio Watanabe. 2011. 'Range Expansion and Inter-Cell Interference Coordination (ICIC) for Picocell Networks'. *IEEE Vehicular Technology Conference* (): 1–6. doi:10.1109/VETEFC.2011.6092863.

Haas, Jon, Mark Monroe, John Pflueger, Jack Pouchet, Peter Snelling, Andy Rawson, and Freeman Rawson. 2009. *Proxy Proposals for Measuring Data Center Productivity*. <http://www.thegreengrid.org/~media/WhitePapers/White%20Paper%2017%20-%20Proxies%20Proposals%20for%20Measuring%20Data%20Center%20Efficiencyv2.pdf>.

Han, Seung Hee, and Jae Hong Lee. 2005. 'An overview of peak-to-average power ratio reduction techniques for multicarrier transmission'. *IEEE Wireless Communications* 12, number 2 (): 56–65. doi:10.1109/MWC.2005.1421929.

Microwave capacity evolution. 2011. 1:1–6. <http://www.ericsson.com/res/docs/review/Microwave-Capacity-Evolution.pdf>.

Visible light communication using sustainable LED lights. 2013. Kyoto, Japan. ISBN: 978-1-4673-4676-4.

Hassibi, Babak, and Bertrand M. Hochwald. 2003. 'How much training is needed in multiple-antenna wireless links?' *IEEE Transactions on Information Theory* 49, number 4 (): 951–963. doi:10.1109/TIT.2003.809594.

Haynes, Toby. 1998. 'A Primer on Digital Beamforming'. *Spectrum Signal Processing*:15. http://www.spectrumsignal.com/publications/beamform_primer.pdf.

He, An, Ashwin Amanna, Thomas Tsou, Xuetao Chen, Dinesh Datla, Joseph Gaeddert, Timothy R. Newman, et al. 2011. 'Green Communications: A Call for Power Efficient Wireless Systems'. *Journal of Communications* (Blacksburg, VA, USA) 6, number 4 (): 340–351. doi:10.4304/jcm.6.4.340–351.

Ho, Lester T. W., and Holger Claussen. 2007. 'Effects of User-Deployed, Co-Channel Femtocells on the Call Drop Probability in a Residential Scenario'. *IEEE 18th International Symposium on Personal, Indoor and Mobile Radio Communications* (): 1–5. doi:10.1109/PIMRC.2007.4394281.

Hou, Y. Thomas, Yi Shi, Hanif D. Sherali, and Scott F. Midkiff. 2005. 'On energy provisioning and relay node placement for wireless sensor networks'. *IEEE Transactions on Wireless Communications* 4, number 5 (): 2579–2590. doi:10.1109/TWC.2005.853969.

On the Scalability of IEEE 802.11 Ad Hoc Networks. 2002. The Ohio State University, Department of Computer and Information Science, ACM New York, NY, USA. doi:10.1145/513800.513822.

Huawei Technologies Co., Ltd. 2013. 'Huawei Whitepaper on Energy Efficiency and Carbon Reduction'. <http://www.huawei.com/en/static/hw-076768.pdf>.

Hyun-Seung, Kim, Kim Deok-Rae, Yang Se-Hoon, and Son Yong-Hwan. 2011. 'Intercell interference mitigation and indoor positioning system based on carrier allocation visible light communication'. *5th International Conference on Signal Processing and Communication Systems* (): 1–7. doi:10.1109/ICSPCS.2011.6140854.

IEEE. 2013. 'IEEE P802.11 Wireless LANs HWMP Specification'. <https://mentor.ieee.org/802.11/dcn/06/11-06-1778-01-000s-hwmp-specification.doc>.

IEEE. 2009. *802.16j-2009 - IEEE Standard for Local and metropolitan area networks Part 16: Air Interface for Broadband Wireless Access Systems Amendment 1: Multihop Relay Specification*. 1–290. doi:10.1109/IEEESTD.2009.5167148.

Spot-diffusing and fly-eye receivers for indoor infrared wireless communications. 1992. Vancouver, BC, Canada: Department of Electrical Engineering, University of Ottawa. doi:10.1109/ICWC.1992.200761.

IEEE-P802.11-TGad. 2013. ‘Status of Project IEEE 802.11ad’. http://www.ieee802.org/11/Reports/tgad_update.htm.

IETF. 2013. ‘Ad hoc On-Demand Distance Vector (AODV) Routing’. <https://www.ietf.org/rfc/rfc3561.txt>.

Imran, Ashraf, Federico Boccardi, and Lester Ho. 2011. ‘SLEEP mode techniques for small cell deployments’. *IEEE Communications Magazine* 49, number 8 (): 72–79. doi:10.1109/MCOM.2011.5978418.

IMT2000-Project. 2002. ‘What is IMT-2000’. Visited on April 26, 2013. http://www.itu.int/osg/imt-project/docs/What_is_IMT2000.ppt.

Intarapanich, Apichart, Robert J.Davies, Abu B. Sesay, and Padam L. Kafle. 2004. ‘The capacity of multiantenna array system in microcell and picocell wireless environment’. *Canadian Conference on Electrical and Computer Engineering* 2 (): 797–800. doi:10.1109/CCECE.2004.1345234.

‘Considerations of horizontal handover and vertical handover’. 2007. International Telecommunication Union. http://www.itu.int/md/dologin_md.asp?id=T05-SG19-C-0025!!MSW-E.

ip.access. 2013a. ‘Consumer small cell’. <http://www.ipaccess.com/en/consumer-femtocell>.

———. 2013b. ‘nanoGSM-picocell’. <http://www.ipaccess.com/en/nanoGSM-picocell>.

Ismail, Muhammad, and Weihua Zhuang. 2011. 'Network Cooperation for Energy Saving in Green Radio Communications'. *IEEE Wireless Communications* 18, number 5 (): 76–81. doi:10.1109/MWC.2011.6056695.

ITU. 2013. 'What really is a Third Generation 3G Mobile Technology'. http://www.itu.int/ITU-D/tech/FORMER_PAGE_IMT2000/DocumentsIMT2000/What_really_3G.pdf.

———. 2011. '3G-definition'. Visited on April 4, 2011. <http://www.itu.int/osg/spu/imt-2000/technology.html>.

Iwasaki, Shinya, Chinthaka Premachandra, Tomohiro Endo, Toshiaki Fujii, Masayuki Tanimoto, and Yoshikatsu Kimura. 2008. 'Visible light road-to-vehicle communication using highspeed camera'. *IEEE Intelligent Vehicles Symposium* (): 13–18. doi:10.1109/IVS.2008.4621155.

Jain, Kamal, Jitendra Padhye, Venkata N. Padmanabhan, and Lili Qiu. 2005. 'Impact of Interference on Multi-Hop Wireless Network Performance'. *Wireless Networks - Special issue: Selected papers from ACM MobiCom 2003* 11, number 4 (): 471–487. doi:10.1007/s11276-005-1769-9.

Janevski, Toni. 2009. '5G Mobile Phone Concept'. *6th IEEE Consumer Communications and Networking Conference, CCNC 2009* (): 1–2. doi:10.1109/CCNC.2009.4784727.

Jardosh, Amit P., Konstantina Papagiannaki, Elizabeth M. Belding, Kevin C. Almeroth, Gianluca Iannaccone, and Bapi Vinnakota. 2009. 'Green WLANs: On-Demand WLAN Infrastructures'. *Mobile Networks and Applications* 14, number 6 (): 798–814. doi:10.1007/s11036-008-0123-8.

Jiang, Yibo, Jilei Hou, Arjun Bharadwaj, and Sharad Sambhwani. 2012. 'Design aspects of closed loop beamforming transmit diversity in HSUPA'. *IEEE International Conference on Communications* (): 6061–6065. doi:10.1109/ICC.2012.6364790.

Kahn, Joseph M., Roy You, Pouyan Djahani, Amy G. Weisbin, Beh Kian Teik, and Andrew Tang. 2002. 'Imaging diversity receivers for high-speed infrared wireless communication'. *IEEE Communications Magazine* 36, number 12 (): 88–94. doi:10.1109/35.735884.

Al-Kanj, Lina, and Zaher Dawy. 2012. 'Optimized Energy-Aware Multicasting over Wireless Cellular Networks with Multihop Cooperation'. *IEEE International Conference on Communications (ICC)* (): 5243–5248. doi:10.1109/ICC.2012.6363939.

Experimental investigation of multipath richness for multi-element transmit and receive antenna arrays. 2000. Volume 3. Aalborg University, Fr. Bajersvej 7A-5, DK-9220 Aalborg, Denmark: Center for Person Kommunikation. doi:10.1109/VETECS.2000.851623.

Kermoal, Jean Philippe, Laurent Schumacher, Frank Frederiksen, and Preben E. Mogensen. 2001. 'Polarization diversity in MIMO radio channels: Experimental validation of a stochastic model and performance assessment'. *IEEE 54th Vehicular Technology Conference* 1:22–26. doi:10.1109/VTC.2001.956547.

Khan, Farooq, Zhouyue Pi, and Sridhar Rajagopal. 2012. 'Millimeter-wave Mobile Broadband with Large Scale Spatial Processing for 5G Mobile Communication'. *50th Annual Allerton Conference on Communication, Control, and Computing* (Allerton House, UIUC, Illinois, USA) (): 1517–1523. doi:10.1109/Allerton.2012.6483399.

Kim, Deok-Rae, Se-Hoon Yang, Hyun-Seung Kim, Yong-Hwan Son, and Sang-Kook Han. 2012. 'Outdoor Visible Light Communication for inter vehicle communication using Controller Area Network'. *Fourth International Conference on Communications and Electronics* (): 31–34. doi:10.1109/CCE.2012.6315865.

Kim, H., X. Yang, and M. Venkatachalam. 2011. 'Dual access points association in relay networks to conserve mobile terminals' energy'. *IET Communications* 5, number 18 (): 2598–2605. doi:10.1049/iet-com.2011.0103.

Kim, Hongseok, and Gustavo de Veciana. 2010. 'Leveraging Dynamic Spare Capacity in Wireless Systems to Conserve Mobile Terminals' Energy'. *IEEE/ACM Transactions on networking* 18, number 3 (): 802–815. doi:10.1109/TNET.2009.2032238.

Kolios, Panayiotis, Vasilis Friderikos, and Katerina Papadaki. 2010. 'Switching off low utilization base stations via store carry and forward relaying'. *IEEE 21st International Symposium on Personal, Indoor and Mobile Radio Communications Workshops* (): 312–316. doi:10.1109/PIMRCW.2010.5670385.

Komine, Toshihiko, and Masao Nakagawa. 2004. 'Fundamental analysis for visible-light communication system using LED lights'. *IEEE Transactions on Consumer Electronics* 50, number 1 (): 100–107. doi:10.1109/TCE.2004.1277847.

Study of visible light communication system using RGB LED lights. 2011. Tokyo, Japan: Waseda University, Hosei University, and Seikei University. ISBN: 978-1-4577-0714-8.

Kumar, Ramesh. 2013. 'A picocell primer'. http://www.eetimes.com/document.asp?doc_id=1273406.

Kumar, Vijay. 2006. *Mobile Database Systems*. University of Missouri, KC, USA: John Wiley / Sons. ISBN: 9780470048283. <http://books.google.fi/books?id=ULmg1grduBMC>.

LaDuca, Robert J., Joseph J. Sharkey, and Dmitry V. Ponomarev. 2008. 'Hiding Communication Delays in Clustered Microarchitectures'. *20th International Symposium on Computer Architecture and High Performance Computing (Campo Grande, MS) ()*: 107–114. doi:10.1109/SBACPAD.2008.30.

Lange, Danny B., and Mitsuru Oshima. 1999. 'Seven good reasons for mobile agents'. Edited by Diane Crawford. *Communications of the ACM* (New York, NY, USA) 42, number 3 (): 88–89. doi:10.1145/295685.298136.

Laselva, Daniela, Francesco Capozzi, Frank Frederiksen, Klaus I. Pedersen, Jeroen Wigard, and István Z. Kovács. 2009. 'On the impact of realistic control channel constraints on QOS provisioning in UTRAN LTE'. *IEEE Vehicular Technology Conference ()*: 1–5. doi:10.1109/VETEFC.2009.5378830.

Lee, Kyunghan, Joohyun Lee, Yung Yi, Injong Rhee, and Song Chong. 2013. 'Mobile Data Offloading: How Much Can WiFi Deliver?' *IEEE/ACM Transactions on Networking* 21, number 2 (): 536–550. doi:10.1109/TNET.2012.2218122.

Li, Hao, Bo Zhang, and Yong Fan. 2012. 'A Terahertz Frequency Tripler with Single Serial Varactor Diode'. *International Workshop on Microwave and Millimeter Wave Circuits and System Technology ()*: 1–4. doi:10.1109/MMWCST.2012.6238137.

Li, Xichun, Rosli Salleh, Abdulla Aani, and Omar Zakaria. 2009. 'Multi-network Data Path for 5G Mobile Multimedia'. *International Conference on Communication Software and Networks* (): 583–587. doi:10.1109/ICCSN.2009.107.

Energy-Efficient Task Scheduling Algorithm for Mobile Terminal. 2006. College of Computer Science GuangZhou, China: South China University of Technology. ISBN: 0-86341-644-6.

Lin, Bin, Pin-Han Ho, Liang-Liang Xie, Xuemin (Sherman) Shen, and János Tapolcai. 2010. 'Optimal Relay Station Placement in Broadband Wireless Access Networks'. *IEEE Transactions on Mobile Computing* 9, number 2 (): 259–269. doi:10.1109/TMC.2009.114.

Lin, Phone, Wei-Ru Lai, and Chai-Hien Gan. 2004. 'Modeling opportunity driven multiple access in UMTS'. *IEEE Transactions on Wireless Communications* 3, number 5 (): 1669–1677. doi:10.1109/TWC.2004.833446.

Enabling Vehicular Visible Light Communication (V²LC) Networks. 2011. Las Vegas, Nevada, USA: Rice University and Intel Labs, ACM New York, NY, USA. doi:10.1145/2030698.2030705.

Framework and access technology for integration between WLAN and B3G. 2006. ICWMMN2006 Proceedings. Beijing 100044, P. R. China: Modern Telecommunications Institute, Beijing JiaoTong University. ISBN: 0-86341-644-6.

López-Pérez, David, Guillaume de la Roche, Alvaro Valcarce, Alpár Jüttner, and Jie Zhang. 2008. 'Interference avoidance and dynamic frequency planning for WiMAX femtocells networks'. *11th IEEE Singapore International Conference on Communication Systems* (): 1579–1584. doi:10.1109/ICCS.2008.4737449.

Luo, Bing, Qimei Cui, Hui Wang, and Xiaofeng Tao. 2010. 'Optimal Joint Water-filling for OFDM Systems with Multiple Cooperative Power Sources'. *IEEE Global Telecommunications Conference (Beijing, China)* (): 1–5. doi:10.1109/GLOCOM.2010.5683971.

Maiberger, Roy, Doron Ezri, and Michael Erlihson. 2010. 'Location based beamforming'. *IEEE 26th Convention of Electrical and Electronics Engineers in Israel* (): 184–187. doi:10.1109/EEEI.2010.5661954.

Marcus, Michael J. 2005. 'Unlicensed cognitive sharing of TV spectrum: the controversy at the Federal Communications Commission'. *IEEE Communications Magazine* 43, number 5 (): 24–25. doi:10.1109/MCOM.2005.1453413.

Marsan, Marco Ajmone, Luca Chiaraviglio, Delia Ciullo, and Michela Meo. 2009. 'Optimal Energy Savings in Cellular Access Networks'. *IEEE International Conference on Communications Workshops (Dresden)* (): 1–5. doi:10.1109/ICCW.2009.5208045.

Marsan, Marco Ajmone, and Michela Meo. 2010. 'Energy Efficient Management of two Cellular Access Networks'. *ACM SIGMETRICS Performance Evaluation Review newsletter* 37, number 4 (): 69–73. doi:10.1145/1773394.1773406.

Martin, Carol C., Jack H. Winters, and Nelson R. Sollenberger. 2000. 'Multiple-input multiple-output (MIMO) radio channel measurements'. *IEEE 52nd Vehicular Technology Conference* 2 (): 774–779. doi:10.1109/VETECF.2000.887110.

———. 2001. 'MIMO radio channel measurements: performance comparison of antenna configurations'. *IEEE VTS 54th Vehicular Technology Conference* 2 (): 1225–1229. doi:10.1109/VTC.2001.956971.

Techniques for improving cellular radio base station energy efficiency. 2011. Volume 18. 5. Heriot-Watt University and University of Edinburgh. doi:10.1109/MWC.2011.6056687.

Minh, Hoa Le, Dominic O'Brien, Grahame Faulkner, Lubin Zeng, Kyungwoo Lee, Daekwang Jung, and YunJe Oh. 2008. '80 Mbit/s Visible Light Communications using preequalized white LED'. *34th European Conference on Optical Communication* (): 1–2. doi:10.1109/ECOC.2008.4729532.

Motorola. 2008. 'Long Term Evolution A Technical Overview'. Visited on April 26, 2013. http://www.motorolasolutions.com/web/Business/Solutions/Industry%20Solutions/Service%20Providers/Wireless%20Operators/LTE/_Document/Static%20Files/6834_MotDoc_New.pdf.

———. 2013a. 'Horizon 3G-n macro Outdoor UMTS HSPA solution'. Visited on April 26, 2013. http://www.motorola.com/web/Business/Products/Cellular%20Networks/HSxPA/_Images/Horizon_3G-n_macro_Outdo.pdf.

Motorola. 2013b. 'Motorola M810 CDMA Picocell Base Station'. Visited on April 24, 2013. http://www.motorolasolutions.com/XP-EN/Business+Product+and+Services/Cellular+Networks/M810+Picocell+Base+Station_SG-EN_MY-EN_IN-EN_XA-EN, HK-EN, TH-EN, ID-EN, PH-EN, XP-EN.

Moungnoul, P., and M. Pongsuwanporn. 2007. 'Capacity analysis of macro and microcell layout in W-CDMA cellular system'. *Asia-Pacific Conference on Communications* (): 253–256. doi:10.1109/APCC.2007.4433547.

Ndong, Massa, and Takeo Fujii. 2011. 'Interference Cancellation for Spectrum Shared Femtocell Networks with Macrocell Information Feedback'. *Third International Conference on Ubiquitous and Future Networks* (Dalian, China) (): 224–229. doi:10.1109/ICUFN.2011.5949166.

Niu, Zhisheng. 2011. 'TANGO: traffic-aware network planning and green operation'. *IEEE Wireless Communications* 18, number 5 (): 25–29. doi:10.1109/MWC.2011.6056689.

Niu, Zhisheng, Yiqun Wu, Jie Gong, and Zexi Yang. 2010. 'Cell zooming for cost-efficient green cellular networks'. *IEEE Communications Magazine* (Beijing, China) 48, number 11 (): 74–79. doi:10.1109/MCOM.2010.5621970.

Niu, Zhisheng, Jianan Zhang, Xueying Guo, and Sheng Zhou. 2012. 'On Energy-Delay Tradeoff in Base Station Sleep Mode Operation'. *IEEE International Conference on Communication Systems* (): 235–239. doi:10.1109/ICCS.2012.6406145.

'Nokia Siemens Networks 3G Femtocell Solution'. 2013. Nokia Siemens Networks. <http://nsn.com/portfolio/solutions/heterogeneous-networks/femtocell>.

'Nokia Siemens Networks Flexi Lite Base Station'. 2013. Nokia Siemens Networks. <http://nsn.com/portfolio/products/mobile-broadband/single-ran-advanced/flexi-lite-base-station>.

'2020: Beyond 4G Radio Evolution for the Gigabit Experience'. 2011. Nokia Siemens Networks. Visited on August 20, 2011. http://nsn.com/sites/default/files/document/nokia_siemens_networks_beyond_4g_white_paper_online_20082011_0.pdf.

‘10 x 10 x 10 the formula for beyond 4G’. 2012. Nokia Solutions and Networks. Visited on September 18, 2012. <http://nsn.com/news-events/publications/unite-magazine-issue-10/10-x-10-x-10-the-formula-for-beyond-4g>.

Nylander, Tomas, Johan Rune, and Jari Vikberg. 2012. *Energy Efficient Base Station Entering Sleep Mode*. Patent US 13/379,609 and US20120106423 A1. USPTO. <http://www.google.com/patents/US20120106423>.

Oliveira, Carlos, Jaime Bae Kim, and Tatsuya Suda. 1998. ‘An Adaptive Bandwidth Reservation Scheme for High-Speed Multimedia Wireless Networks’. *IEEE Journal on selected areas in communications* 16, number 6 (): 858–874. doi:10.1109/49.709449.

A bandwidth trading marketplace for mobile data offloading. 2013. University of Bergamo, Université Paris-Sud, and Politecnico di Milano. doi:10.1109/INFCOM.2013.6566809.

Pathak, Parth H., and Rudra Dutta. 2011. ‘A Survey of Network Design Problems and Joint Design Approaches in Wireless Mesh Networks’. *IEEE Communications Surveys and Tutorials* (Raleigh, NC 27606, USA) 13 (3): 396–428. doi:10.1109/SURV.2011.060710.00062.

Traffic-Driven Power Saving in Operational 3G Cellular Networks. 2011. Los Angeles, CA 90095, USA and Beijing 100084, China: UCLA and Tsinghua University, ACM New York, NY, USA. doi:10.1145/2030613.2030628.

Perahia, Eldad, Carlos Cordeiro, Minyoung Park, and L. Lily Yang. 2010. ‘IEEE 802.11ad Defining the Next Generation Multi-Gbps Wi-Fi’. *7th IEEE Consumer Communications and Networking Conference* (Hillsboro, OR 97124, USA) (): 1–5. doi:10.1109/CCNC.2010.5421713.

Pisek, Eran, Sridhar Rajagopal, and Shadi Abu-Surra. 2012. ‘Gigabit Rate Mobile Connectivity Through Visible Light Communication’. *IEEE International Conference on Communications* (): 3122–3127. doi:10.1109/ICC.2012.6363739.

- Popovski, Petar, Hiroyuki Yomo, Kentaro Nishimori, Rocco Di Taranto, and Ramjee Prasad. 2007. 'Opportunistic Interference Cancellation in Cognitive Radio Systems'. *2nd IEEE International Symposium on New Frontiers in Dynamic Spectrum Access Networks* (Dublin, Ireland) (): 472–475. doi:10.1109/DYSPAN.2007.68.
- Qamar, Rahim A., and Noor M. Khan. 2009. 'Null Steering, A Comparative Analysis'. *Null Steering, A Comparative Analysis* (): 1–5. doi:10.1109/INMIC.2009.5383130.
- Qiu, Lili, Paramvir Bahl, Ananth Rao, and Lidong Zhou. 2006. 'Troubleshooting Wireless Mesh Networks'. *ACM SIGCOMM Computer Communication Review* 36, number 5 (): 17–28. doi:10.1145/1163593.1163597.
- Radwan, Ayman, and Jonathan Rodriguez. 2012. 'Energy Saving in Multi-standard Mobile Terminals through Short-range Cooperation'. *EURASIP Journal on Wireless Communications and Networking 2012* (). doi:10.1186/1687-1499-2012-159. <http://jwcn.eurasipjournals.com/content/2012/1/159>.
- Rappaport, Theodore S., Shu Sun, Rimma Mayzus, Hang Zhao, Yaniv Azar, Kevin Wang, George N. Wong, Jocelyn K. Schulz, Mathew Samimi, and Felix Gutierrez. 2013. 'Millimeter Wave Mobile Communications for 5G Cellular: It Will Work!' *IEEE Access* 1 (): 335–349. doi:10.1109/ACCESS.2013.2260813.
- Rinaldi, P., and G.M. Veca. 2007. 'The hydrogen for base radio stations'. *29th International Telecommunications Energy Conference* (): 288–292. doi:10.1109/INTLEC.2007.4448784.
- Roberts, Rick. 2013. 'On Study Group Status for Camera Communications'. Intel Labs. <https://mentor.ieee.org/802.15/dcn/13/15-13-0398-00-01ed-on-study-group-status-for-camera-communications.pdf>.
- Rouse, T., I. Band, and S. McLaughlin. 2002. 'Capacity and power investigation of opportunity driven multiple access (ODMA) networks in TDD-CDMA based systems'. *IEEE International Conference on Communications* 5:3202–3206. doi:10.1109/ICC.2002.997426.

Rouse, T., S. McLaughlin, and H. Haas. 2001. 'Coverage capacity analysis of opportunity driven multiple access (ODMA) in UTRA TDD'. *Second International Conference on 3G Mobile Communication Technologies*, number 477 (): 252–256. doi:10.1049/cp:20010051.

Rusek, Fredrik, Daniel Persson, Buon Kiong Lau, Erik G. Larsson, Thomas L. Marzetta, Ove Edfors, and Fredrik Tufvesson. 2013. 'Scaling Up MIMO: Opportunities and Challenges with Very Large Arrays'. *IEEE Signal Processing Magazine* 30, number 1 (): 40–60. doi:10.1109/MSP.2011.2178495.

Energy-aware Web Caching for Mobile Terminals. 2002. Inria -Rocquencourt Domaine de Voluceau, Rocquencourt, BP 105,78153 Le Chesnay Cédex, France: 22nd International Conference on Distributed Computing Systems Workshops, IEEE. doi:10.1109/ICDCSW.2002.1030869.

Saker, L., S.E. Elayoubi, Letian Rong, and Tijani Chahed. 2011. 'Capacity and Energy Efficiency of Picocell Deployment in LTE-A Networks'. *IEEE 73rd Vehicular Technology Conference* (): 1–5. doi:10.1109/VETECS.2011.5956501.

Saleh, Abdallah Bou, Ömer Bulakci, Simone Redana, Bernhard Raaf, and Jyri Hämäläinen. 2012. 'Evaluating the energy efficiency of LTE Advanced relay and Picocell deployments'. *IEEE Wireless Communications and Networking Conference* (): 2335–2340. doi:10.1109/WCNC.2012.6214184.

Mobile agents: What about them? Did they deliver what they promised? Are they here to stay? 2004. CY-1678 Nicosia, Cyprus: Department of Computer Science, University of Cyprus. doi:10.1109/MDM.2004.1263075.

Selection of Mobile Agents. 2004. 2-1-2 Hitotsubashi, Chiyoda-ku, Tokyo 101-8430, Japan: National Institute of Informatics. doi:10.1109/ICDCS.2004.1281615.

Schiavone, Leonard, and David Hendry. 2011. 'EHF options for contested SATCOM'. *MILITARY COMMUNICATIONS CONFERENCE* (): 2292–2295. doi:10.1109/MILCOM.2011.6127663.

- LED-to-LED Visible Light Communication Networks*. 2013. Zürich, Switzerland: Disney Research and ETH Zürich. doi:10.1145/2491288.2491293.
- Shi, Yongsheng, Allen B. MacKenzie, Luiz A. DaSilva, Kaveh Ghaboosi, and Matti Latvaaho. 2010. 'On Resource Reuse for Cellular Networks with Femto- and Macrocell Coexistence'. *IEEE Global Telecommunications Conference ()*: 1–6. doi:10.1109/GLOCOM.2010.5683443.
- Shor, Gadi. 2008. 'How Bluetooth, UWB, and 802.11 stack up on power consumption'. *Wissair*. Visited on May 31, 2013. http://www.eetimes.com/document.asp?doc_id=1273546.
- Silicon, Leading-Edge Cluster Cool. 2013. 'Cool Silicon'. <http://cool-silicon.de/>.
- 'Small Cells, FAQ'. 2013. Visited on April 26, 2013. <http://www.smallcellforum.org/aboutsmallcells-small-cells-consumer-faqs>.
- Cell vs. WiFi: on the performance of metro area mobile connections*. 2012. Colgate University and University of Wisconsin, ACM New York, NY, USA.
- Sulonen, Kati, Pasi Suvikunnas, Lasse Vuokko, Jarmo Kivinen, and Pertti Vainikainen. 2003. 'Comparison of MIMO Antenna Configurations in Picocell and Microcell Environments'. *IEEE Journal on Selected Areas in Communications* 21, number 5 (): 703–712. doi:10.1109/JSAC.2003.810297.
- Sutton, Andy, and Angus Cameron. 2011. 'Building better backhaul'. *Engineering and Technology* 6, number 5 (): 72–75. ISSN: 1750-9637.
- Taniuchi, Kenichi, Yoshihiro Ohba, Victor Fajardo, Subir Das, Miriam Tauil, Yuu-Heng Cheng, Ashutosh Dutta, Donald Baker, Maya Yajnik, and David Famolari. 2009. 'IEEE 802.21: Media Independent Handover: Features, Applicability, and Realization'. *IEEE Communications Magazine* 47, number 1 (): 112–120. doi:10.1109/MCOM.2009.4752687.
- Tecore. 2013. 'Tecore All-In-One 3G-4G'. <http://tecore.com/solutions/TecoreNetworks-Datasheet-All-In-One3G-4GEnterpriseFemtocellSystem.pdf>.

Tombaz, Sibel, Anders Västberg, and Jens Zander. 2011. 'Energy- and Cost-Efficient Ultra-High-Capacity Wireless Access'. *IEEE Wireless Communications* 18, number 5 (): 18–24. doi:10.1109/MWC.2011.6056688.

Tran, Hung, Hans-Jürgen Zepernick, and Hoc Phan. 2012. 'Impact of the number of antennas and distances among users on cognitive radio networks'. *International Conference on Advanced Technologies for Communications* (): 136–140. doi:10.1109/ATC.2012.6404246.

Trillo, Raquel, Sergio Ilarri, and Eduardo Mena. 2007. 'Comparison and Performance Evaluation of Mobile Agent Platforms'. *Third International Conference on Autonomic and Autonomous Systems* (Maria de Luna, 1 E-50018 Zaragoza, Spain) (): 41. doi:10.1109/CONIELECOMP.2007.66.

Ubee-AirWalk. 2013. 'Ubee-AirWalk EdgePoint Pro'. <http://www.ubeeairwalk.com/products/enterprise-femtocells.html>.

UBIQUISYS. 2013. 'UBIQUISYS SerComm FC17xU Series'. <http://www.ubiquisys.com/small-cells-femtocells-products>.

USA, IDC Corporate. 2012. 'IDC Expects Smart Connected Device Shipments to Grow by 14% Annually Through 2016, Led by Tablets and Smartphones'. <http://www.idc.com/getdoc.jsp?containerId=prUS23703712>.

Wang, Li-Chun, and Suresh Rangapillai. 2012. 'A Survey on Green 5G Cellular Networks'. *International Conference on Signal Processing and Communications* (): 1–5. doi:10.1109/SPCOM.2012.6290252.

Wang, Peng, Jun Xiao, and Li Ping. 2006a. 'Comparison of orthogonal and non-orthogonal approaches to future wireless cellular systems'. *IEEE Vehicular Technology Magazine* 1, number 3 (): 4–11. doi:10.1109/MVT.2006.307294.

———. 2006b. 'Correction to "Comparison of Orthogonal and Non-Orthogonal Approaches to Future Wireless Cellular Systems"'. *IEEE Vehicular Technology Magazine* 1, number 4 (): 42. doi:10.1109/MVT.2006.343643.

Wang, Rui, and Yinggang Du. 2011. 'HetNet Throughput Analysis with Pico-cell Interference Cancellation'. *IEEE International Conference on Communications Workshops* (): 1–6. doi:10.1109/iccw.2011.5963600.

Veen, Barry D. Van, and Kevin M. Buckley. 1988. 'Beamforming: A Versatile Approach to Spatial Filtering'. *IEEE ASSP MAGAZINE* 5, number 2 (): 4–24. doi:10.1109/53.665. http://www.engr.wisc.edu/ece/faculty/vanveen_barry/ASSP_Mag_88.pdf.

Weng, Xiangnan, Dongxu Cao, and Zhisheng Niu. 2011. 'Energy-Efficient Cellular Network Planning under Insufficient Cell Zooming'. *IEEE 73rd Vehicular Technology Conference (Beijing, P.R.China)* (): 1–5. doi:10.1109/VETECS.2011.5956699.

Mobile agents: ten reasons for failure. 2004. Santa Barbara, CA, USA: Department of Computer Science, California University. doi:10.1109/MDM.2004.1263077.

Wikipedia. 2013. 'Small Cells'. Visited on April 8, 2013. http://en.wikipedia.org/wiki/Small_Cells.

Won, Euntae. 2008. *SG VLC Project Draft 5C*. Project Draft. IEEE P802.15 Working Group for WPANs. <https://mentor.ieee.org/802.15/file/08/15-08-0667-01-0v1c-5c-draft.pdf>.

Wu, J.-S., J.-K. Chung, and M.-T. Sze. 1997. 'Analysis of uplink and downlink capacities for two-tier cellular system'. *IEE Proceedings Communications* 144, number 6 (): 405–411. doi:10.1049/ip-com:19971648.

Vučić, J., C. Kottke, S. Nerreter, A. Büttner, K.-D. Langer, and J. W. Walewski. 2009. 'White Light Wireless Transmission at 200+ Mb/s Net Data Rate by Use of Discrete-Multitone Modulation'. *IEEE Photonics Technology Letters* 21, number 20 (): 1511–1513. doi:10.1109/LPT.2009.2028696.

Xiao, Qun, Jeffrey L. Hesler, Thomas W. Crowe, Jr. Bascom S. Deaver, and Robert M. Weikle II. 2007. 'A 270-GHz Tuner-Less Heterostructure Barrier Varactor Frequency Tripler'. *IEEE Microwave and Wireless Components Letters* 17, number 4 (): 241–243. doi:10.1109/LMWC.2007.892932.

Xie, Hai, Louay Jalloul, Ching Yao Huang, Ning Zhang, and Ashwin Sampath. 1994. 'Improved performance of a CDMA cellular system with macrocell diversity'. *Third Annual International Conference on Universal Personal Communications* (San Diego, CA, USA) (): 56–61. doi:10.1109/ICUPC.1994.383059.

Xie, Liang-Liang, and P. R. Kumar. 2007. 'Multi-source, multi-destination, multi-relay wireless networks'. *IEEE Trans. Information Theory* 53, number 10 (): 3586–3595. doi:10.1109/TIT.2007.904783.

Zeng, Lubin, Dominic C. O'Brien, Hoa Le Minh, Grahame E. Faulkner, Kyungwoo Lee, Daekwang Jung, YunJe Oh, and Eun Tae Won. 2009. 'High Data Rate Multiple Input Multiple Output (MIMO) Optical Wireless Communications Using White LED Lighting'. *IEEE Journal on Selected Areas in Communications* 27, number 9 (): 1654–1662. doi:10.1109/JSAC.2009.091215.

Zhou, Qi, and Xiaoli Ma. 2011. 'Robust Designs for Femtocell Networks with Interference from Macrocell Users'. *IEEE GLOBECOM Workshops* (Houston, TX, USA) (): 214–218. doi:10.1109/GLOCOMW.2011.6162440.

Zhou, Sheng, Andrea J. Goldsmith, and Zhisheng Niu. 2011. 'On Optimal Relay Placement and Sleep Control to Improve Energy Efficiency in Cellular Networks'. *IEEE International Conference on Communications* (): 1–6. doi:10.1109/icc.2011.5963235.

Zhou, Sheng, Jie Gong, Zexi Yang, Zhisheng Niu, and Peng Yang. 2009. 'Green Mobile Access Network with Dynamic Base Station Energy Saving'. *The 15th Annual International Conference on Mobile Computing and Networking* (Beijing, China) (): 1–3.

Zhu, Xiaoyan, Yuguang Fang, and Yumin Wang. 2010. 'How to secure multi-domain wireless mesh networks'. *Wireless Networks* 16, number 5 (): 1215–1220. doi:10.1007/s11276-009-0198-6.

Appendices

A Octave code listing for the DMC simulation

```
1 clear all;clc;
2 X=0;
3 RR=0;
4 DMCvec=50;
5 iterations=200;
6 d0=1; % Reference distance is 1
7 Pt=1; % Transmitted power is 1
8 % Vector of DMC-cloud sizes is (5,10,15...):
9 for i=1:DMCvec
10     X(i)=X(end)+5;
11 end
12 % Distance of MTs in the DMC is chosen to be 5
13 distance=5;
14 %-----
15 % This loop fills the MT-vector with
16 % SPLM-calculations for each MTs. Each MT in the
17 % vector has a difference of 1 metre.
18 %
19 %  $Pt - (Pt * (d0/i)^2)$  calculates the losses, or the
20 % power difference, because SPLM tells only the
21 % received power, not the losses themselves.
22 for i=1:X(end)
23     MT(i)=Pt - (Pt * (d0/i)^2);
24 end
25 %-----
26 % Loops that fill the vector RR with random MTs
27 % between 2 and X(end), which then fill a
```

```

28 % vector RRsum with sums of the RR's.
29 % 'best' is a vector with summed values from the
30 % first MT and a 'loop count'—amount of other MTs
31 % with a distance of 'distance'.
32 % The vectors 'RRsum' and 'best' are then evaluated
33 % into 2D-matrix V.
34 for j=1:length(X)
35     for e=1:iterations
36         for i=1:X(j)
37             RR(i)=MT(1+randi(X(end)-1));
38         end
39         RRsum(j)=sum(RR);
40         best(j)=MT(2)+((X(j)-1)*MT(distance));
41         V(e,j)=RRsum(j)/best(j);
42     end
43 end
44 %—————averaging the matrix—————
45 for d=1:DMCvec
46     H(d)=sum(V(:,d))/length(V(:,d));
47 end
48 %—————plotting-related commands—————
49 plot(X,H);
50 title('DMC_power_comparison');
51 xlabel('Number_of_MTs_in_the_cloud');
52 ylabel('Power_consumed_in_a_RR-cloud_relative_to_DMC-
communications');
53 legend('Relative_power_consumption');
54 set(gca, 'Box', 'off', 'TickDir', 'Out');
55 print -deps2 ../kuvia/splm.eps
56 print -dpng ../kuvia/splm.png

```

B Octave code listing comments

Variable	Description
<code>DMCvec = 50</code>	Number to determine the length of the DMC-cloud size vector.
<code>iterations = 200</code>	Number of averaging iterations performed.
<code>d0 = 1</code>	Reference distance for the SPLM-calculation (<i>in m</i>).
<code>Pt = 1</code>	Transmitted power.
<code>distance = 5</code>	Average distance between the MTs in the DMC.

Line number	Description
9 ~ 11	For-loop for calculating the vector of DMC-cloud sizes according to the variable <code>DMCvec = 50, (5, 10, 15 ...)</code> .
22 ~ 24	For-loop for filling the MT-vector with SPLM-calculations. Each for-loop iteration (<i>i.e.</i> MT) in the vector has a difference of 1 metre. The formula $P_t - P_t * \left(\frac{d_0}{t}\right)^2$ calculates the losses, or <i>the power difference</i> between the transmitter and the receiver, due to the fact that SPLM tells only the received power, not the losses themselves.
34 ~ 43	For-loops for filling the round-robin (<i>RR</i>) vector with randomly picked MTs from the pool of calculated SPLM-MT-values between 2 and <code>X(end)</code> (<i>X(end) is 200 in this case</i>). Values of <i>RR</i> are then summed and used to fill a vector called <code>RRsum.best</code> is a vector with summed values from the first MT, added with a <i>for-loop count</i> -amount of other MTs with a distance of <code>distance</code> – which in this case is 5. The vectors <code>RRsum</code> and <code>best</code> are then divided into 2-D matrix <code>V</code> .
45 ~ 47	For-loop for iterating the averages for the matrix <code>V</code> into vector <code>H(iterations = 200)</code> .
49 ~ 56	Various plotting and printing related commands.

Table 3. Octave code listing comments.