

**THE EFFECTS OF MUSCLE HISTORY ON SHORT
LATENCY STRETCH RESPONSE OF SOLEUS MUSCLE**

Jouni Kallio

Jyväskylän Yliopisto
Liikuntabiologian laitos
Biomekaniikka
Pro gradu –tutkielma
Työn ohjaaja P.V. Komi
Kevät 2002

ABSTRACT

Kallio, Jouni Juhani. The effects of muscle history on short latency stretch response of Soleus muscle. Liikuntabiologian laitos. Jyväskylän Yliopisto. 2002, 49 s.

The previous muscle history has been found to affect the properties of short latency stretch reflex (SLR) (Nakazawa et al. 1997a, 1998; Ogiso et al. 2002a,b). The purpose of the present study was to investigate the effect of preceding movement, activation and stretching velocity on short latency stretch reflex response.

Eight healthy males (26.0 ± 1.4 years, 177.3 ± 5.9 cm, 75.8 ± 8.1 kg) participated in the study. Triceps Surae muscles were stretched in both passive and active conditions by eliciting rapid 4 deg. dorsiflexions about the right ankle joint. Stretches were performed while the muscle was static (ISO), lengthening (LEN) or shortening (SHO). Each stretch was evoked at the same ankle joint angle with three stretching velocities (70, 120, 200 deg· s⁻¹). Stretches were elicited to passive muscle and with voluntary activity (10-25% MVC). Surface EMG activity was measured from Soleus muscle with measures of reflex latency, duration and peak-to-peak amplitude.

In passive muscle, the peak-to-peak amplitude of (SOL) SLR was significantly greater ($p < 0.05$) in ISO than in SHO or LEN in all three stretching velocities. In addition, with the slowest stretching velocity only one of the eight subjects had a detectable response in SHO and only five in LEN. Smaller EMG responses in dynamic pre-conditions were accompanied with significantly smaller torque responses compared with ISO. Voluntary activation decreased the differences in SLR between dynamic and ISO conditions. No significant differences were found between ISO and SHO in any velocities, while SLR in LEN was significantly smaller than ISO or SHO at the fastest velocity.

Smaller amplitude and longer latency of passive SLR in SHO are probably due to slackening of intrafusal fibres. This mechanism is supported by the notions, that with voluntary activity the accompanied fusimotor activation shortened SHO reflex latency and increased its amplitude to the same level as in ISO. The mechanism behind the

smaller SLR amplitude in LEN may be related to inhibition from Golgi afferents or mechanical changes at the spindle level.

CONTENTS

1	INTRODUCTION	5
2	REVIEW OF THE LITERATURE.....	6
2.1	Physiology of the neuromuscular system.....	6
2.2	Reflex control in movement.....	8
2.2.1	The stretch reflex.....	8
2.2.2	Function of the stretch reflex	9
2.2.3	Factors affecting short latency stretch reflex (SLR)	11
3	THE PURPOSE OF THE STUDY	14
4	METHODS	15
4.1	Subjects	15
4.2	Protocol & measurements	15
4.3	Apparatus	19
4.4	Analysis.....	21
4.4.1	MVC.....	21
4.4.2	Stretch measurements.....	21
4.5	Statistics	22
5	RESULTS	23
5.1	MVC.....	23
5.2	Passive stretches.....	23
5.3	Stretches with activation	28
6	DISCUSSION	30
6.1	Level of activation.....	30
6.2	Torque in trials with activation	32
6.3	Mechanisms affecting reflex parameters	33
6.3.1	Changes in motoneuron pool	34
6.3.2	Proprioceptors with facilitatory and inhibitory responses.....	34
6.4	Applications to locomotion.....	39
	YHTEENVETO	41
	REFERENCES.....	43

1 INTRODUCTION

When a skeletal muscle is lengthened fast enough, the stretch in the muscle spindles activates afferent neurons that facilitate the α -motoneurons of the same muscle. This opposing muscle contraction is called the stretch reflex. The function of the stretch reflex is to regulate muscle stiffness during movement caused by voluntary contraction or external perturbations and to compensate for nonlinearities of the intrinsic responses (for review, see Nichols et al. 1999). Stretch reflex may also be essential in the storage of elastic energy in stretch-shortening type activities (Gollhofer et al. 1992; Komi et al. 1986).

Despite the important contributions of stretch reflex, mechanisms affecting reflex sensitivity in normal locomotion, such as walking (Sinkjaer et al. 1996, Stein & Capaday 1988), are still unclear. In normal locomotion muscles are stretched by external reaction forces. These perturbations cause muscles to stretch in varying velocities and amplitudes. Also the type and magnitude of the muscle activity preceding the stretch may vary. It is thus important to gain knowledge about the effects of previous muscle history on reflex sensitivity in order for us to understand the spinal control-mechanisms behind normal locomotion.

The muscle activity type and magnitude preceding the stretch have previously been found to affect reflex EMG- and torque responses of elbow flexors (Nagazawa et al. 1997a; 1998) and ankle plantarflexors (Ogiso 2002a,b). These studies have either been limited to active tracking tasks (Nagazawa et al. 1997a; 1998) or to only one stretching velocity (Ogiso 2002a,b). Hence, the purpose of present study was to gain more information on the effects of stretching conditions on the short latency stretch reflex (SLR) by investigating the combined effects of stretching velocity, and type and magnitude of muscle activity on the short latency component of the stretch reflex.

2 REVIEW OF THE LITERATURE

2.1 Physiology of the neuromuscular system

Production of muscle torque is affected by muscle activation and the mechanical state of the musculoskeletal system. Muscle activation is determined by the sum of central command and afferent feedback, whereas variables like muscle length, velocity of contraction, and moment arm affect the output of the active muscle (for review, see Enoka 1994).

The recruitment of motor units is believed to follow a specific orderly pattern where the smallest units are recruited first (Henneman et al. 1965a,b). Some alterations to orderly recruitment have been reported in eccentric muscle actions (e.g. Nardone et al. 1989).

For the proper function of the neuromuscular system, feedback is required from the imposed movements, as well as from external perturbations. Exteroceptors provide the CNS with information about the surrounding environment, whereas proprioceptors detect the state of the system from within. Proprioceptors include muscle spindles that sense changes in length, tendon organs that detect tension, and joint receptors that sense joint position (Fig. 1). (McMahon 1984.)

Spindles lay inside the muscles parallel to extrafusal fibres and thus experience the same relative length changes as the surrounding muscle. Spindles consist of intrafusal fibres that have both efferent (γ) and afferent (Ia, II) neural connections to the spine (Fig. 2). The sensory region of spindle is sensitive to stretch. This stretching can be caused by extrafusal lengthening, or by the shortening of the contractile end-parts of the intrafusal fibres. During voluntary contraction, extrafusal shortening is compensated by the contraction of intrafusal fibres. This co-activation eliminates slackening of the spindles. (For review, see Matthews 1981.) The function of spindles in stretch reflex is discussed below.

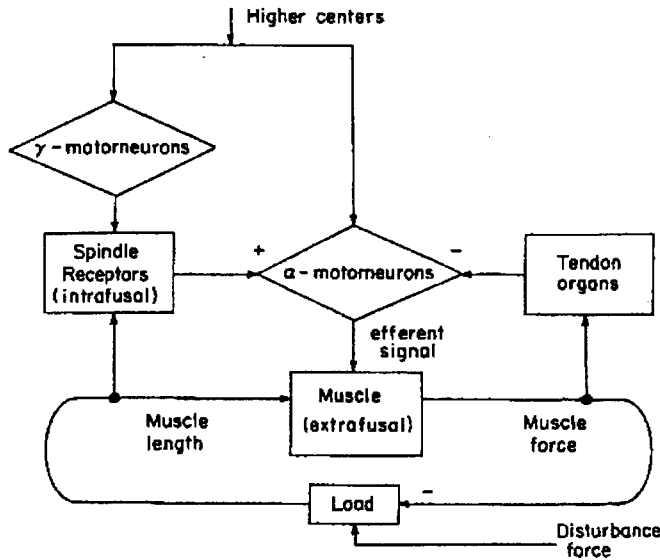

Figure 1. A schematic diagram illustrating stiffness regulation in the stretch reflex. α -motoneurons are facilitated by central commands from higher centers and afferent activity from spindle, whereas tendon organs send inhibitive signals. The efferent signal is a sum of the two. (Houk 1979)

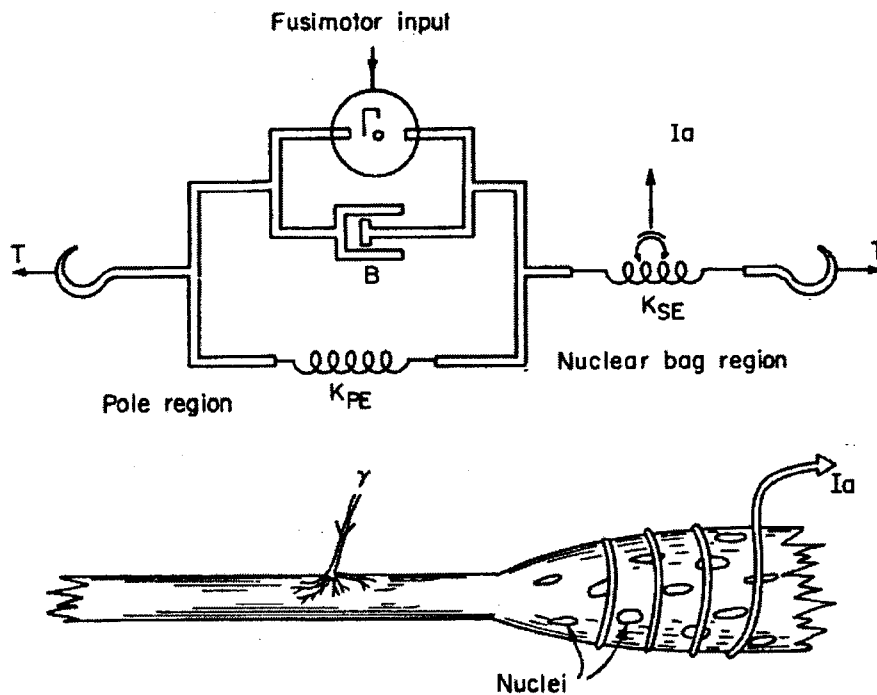

Figure 2. Schematic diagram of half of a nuclear bag fiber from a muscle spindle. K_{SE} = sensory region, whose stretch is sensed by the Ia afferent endings. This region can be stimulated by external stretch (T) or by fusimotor input (γ -motoneuron) that contracts the pole regions of the spindle. Modified from McMahon (1984).

2.2 Reflex control in movement

Reflex can be defined as receptor facilitation that leads to a motor response without conscious voluntary activation. Reflexes protect the system against potentially harmful disturbances and compensate for the external perturbations, usually through negative feedback (Houk et al. 1981).

2.2.1 The stretch reflex

When a skeletal muscle is lengthened at a sufficient velocity, the mechanical response includes two components. The first, intrinsic component begins at stretch onset and is caused by the viscous properties of the muscle. A second, reflex component begins approximately 30 ms later (Sinkjaer et al. 1988). This second response results from the activity of a monosynaptic, homonymous reflex pathway that is triggered by the stretching of muscle spindles (Hammond 1954).

When spindles are stretched, an afferent signal is launched to the spine via Ia afferents. These neurons have monosynaptic facilitative connections to most of the α -motoneurons innervating the same muscle. If the stretch is adequate, enough activation is formed to trigger muscle contraction. (Enoka 1994.)

The reflex response in EMG consists of at least two identifiable components (Fig. 3). The first, short-latency response (M1 or short-latency reflex, SLR) has a latency of approximately 30 ms and is the result of the aforementioned monosynaptic reflex-loop. The second component (M2 or long-latency reflex, LLR) appears 50-60 ms after stretch onset and has a longer, polysynaptic reflex loop. Sometimes a third component (M3) is detected before the beginning of the earliest voluntary activity at 170 ms after perturbation. (Tatton et al. 1975.)

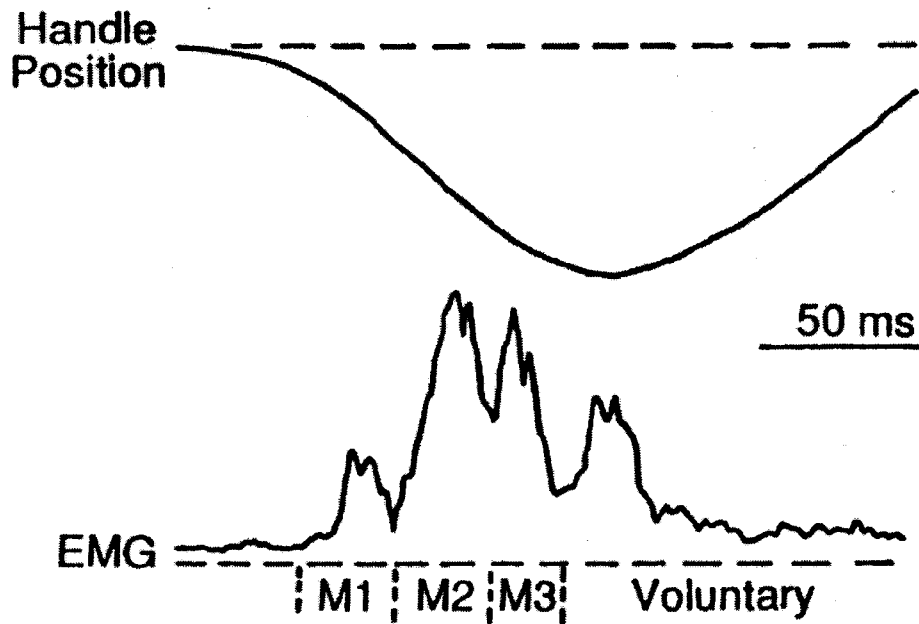

Figure 3. An averaged, rectified EMG response. M1-M3 are the different latency components of the stretch reflexes (see text for details). From Matthews 1991.

2.2.2 Function of the stretch reflex

Reflexes are essential in the control of locomotion. In fact, many locomotive tasks, such as standing and walking, can be completed even when the brains are removed. The mechanical behaviour of a muscle can be quite different with or without reflex control, as can be seen in Fig. 4A. (McMahon 1984.)

It is widely agreed, that rather than muscle tension or length, tendomuscular stiffness (ratio between the change in muscle resistance and the change in muscle length) serves as the regulated property in reflex action (Nichols & Houk 1976). The main purpose of reflex activity is to increase joint stiffness and to compensate for nonlinearities of the intrinsic responses (for review, see Nichols et al. 1999). Reflex stabilizes the stiffness during and after the stretch, especially after the yielding-phase that results from the breakage of cross-bridges that account for the so-called short-range stiffness (for review, see Houk & Rymer 1981). It has been suggested, that reflex activity is needed for the effective utilization of elastic energy in stretch-shortening type activities (Komi

et al. 1986; Gollhofer et al. 1992). Fatigue decreases reflex sensitivity, which in turn decreases the stiffness after ground contact (Fig. 4B; Avela et al. 1999b).

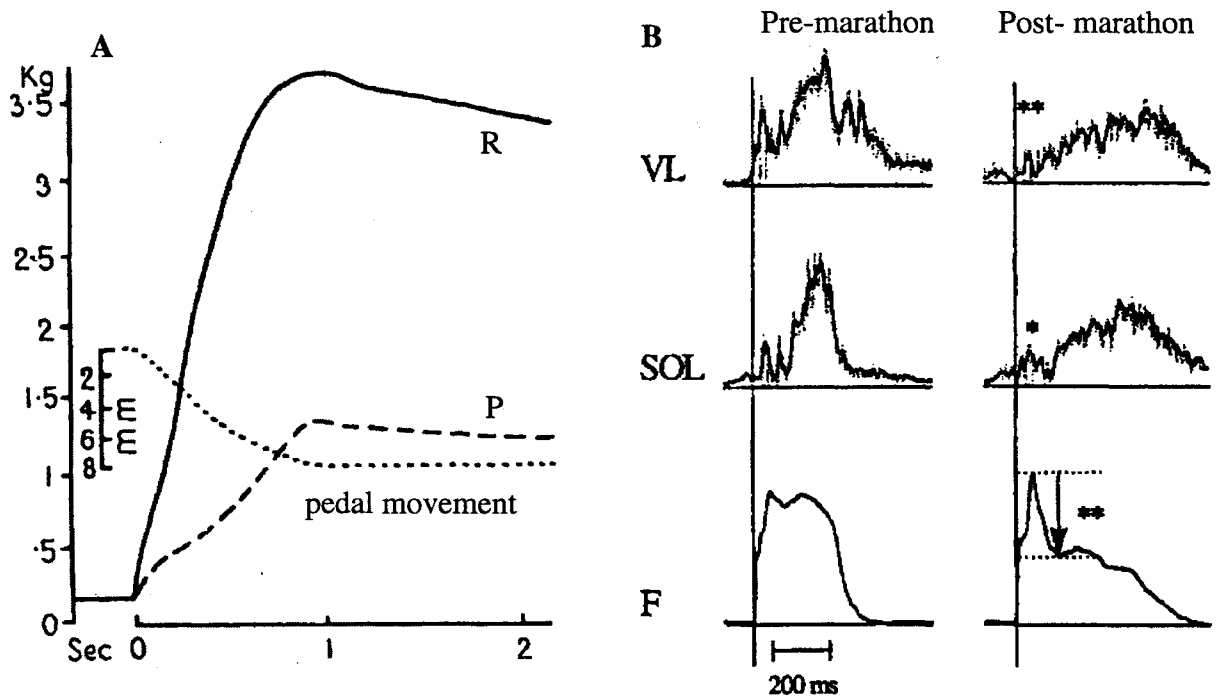

Figure 4. The contribution of reflex on torque after stretch. These two examples illustrate the significant effects that eliminated or decreased reflex activity has on torque production after stretch. A: R shows the force produced by the muscle with reflexes intact, and P is the passive force produced after cutting the motor nerve (From Liddell & Sherrington 1924 in Enoka 1994). B: The effect of fatigue-induced decrease in reflex sensitivity on reaction force (F) in sledge jumps. Averaged, rectified EMG patterns of the VL and SOL muscles and reaction force (F) in sledge jumps before and after marathon running. * and ** indicate significances (* $P < 0.05$ and ** $P < 0.01$) between pre- and post-marathon (From Avela et al. 1999b).

Contribution in locomotion The contribution of stretch reflex has been investigated in several motor tasks. Zehr & Stein (1999) suggested balance control after external perturbations as one of the main functions of reflex activity in locomotion. During walking reflex contributes to the plantarflexion during early stance (Sinkjaer & Andersen 1996), and up to 30-60% of soleus EMG could arise reflexly (Yang et al.

1991), while gastrocnemius SLR-activity is minimal (Dietz et al. 1987). Reflex activity has been found to contribute to running (Dietz et al. 1979) and jumping (Bosco et al. 1982; Voigt et al. 1998). Reflexes are also important in the deceleration after the ground contact in falling (Dietz & Noth 1978; Dietz et al. 1981).

2.2.3 Factors affecting short latency stretch reflex (SLR)

The monosynaptic short latency stretch reflex (SLR) is very fast and simple compared to other parts of our motor feedback system. Several factors affecting longer duration reflexes do not alter the monosynaptic SLR (e.g. Doemges & Rack 1992). However, numerous mechanisms have been reported to change the SLR characteristics.

Subject. Intersubject variations in SLR parameters have been reported to affect different reflex parameters. Height, age and leg length have been found to correlate with Achilles tendon-tap reflex latency (Kuruoglu & Oh 1993). Also training background has been found to affect reflex responses, endurance-trained athletes being more sensitive to stretch stimulus than power-trained individuals (Kyröläinen & Komi 1994).

Muscle. Skeletal muscles differ in size, structure and function, and they serve different tasks during human posture and locomotion. Also the reflex sensitivities vary, even between synergistic muscles: biceps brachii and brachioradialis (Nakazawa et al. 1998; 2001), and soleus and gastrocnemius (Houk & Rymer 1981). In addition the sensitivities between antagonists have been found to differ both in upper (Nakazawa et al. 2001) and lower limbs (Stein & Kearney 1995). There are two possible reasons for the intermuscular differences in reflex sensitivity. Firstly, muscles have differences in spindle densities (Botterman et al. 1978) and secondly, muscle fiber types differ in their sensitivity to afferent facilitation, slow-twitch fibres being more sensitive (Burke et al. 1970).

Velocity. There are several known relationships between stretch properties and the consequent reflex responses. Numerous authors have reported a positive correlation between external stretch velocity and the size of the reflex response (e.g. Gottlieb & Agarwal 1979; Kyröläinen & Komi 1994), and a negative correlation between velocity

and reflex latency (e.g. Kyröläinen & Komi 1994). When discussing muscle length changes, one should always consider the difference between tendomuscular complex and the contractile component. External stretching velocity has been found to correlate poorly with internal velocity of the contractile component, especially with low levels of activity (Eng & Hoffer 1997). Furthermore, reflex amplitude has been reported to negatively correlate with the estimated spindle stretch velocity (Voigt et al. 1998). However, in vivo measurements on cat gastrocnemius have revealed a strong correlation between local EMG reflex amplitudes and local fiber stretching velocities (Eng & Hoffer 1997). Based on these measurements, the existence of local reflexes, indicating regional control of muscle length has been proposed. Ultrasound measurements suggest, that the response to disturbances at certain joint rotation velocity is the same, regardless of the actual stretching velocity applied to the fibres (Nagazawa et al. 2001).

Amplitude. Stretch amplitude appears to affect reflex response only when amplitudes are small: Stein & Kearney (1995) found that saturation in the growth of reflex amplitude with increasing ankle dorsiflexion amplitude was at 0.05 rad. Also the reflex mediated stiffness has been found to be independent of stretch amplitude between 2-7 deg. (Sinkjaer et al. 1988).

Muscle length. It has been reported, that the length of the muscle-tendon complex correlates with reflex amplitude (e.g. Fellows & Thilman 1989; Stein & Kearney 1995). This is suggested to be related to the more slackened spindles in short muscle lengths.

Background activity (BGA). There seems to be some disagreement concerning the relationship between BGA and SLR. It is commonly agreed, that voluntary activation increases SLR size compared to passive stretches, possibly due to increased γ -activation and α -motoneuron facilitation. It is less clear to what extent further increase in activation affects SLR. The relationship between reflex amplitude and background activation or -torque has been found to be linear in humans (Gottlieb & Argaval 1979; Matthews 1986; Sinkjaer et al. 1988), while a non-linear increase has been observed in humans (Toft et al. 1991; Ogiso et al. 2002a) and decerebrate cats (Hoffer & Andreassen 1981a,b). In the latter studies, further increase in BGA did not affect reflex size.

Muscle history. Even when other affecting factors, such as BGA, muscle length and stretching velocity are controlled, marked variations in reflex EMG amplitude can be observed due to preceding movement of the muscle. In passive muscle, shortening (SHO) or lengthening (LEN) prior stretch onset has been found to reduce SLR compared to isometric (ISO) pre-condition (Ogiso et al. 2002a). It was suggested that the found variations were due to differences in muscle spindle sensitivity and afferent signals from other receptors. Decreased SLR in passive muscle has also been observed when stretch is superimposed on random perturbations (Stein & Kearney 1995). In active muscle similar differences between ISO and SHO have been found in wrist flexors (Bawa & Sinkjaer 1994), while no such differences existed in ankle plantarflexors (Ogiso et al. 2002a) or elbow flexors (Nagazawa et al. 1997a; 1998). The difference between ISO and LEN is not eliminated with voluntary activation (Nagazawa et al. 1997a; 1998; Ogiso et al. 2002a).

Locomotion. During human locomotion muscles undergo constant changes in length, activation and type of action, all of which affect stretch reflex responses. Reflex activity has been reported to be independent of voluntary activity during walking (Stein & Capaday 1988; Sinkjaer et al. 1996), and during different motor tasks (Dietz et al. 1994).

Other factors. Other reported mechanisms affecting SLR include the facilitative effect of pain (Matre et al. 1998), inhibition with fatigue (Nicol et al. 1996; Avela et al. 1999a,b) and selective decrease of stretch sensitivity in bed rest (Nakazawa et al. 1997a).

Application of H-reflex. Extensive research on the state of the motoneuron pool has been made utilizing the Hoffmann (H) reflex (Hoffmann 1918). With this method the afferent input to the motoneuron pool can be standardized. The H-reflex is easier to apply to moving subjects compared to mechanical stretches. As a method H-reflex bypasses the mechanical stimulus on the muscle spindles but is more affected by the total sum of facilitative and inhibitive inputs to the motoneuron pool. (Sinkjaer 1997.)

3 THE PURPOSE OF THE STUDY

The purpose of the present study was to investigate different factors affecting the short latency stretch response. The combined effects of preceding movement, background activation and stretching velocity on stretch reflex EMG- and torque-responses were investigated.

It was hypothesised that in passive muscle reflex sensitivity would be smaller when the stretch is induced to a lengthening or shortening muscle compared to static pre-condition. This decrease was hypothesised to be smaller in shortening but not in lengthening muscle when stretches were imposed on an active muscle.

4 METHODS

4.1 Subjects

Eight healthy male sports students (26.0 ± 1.4 years, height 177.3 ± 5.9 cm, weight 75.8 ± 8.1 kg) volunteered as subjects for the study. None of the subjects had any history of neuromuscular or vascular disease. All subjects gave informed consent to the procedure that was approved by the University Ethics Commission. (code of ethics of the World Medical Association, Declaration of Helsinki).

4.2 Protocol & measurements

The measurements consisted of maximal voluntary contractions and stretches in different situations. The test battery was as follows:

- a) Preparations₁ (surface electrodes, joint angles)
- b) MVC₁ (ISO, CON, ECC)
- c) Preparations₂ (wire electrodes)
- d) Stretch - passive condition (70, 120 & 200 deg· s⁻¹)
- e) Stretch - activation level 1 (70, 120 & 200 deg· s⁻¹)
- f) Stretch - activation level 2 (70, 120 & 200 deg· s⁻¹)
- g) MVC₂ (ISO, CON, ECC)

a) Preparations₁

The first part of the preparations included the adjustment of the dynamometer, measurement of ankle, knee and hip joint angles, and placing the surface electrodes.

b) Maximum voluntary contraction₁ (MVC₁)

Maximum voluntary contraction was measured in isometric (ISO), concentric (CON) and eccentric (ECC) situations. The order of muscle action types was randomized. The subject warmed up before measurements by performing submaximal isometric

contractions. In ISO the ankle was in the zero position (103 deg.) and subject was instructed to make a maximum voluntary contraction (MVC) in the plantarflexing direction for approximately 5 s. Moment and EMGs were recorded throughout the contraction and for 5 s before and after the contraction.

In dynamic conditions the range of motion was 10 degrees (0.35 rad). First the pedal was moved 10 deg. from the zero-position (103 deg.) to the starting position (in ECC 113 deg., in CON 93 deg.). With the pedal still, subject was instructed to perform a maximal isometric contraction. After full activation (1–2 s) of the plantarflexors, the pedal was rotated 10 deg. to the zero position at an angular velocity of $30 \text{ deg} \cdot \text{s}^{-1}$. The subject was instructed to maintain maximal activation throughout the movement.

c) Preparations₂

After the MVC-measurements the subject was removed from the dynamometer and wire electrodes were inserted. There are two reasons for performing the MVC:s without the wire electrodes. Firstly, possible damage to the wire electrodes during MVC was avoided, and secondly, the discomfort from the wires, especially right after the insertion, would possibly have affected the MVC-measurements.

d-f) Stretches in passive and active conditions

Measurement consisted of rapid 4 deg. (0.07 rad) dorsiflexions of the ankle joint at isometric (ISO), lengthening (LEN) and shortening (SHO) pre-conditions (Fig. 5). Each stretch was evoked at the same ankle joint angle (zero position, $103.1 \pm 1.9 \text{ deg}$). Both passive and active stretches were used. The three stretching velocities used were 70, 120 and $200 \text{ deg} \cdot \text{s}^{-1}$ ($1.22, 2.09$ and $3.49 \text{ rad} \cdot \text{s}^{-1}$).

In passive conditions the subject was told to relax his calf muscles completely and to remain relaxed throughout the movement. In the active conditions the subject first produced the desired force level while the pedal was stable at the zero position. To achieve this, subject received visual feedback from an oscilloscope. The subject was then instructed to hold the same level of muscle activity throughout the following movement. Subject was not allowed to look at the oscilloscope during the movement. This was done to prevent the subject from being disturbed by the fluctuations in force,

caused by the pedal movements. A loudspeaker was connected to one of the wire-electrodes in order to help the subject in maintaining steady activity.

In one ~30 s recording period, three stretches were elicited, one of each precondition (Fig. 6.). A voluntary isometric ramp contraction to 50% MVC was performed before and after each set of (three) stretches. This was done for the wire electrode measurements not reported here. Pedal movements in different preconditions (ISO, SHO, LEN) are illustrated in Fig. 5. First the pedal was rotated from zero position to the starting position of the first stretch at an angular velocity of $60 \text{ deg} \cdot \text{s}^{-1}$ (Fig. 5, a). The velocity was chosen to be low enough not to evoke a stretch reflex but fast enough to enable the required response period (1s) after the stretch (the software used for pedal movement programming limited the length of each individual stretch sequence to 5 s). After moving to the starting position the pedal remained in the steady position for a time period of 3 to 4 seconds (b). This period was needed to relax the muscle in passive stretches, and to restore the desired level of muscle activity in the active conditions. After the steady period, the pedal moved dorsally (LEN), plantarly (SHO), or not at all (ISO) to the zero position ($103.3 \pm 1.8 \text{ deg}$) at a velocity of $30 \text{ deg} \cdot \text{s}^{-1}$ (c), where the stretch (d) was applied. After the stretch, the pedal remained stable for a minimum time of 1 s (e) to enable a full stretch response. In the active stretches, subject was instructed to keep the desired level of activation also during this period. After this, the platform was returned to the zero position in 57.1 ms ($\omega = 70 \text{ deg} \cdot \text{s}^{-1}$) (f) and another stretch movement begun. Each stretching sequence was repeated three times. The order of stretches was randomized between subjects, but not within a subject. This made it easier for a subject to keep the desired level of activity throughout sequence. The minimum time interval between two successive stretches was 5 s. Approximately 1 min was given between stretch-sequences to avoid fatigue.

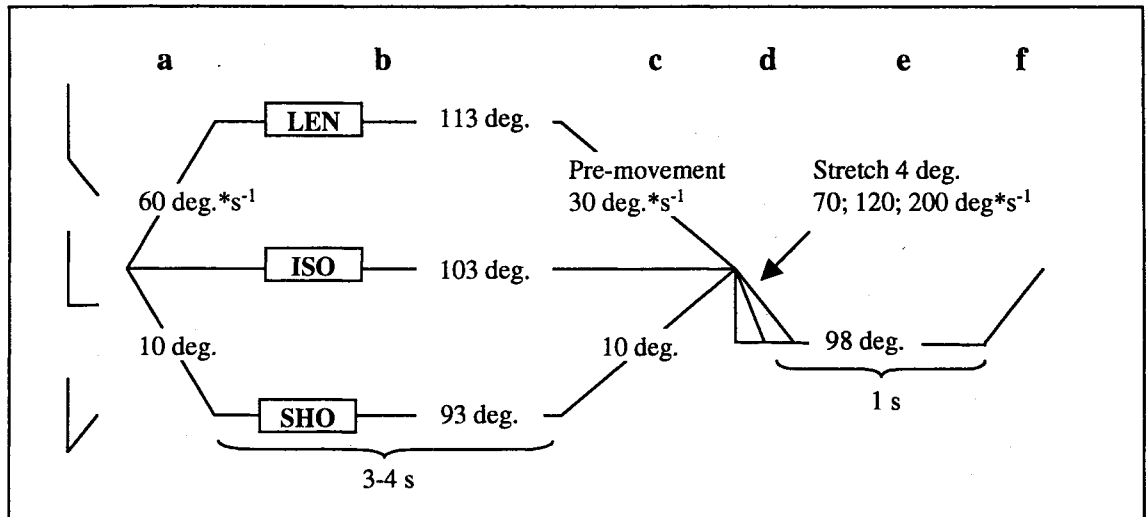

Figure 5. Pedal movement during different pre-conditions. Movement to starting position (a); a stable period (b) before pre-movement (c) to zero-position. A stretch at three different velocities (d), followed by a stable period (e). Finally the pedal moved back to the zero-position (f).

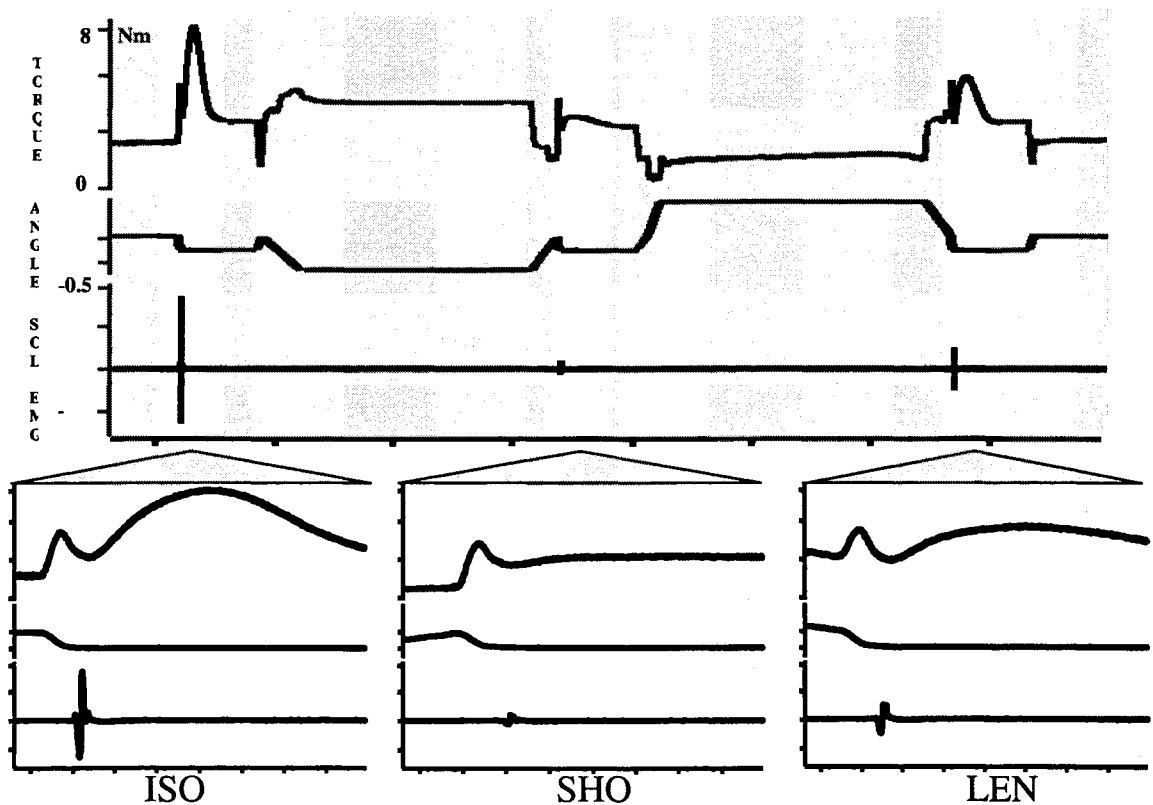

Figure 6. An example of a recording sequence at velocity of $120 \text{ deg} \cdot \text{s}^{-1}$. Each sequence consisted of three stretches one of each precondition (ISO, SHO, LEN). The order of stretches was randomized between subjects. The time interval between stretches was ~ 5 s.

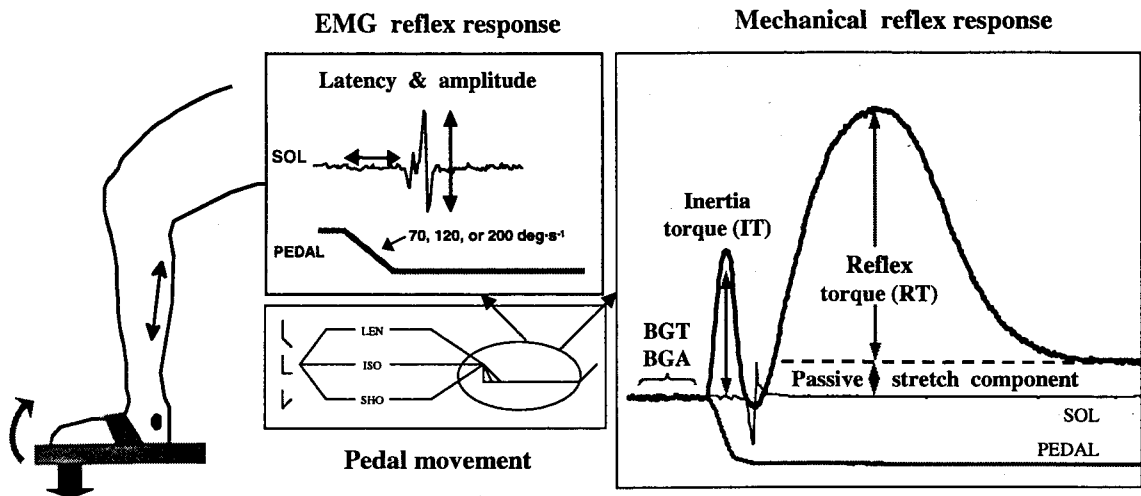

Figure 7. A schematic diagram of EMG- and Torque analysis. EMG reflex response was analyzed for SLR latency and amplitude. From the torque data, inertia (IT) and reflex-induced torques (RT) were analyzed. Passive stretch component was measured from the torque after the end of RT. Background activity (BGA) and torque (BGT) were analyzed from a period of 100 ms before the beginning of the stretch.

h) MVC₂

Another set of maximal contractions was performed after the stretch measurements to evaluate the possible fatigue effects induced by the protocol. Measurements were identical to MVC₁.

4.3 Apparatus

In the measurements, rotations about the right ankle joint were elicited. For this purpose, subject was strapped to a motor driven ankle dynamometer. This apparatus is controlled by a digital feedback system and is similar to that used by Gollhofer & Schmidtbleicher (1989). The maximum torque capacity of the machine is 150 Nm. The angular movement of the ankle joint with respect to the plane of the ergometer is monitored by a linear potentiometer and the moment by piezoelectric crystal transducer (Kistler, Switzerland). The torque and angle signals were collected into a computer via a CED 1401+ (Cambridge Electronic Design) with a sampling frequency of 1 kHz.

Signals were analyzed using the Spike2 software (Cambridge Electronic Design). Before analysis torque and angle signals were filtered with a low-pass filter (cutoff frequencies 75 and 150 Hz, respectively).

To maximize stability in measurements around the ankle joint, the subject was strapped to the chair from thigh and ankle. The rotational axis of device was in line with the axis of tibio-tarsal joint. The range of ankle joint motion during the measurements was 10 deg. (0.17 rad) dorsiflexion and plantarflexion from the initial position (103.3 ± 1.8 deg.). Other lower limb joint angles were fixed to 137.4 ± 2.8 deg. (knee) and 119.3 ± 9.9 deg. (hip).

Muscle activities of Soleus (SOL) and Gastrocnemius medialis (GM) were measured with surface electrodes. The activity of SOL was also recorded with wire electrodes, but only the data from surface electrodes is reported here.

Bipolar surface electrodes (Beckman 650437) were used. According to the recommendation by SENIAM (1999), a 20 mm inter-electrode distance was employed. A constant inter-electrode distance was ensured by using a special plastic housing into which the electrodes were built. The electrodes were placed longitudinally on the right leg, ~6 cm above the superior aspect of the calcaneus on the soleus muscle and between the center of the innervation zone and distal end of the lateral head of the gastrocnemius muscle. The skin under the electrodes was abraded and cleaned with alcohol to reduce the inter-electrode resistance below 5 k Ω . The EMG signals were transmitted telemetrically (Medinic AB model 1C-600-G, Sweden) and collected into a computer via a CED 1401+ (Cambridge Electronic Design) with a sampling frequency of 1 kHz. The EMG signals were filtered (high-pass filter; cutoff frequency 50 Hz) and analyzed using the Spike2 software (Cambridge Electronic Design).

4.4 Analysis

4.4.1 MVC

The MVC measurements were analyzed in terms of SOL EMG activity and plantar flexion torque. Maximal activity was measured as the RMS value from a period of 100 ms. In ISO the measurement was done by placing a 100 ms window that began 50 ms prior to the peak moment. In CON & ECC the beginning of the window was placed 100 ms before the end of the stretch. The torque values for ISO were calculated as the largest 100 ms mean. In CON and ECC the torque was measured as the mean 100 ms before the pedal reached zero level.

4.4.2 Stretch measurements

Background activity (BGA) was measured as the root mean square (RMS) 100 ms before the stretch onset and presented as percentages of the activity during MVC (Fig. 7). Reflex latency was calculated as the time interval between the beginning of the stretch and the appearance of the short latency stretch reflex EMG response (SLR). SLR onset and ending were identified according to the method by Lee and Tatton (1978). The beginning of SLR was identified by a consistent rapid increase of activity approximately 40 ms after the onset of stretch. The end of the second response spike about 15-20 ms later marked the end of SLR. The response peak-to-peak amplitude and duration were calculated using these parameters.

Torque analysis was only made to data recorded in passive conditions due to large variations in the active torque data (see Discussion for details). From the torque signal, the following values were measured (Fig. 7): 1) Background torque (BGT) as a mean 100 ms before stretch onset. 2) Inertia torque (IT) after the end of pedal movement. This value was measured from the point where the pedal deceleration reached its maximum. 3) Maximal reflex-induced torque (RT) was calculated both as an absolute value and by subtracting passive level values from moment values. The level values were calculated as the average of the subject's passive trials.

Each set of stretches was performed to both passive and active muscle. The active stretches were performed with two submaximal levels of activity, calculated as percentages of RMS value during maximal isometric contractions. The two levels used were 10 and 20% MVC. During analysis the data from two levels of activity were combined (see Discussion for details).

4.5 Statistics

Repeated measures of analysis of variance (MANOVA) was used to test for significant differences between conditions. When significant difference was detected, Bonferroni t-test was used to locate the specific differences. The level of significance accepted was $P < 0.05$.

5 RESULTS

5.1 MVC

Maximal voluntary contractions were performed before and after the measurements. The mean values of both torque and EMG RMS were somewhat decreased, but the changes were not significant excluding the difference in eccentric SOL RMS between MVC₁ and MVC₂ (Table 1)

	MVC ₁		MVC ₂	
	SOL RMS	Torque (kg/m)	SOL RMS	Torque (kg/m)
ISO	0.24±0.08	69.36±24.38	0.17±0.17	55.42±30.72
CON	0.26±0.07	59.42±25.25	0.16±0.18	42.76±29.54
ECC	0.25±0.07	83.84±19.52	0.16±0.10	62.67±36.30

Table 1. Results of the MVC measurements before (MVC₁) and after (MVC₂) the protocol (Mean ± SD). The differences between stretching conditions (ISO, CON, ECC) or pre- and post-measurements are not statistically significant except for eccentric SOL RMS between MVC₁ and MVC₂ (P<0.05).

5.2 Passive stretches

Muscle activity was measured from soleus (SOL) and medial gastrocnemius (MG) muscles, but only the data from SOL was analyzed. This was due to device malfunctions and the fact, that MG is much less sensitive to stretching (see Discussion for details). Therefore the response in the detected signals varied greatly.

In LEN the pedal rotated to zero position with a velocity of 30 deg· s⁻¹ (0.52 rad· s⁻¹). This did not evoke a stretch reflex in any of the subjects. As predicted, in SHO the torque decreased during the movement preceding the stretch, whereas in LEN it increased. Thus, the measured torques at stretch onset, were significantly different (P<0.05) between different pre-conditions (Fig. 11). Largest torque at stretch onset was

in LEN and smallest in SHO. Increasing stretching velocity increased the torque at the end of stretch in ISO and in LEN. Reflex torques were calculated in both absolute and net values (= reflex component – passive component, see Fig. 7.), but no differences were found in the behavior of the two. Thus only absolute values are presented here.

Results concerning the passive stretches are summarized in Table 2A. Peak-to-peak amplitude of the soleus EMG stretch reflex response was considerably larger in ISO than in either of the dynamic preconditions in all of the stretching velocities (Fig. 8). The amplitude in ISO was more than double the size of LEN ($P < 0.001$) and approximately five times that of SHO ($P < 0.001$). This was accompanied by a total absence of responses in some subjects. With the slowest stretching velocity ($70 \text{ deg} \cdot \text{s}^{-1}$), only one of the 8 subjects showed a measurable reflex response in SHO and only 5 in LEN. Naturally no further activation-related changes could be analyzed in SHO with this velocity. Voluntary activation and an increase in stretch velocity increased the probability of reflex occurrence. The smaller EMG responses in dynamic (SHO & LEN) pre-conditions were accompanied with significantly smaller torque responses compared to ISO (Fig. 11). Stretch reflex increased the torque significantly above the level measured at the end of pedal movement only in ISO ($P < 0.05$).

An increase in the stretching velocity in passive muscle increased the EMG-response in ISO and LEN; SLR amplitude was doubled from the slowest ($70 \text{ deg} \cdot \text{s}^{-1}$) to the highest ($200 \text{ deg} \cdot \text{s}^{-1}$) velocity. Velocity-related changes were more modest in the reflex-induced torque. In SHO no changes were observed in EMG or torque response between different velocities.

In passive muscle, SHO reflex latency was significantly longer compared to other preconditions ($P < 0.001$) and this difference decreased with increasing velocity. In ISO the longest latency was found with slowest stretching velocity. No differences were found in reflex duration between velocities or conditions.

Table 2. SLR parameters in A) passive and B) active conditions. *= Only one subject showed reflex activity. BG-torque = background torque, Rfx = reflex

A		Latency (ms)	Duration (ms)	Amplitude (mV)	BG-torque (Nm)	Inertia-torque (Nm)	Rfx-torque (Nm)
Len	70	35.99 ± 4.80	14.38 ± 3.03	0.22 ± 0.05	3.04 ± 0.73	3.50 ± 0.66	3.47 ± 0.66
	120	37.92 ± 4.70	13.65 ± 2.18	0.31 ± 0.19	2.89 ± 0.36	4.00 ± 0.47	4.01 ± 0.44
	200	39.42 ± 3.98	14.47 ± 1.80	0.55 ± 0.40	2.89 ± 0.40	4.36 ± 0.46	5.00 ± 1.08
Iso	70	47.09 ± 7.26	15.80 ± 2.17	0.60 ± 0.40	1.75 ± 0.40	3.88 ± 0.48	5.70 ± 1.67
	120	41.34 ± 3.21	15.51 ± 3.20	0.85 ± 0.38	1.73 ± 0.48	4.15 ± 0.53	6.66 ± 1.56
	200	40.76 ± 2.82	15.49 ± 3.23	1.52 ± 0.58	1.75 ± 0.45	4.20 ± 0.50	7.88 ± 1.78
Sho	70	*					
	120	56.38 ± 6.21	14.79 ± 2.70	0.18 ± 0.10	0.80 ± 0.42	3.46 ± 0.44	3.47 ± 0.89
	200	47.90 ± 4.59	13.54 ± 1.50	0.27 ± 0.19	0.83 ± 0.42	3.47 ± 0.41	3.90 ± 1.42

B		Latency (ms)	Duration (ms)	Amplitude (mV)	BGA (%MVC)
Len	70	35.53 ± 1.67	14.04 ± 1.12	0.66 ± 0.19	17.76 ± 3.45
	120	37.64 ± 7.62	14.88 ± 2.41	0.88 ± 0.26	18.75 ± 2.75
	200	36.55 ± 2.53	14.31 ± 3.09	0.81 ± 0.20	16.26 ± 5.04
Iso	70	38.73 ± 2.03	15.38 ± 4.13	0.69 ± 0.23	17.24 ± 4.25
	120	38.60 ± 2.78	16.18 ± 2.36	1.12 ± 0.31	17.01 ± 3.53
	200	38.79 ± 2.87	14.74 ± 2.01	1.41 ± 0.38	18.33 ± 3.51
Sho	70	39.68 ± 3.53	18.27 ± 3.52	0.64 ± 0.12	17.34 ± 3.47
	120	38.81 ± 3.66	17.18 ± 1.68	1.06 ± 0.43	15.14 ± 1.98
	200	38.40 ± 2.93	16.16 ± 1.53	1.49 ± 0.57	15.97 ± 2.93

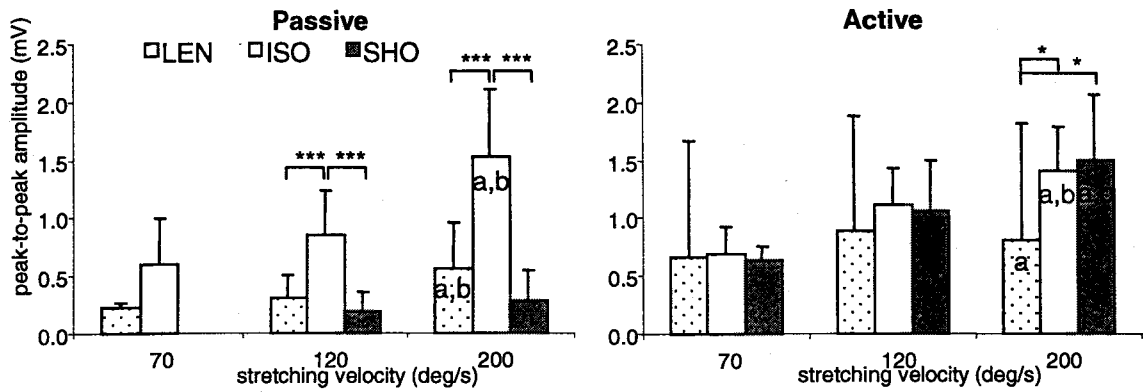

Figure 8. Peak to peak amplitudes of SLR in passive and active muscle. * = significant difference between pre-conditions (* P < 0.05; ** P < 0.01; *** P < 0.001). a = significantly different from 70 deg· s⁻¹, b = significantly different from 120 deg· s⁻¹. Note the absence of results in passive SHO with slowest velocity (see text for details).

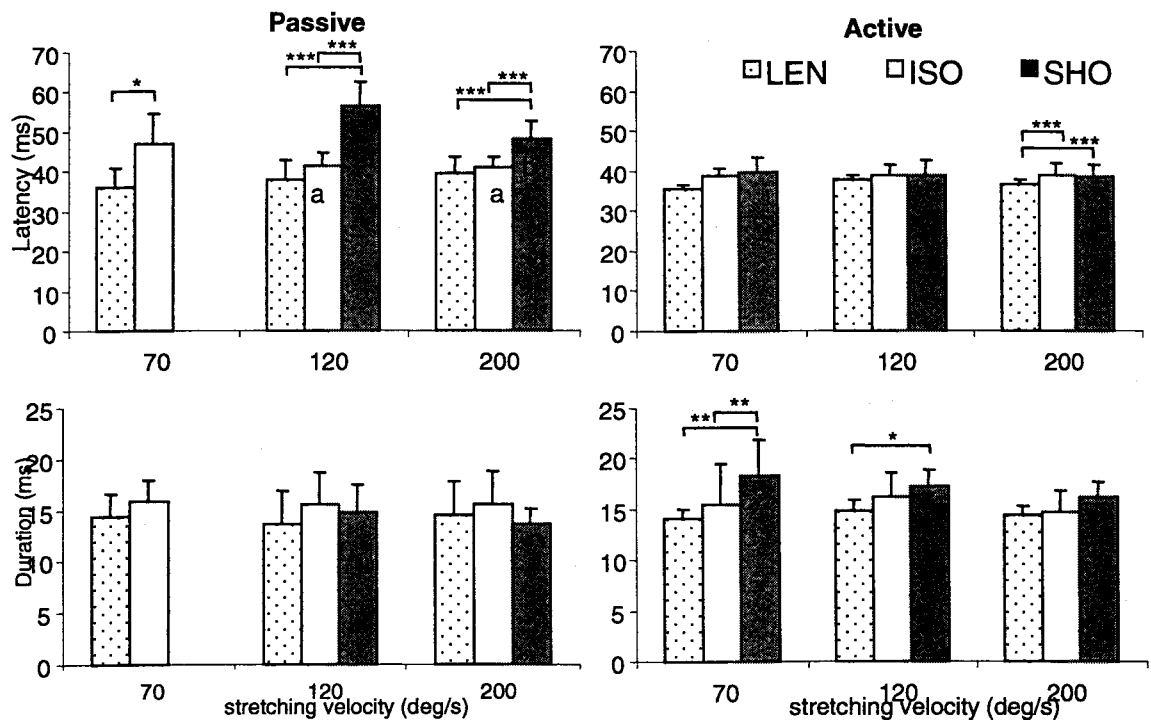

Figure 9. SLR latency and duration in passive and active muscle. * = significant difference between pre-conditions (* P < 0.05; ** P < 0.01; *** P < 0.001). a = significantly different from 70 deg· s⁻¹, b = significantly different from 120 deg· s⁻¹. Note the absence of results in passive SHO with slowest velocity (see text for details).

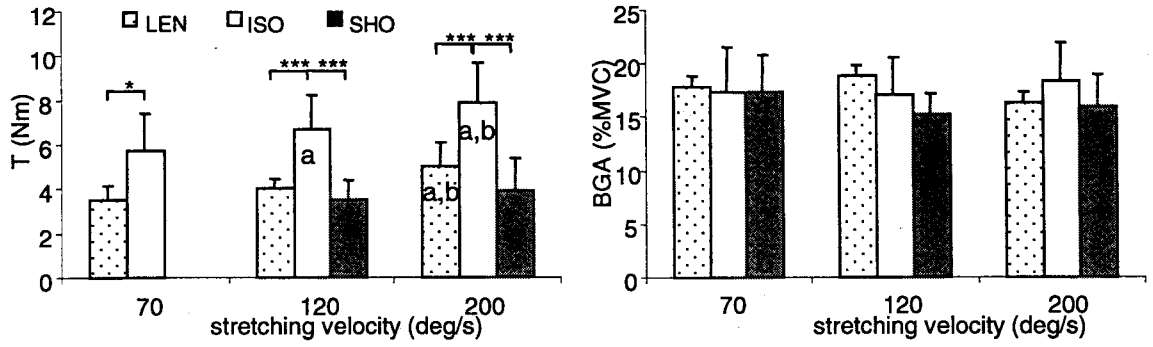

Figure 10. Reflex-induced torque (top) in passive muscle and background activation in active trials (bottom). * = significant difference between pre-conditions (* P < 0.05; ** P < 0.01; *** P < 0.001). a = significantly different from 70 deg· s⁻¹, b = significantly different from 120 deg· s⁻¹. Note the absence of results in passive SHO with slowest velocity (see text for details).

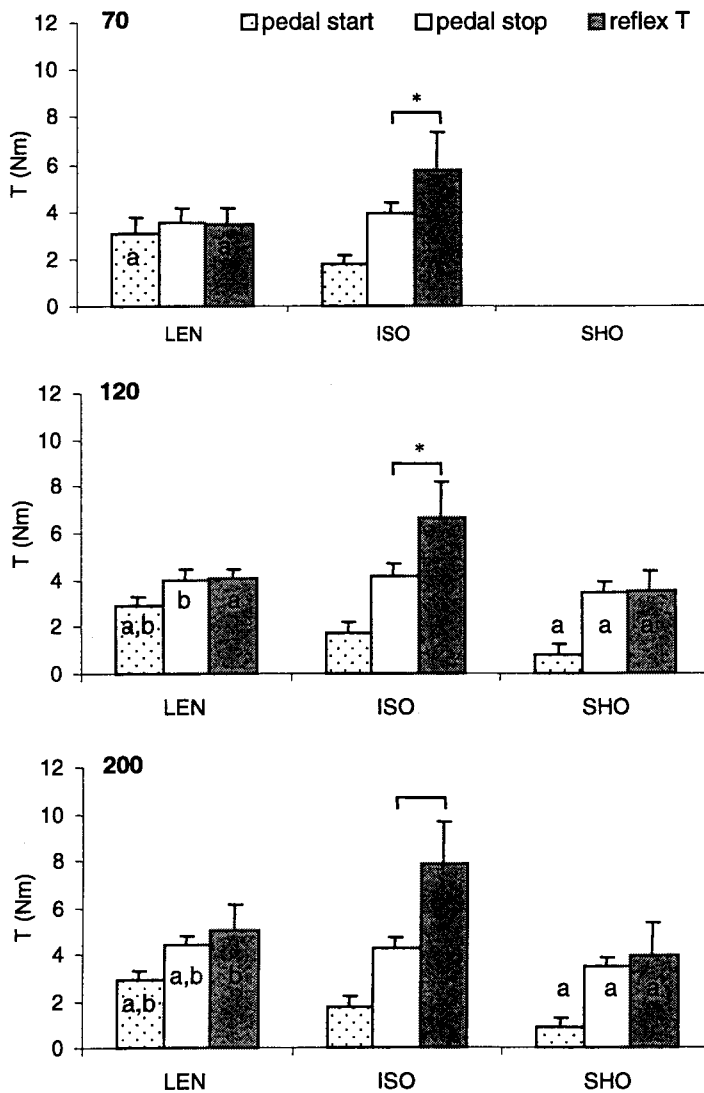

Figure 11. The development of torque during a stretch in passive muscle. * = significant difference between phases (P < 0.05), a = significantly different from ISO, b = significantly different from SHO. Note the absence of reflex responses in passive SHO with slowest velocity (see text for details).

5.3 Stretches with activation

In the measurements two different activation levels were used in addition to passive stretches. However, subjects had difficulties in maintaining the desired level of activation, which led to variations in the background activation (BGA) between trials. Therefore data from the two active levels were combined to one group including trials with a BGA between 15-25 % MVC (see Discussion for details).

In the active measurements, like in passive condition, torque decreased in SHO during the movement preceding the stretch and increased in LEN. Largest torques at stretch onset were measured in LEN and smallest in SHO. Absolute values and significant differences between conditions are presented in Table. 3. In most trials with activity, the reflexly induced torque could not be detected from the total torque. Therefore torque data was not analyzed for the reflex period. An example of a set of active trials is illustrated in Fig. 12.

The most evident change in reflex patterns compared to the passive trials was the large increase in reflex EMG amplitude in dynamic pre-conditions (Fig. 8). SHO peak-to-peak amplitude was over five times larger than in passive conditions ($P < 0.01$) and did not differ from ISO in any of the velocities used. Also the number of subjects with detectable reflex activity in $70 \text{ deg} \cdot \text{s}^{-1}$ increased from one to eight. The increase in LEN was not quite as dramatic and the difference compared to passive conditions decreased with increasing stretch velocity. In ISO activation did not cause significant increases in SLR in any of the measured velocities; In fact, SLR amplitude in active $200 \text{ deg} \cdot \text{s}^{-1}$ was smaller than in passive condition.

Amplitude in both ISO and SHO increased with velocity ($P < 0.01$) whereas in LEN no further increase was found from 120 to $200 \text{ deg} \cdot \text{s}^{-1}$. Latency decreased significantly in LEN ($200 \text{ deg} \cdot \text{s}^{-1}$) SHO (120 and $200 \text{ deg} \cdot \text{s}^{-1}$) and ISO (all velocities) as compared to the passive condition. In SHO duration increased with activity.

Table 3. Torques at stretch onset and end of stretch in active condition. Significant differences ($P < 0.05$) between torques in different pre-conditions are displayed on the right ($<$ = significantly smaller than).

Velocity	SHO	ISO	LEN	Significant differences
Stretch onset				
70	9.1±4.6	15.3±5.3	14.6±2.6	SHO<ISO, LEN
120	8.5±2.8	14.2±3.4	19.1±7.9	SHO<ISO<LEN
200	9.2±3.1	16.1±5.3	21.2±8.1	SHO<ISO<LEN
Stretch end				
70	14.2±5.3	20.9±6.1	16.7±3.5	SHO<ISO
120	12.1±3.0	18.6±3.8	21.1±8.5	SHO<ISO, LEN
200	12.3±3.2	19.8±5.6	23.9±8.9	SHO<ISO<LEN

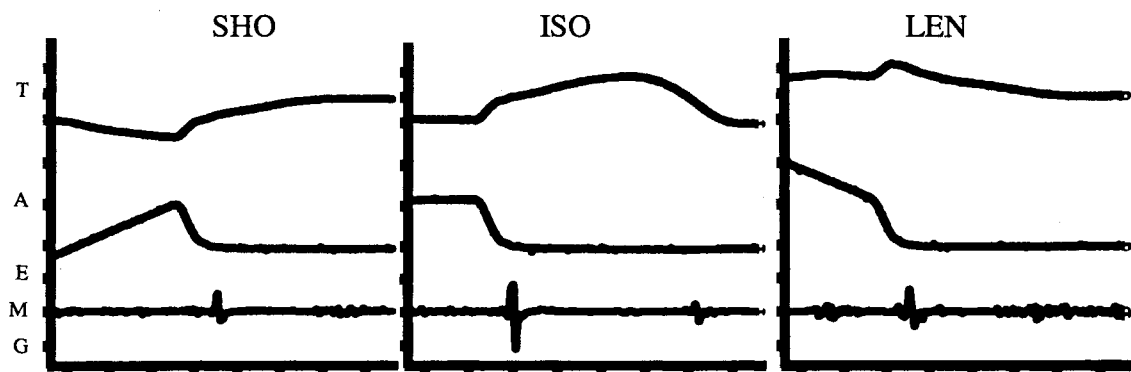

Figure 12. Typical examples of stretch response with voluntary activation. Despite a visible reflex response in EMG, a clear reflex-induced response in torque can only be seen in ISO condition.

6 DISCUSSION

The main findings of the study were as follows:

1. Stretching a passive muscle evoked larger SLR amplitudes in isometric (ISO) condition compared to dynamic conditions (SHO, LEN).
2. In active muscle, no difference in SLR amplitude was observed between ISO and SHO.
3. With highest stretching velocity SLR amplitude was smaller in LEN compared to ISO or SHO.

6.1 Level of activation

When comparing reflex responses to perturbations in different active situations the level of effort at stretch onset should be considered. It is well known that the relationship between muscle tension and activity differs between isometric, concentric and eccentric muscle actions (Komi 1973). Therefore, determining the level of effort as torque at stretch onset is bound to lead to different activity levels between different modes of muscle work and visa versa. Both torque (Nagazawa et al. 1998; Ogiso et al. 2002) and activity levels (Nagazawa et al. 1998) have been used in previous studies. In the present study we used the RMS value from 100-0 ms before stretch onset as the determinant of background activity. Another method, recently used by Ogiso et al. (2002a), would have been to measure the level of activity between the stretch onset and the beginning of the EMG response. Nakazawa et al. (1997a) compared the signals which were measured 100 ms before the stretch and during an undisturbed movement through the stretch region. No significant differences were found between the two.

In the present study, each recording sequence consisted of three stretches, one of each precondition (ISO, SHO, LEN). The order of stretches was randomised between subjects, but not within subjects. Therefore, the subject always “knew” what to expect during the sequence. This method was chosen to help the subject in maintaining the desired level of activation during the active stretches. It might be argued, that the knowledge of the timing of the stretch onset could have affected the results. It should, however, be noted, that during the dynamic preconditions the subject knew the onset of

stretch from the pedal movement. Therefore, only ISO situation could have been made unexpected by varying the order of stretches. It has, however, been reported, that the short latency stretch reflex responses are not different in conditions where the perturbation is unexpected compared to expected ones (Crago et al. 1976; Smeets et al. 1995; Aminoff & Goodin 2000).

In the study by Ogiso et al. (2002a) two levels of activity were used as well. Although the desired levels of activity (measured in torque) differed by 20 percentage units (30 and 50% MVC), no significant difference were found between the means of the two measured levels of activity at stretch onset. Thus maintaining a pre-determined level of activity throughout the movements of different amplitudes and velocities appears to be quite a demanding task. In the present study, even though the order of pedal movements was not randomised, the level of activity at the stretch onset (BGA) varied between and within subjects. Since only three repetitions were made for each condition, excluding all the trials that differed from the predetermined activity levels would have markedly decreased the number of trials. In fact, in many occasions the measured activities at lower activity level (10% MVC) were higher than at the higher level (20% MVC). To solve this problem we combined the data from the two levels of activity to one group consisting of activity levels of 10-25% MVC. Before the combination we examined the effect of increasing activity (passive trials excluded) on reflex response magnitude, but no relationship was found in any of the velocities or preconditions used (Fig. 12).

In isometric conditions the reflex response has been reported to depend on background activation level (e.g. Matthews 1986). In some studies activation was found to increase the short latency reflex amplitude when compared to passive situation, whereas further activation did not increase the response proportionally in humans (Toft et al. 1991) or in decerebrate cats (Hoffer & Andreassen 1981a,b). In the study of Toft et al. (1991) independent behaviour was suggested to be a property of the soleus muscle, whereas activation dependency was found in the anterior tibial muscle (Toft et al. 1989). Another suggested reason was a possible saturation of the motoneuron pool, since the measured reflex peaks were comparable to the activities measured during maximal contractions (Toft et al. 1991). Also in the present study, the largest reflex peaks corresponded to the EMG amplitudes obtained in isometric, concentric and eccentric MVC measurements.

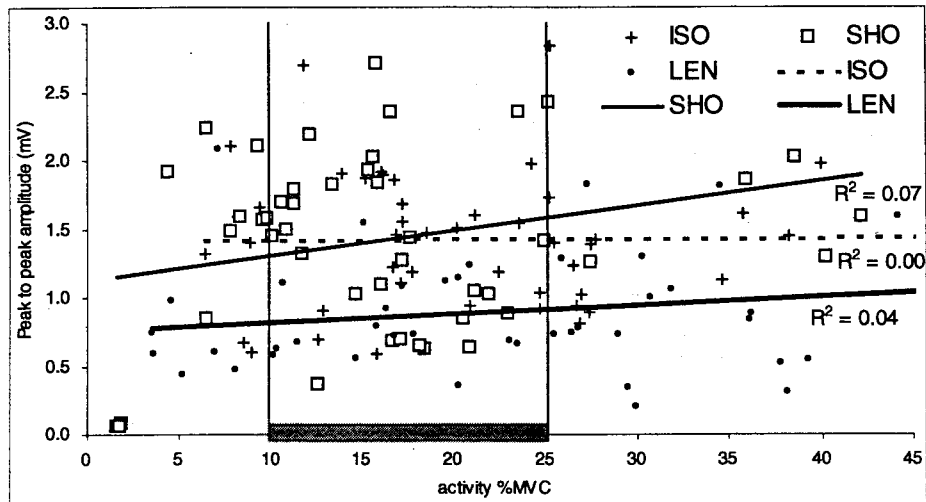

Figure 12. The relationship between the level of activation and reflex amplitude at stretching velocity $200 \text{ deg} \cdot \text{s}^{-1}$. (passive trials not included). Grey bar indicates the chosen range of activity.

6.2 Torque in trials with activation

Figure 12 shows typical examples of stretch reflex responses in active preloading situations. As can be seen, torque curves do not follow a typical biphasic curve with the initial inertia torque being followed by a reflex induced torque increase. In most trials in LEN, no reflex-induced torque could be detected even though the EMG response was clearly visible. For these reasons we had to exclude torque data from the active trials.

One of the reasons for the observed behaviour of torques during active trials could be the position of the subject. Stretch reflex is stronger when muscles are stretched in a longer position (Fellows & Thilmann 1989; Stein & Kearney 1995). We attempted to measure the muscle activities of both SOL and MG in the study, and since MG is a biarticulate muscle, we adjusted the dynamometer in a position, where knee was less flexed ($137.4 \pm 2.8 \text{ deg}$), thus stretching the MG muscle. The EMG response of MG was nevertheless quite unstable and the responses were not included in the results. MG has been found to be less sensitive to stretch (Nardone et al. 1990, Voigt et al. 1998), possibly due to the larger proportion of fast (type II) muscle fibres or smaller density of muscle spindles (Voss 1971). In earlier studies in our laboratory (e.g. Ogiso 2002a,b)

we have been able to successfully measure reflex torques in active stretching conditions, but with somewhat smaller knee angles (131 ± 7 deg. in Ogiso et al. 2002b).

There is also another possible reason for the small reflex responses during the active stretches. In the study, the subject was instructed to maintain a constant level of activity throughout the movement. Subject received audio feedback from a loudspeaker attached to a wire-electrode in the soleus muscle. It is apparent, that in most cases the reflex response caused the subject to decrease the neural drive to the muscles during the immediate time period following the reflex response. This decreased activation would thus decrease the torque response.

6.3 Mechanisms affecting reflex parameters

The current data supports earlier findings on SLR dependence on muscle history (Nakazawa et al. 1997a, Nakazawa et al. 1998, Ogiso 2002a,b). In passive muscle SLR in ISO is larger than in SHO or in LEN, whereas with preactivation SLR's in ISO and SHO are both larger than in LEN. What could be the underlying mechanism? The explanations for the observed differences can be located to two parts of the neuromuscular system: the motoneuron pool and the receptors. The amount efferent activation from the motoneuron pool is determined by the net effect of facilitatory and inhibitory input. Due to different preactivation types, the state of motoneuron pool can be different and thus the same afferent signal can evoke different activity to α -motoneurons. On the other hand, changes may also be caused by differences in the mechanical input to the facilitative or inhibitive receptors. This classification is somewhat arbitrary, because the changes in the motoneuron pool may be caused by afferent feedback from receptors. It should therefore be considered mainly as figurative. Few possible mechanisms are discussed in the next two chapters.

6.3.1 Changes in motoneuron pool

It has been suggested, that the different types of muscle activity preceding the stretch may change the activation pattern and that this might change the α -mn sensitivity to afferent input (Romano & Schieppati 1987). It has been reported, that selective recruitment of fast-twitch motor units exists during eccentric contractions (Romano & Schieppati 1987; Nardone et al. 1989; Abruzzese et al. 1994; Nagazawa et al. 1997,). These MU's are less sensitive to stretch, which has been proposed as the reason for the observed decrease in H-reflex during eccentric contractions (Nardone & Scieppati 1987). It should be noted, that there are some differences between H- and stretch reflexes that may affect the results. It is, however, possible, that the same mechanism would explain the decreased SLR amplitudes in LEN in active trials. This is supported by the finding that compared to concentric or isometric situation, H-reflex is more depressed in eccentric contractions especially with high stretching velocities (Romano & Schieppati 1987). Also in present study the difference in SLR amplitude between LEN and other pre-conditions increased with increasing stretching velocity.

6.3.2 Proprioceptors with facilitatory and inhibitory responses

External mechanical disturbances affect facilitative sensors, such as muscle spindles and the cutaneous receptors, and the inhibitive sensors, like the Golgi tendon organ. The spindle is a very complicated receptor and it is very difficult to estimate it's response to external disturbances in different situations. Basically spindles respond to two different types of stimuli; extrafusal length changes that either slacken or stretch them, and fusimotor activation that stretches the receptor-side by contracting the poles of the intrafusal fibers. Activation of γ -motoneurons increases the dynamic index of the spindles, thus making it more sensitive to changes in muscle length.

Many of the proposed mechanisms explaining the differences between SLR amplitudes are based on a phenomenon called muscle thixotrophy. The existence of muscle thixotrophy has been reported in numerous papers (for review, see Proske et al. 1993). It was first observed by Hill (1938) and named "short range elastic component", and has later been shown to result from spontaneous formation of long lasting cross-bridges in

passive muscle. These bridges form in 1-3 seconds and are broken by voluntary contraction or large amplitude movement. Thixotropy is believed to be the mechanism behind the so-called short-range stiffness. Similar formation has also been observed in intrafusal fibres. (for review, see Proske et al. 1993.)

Intrafusal stiffness. Baumann & Hulliger (1991) suggested movement-induced decrease in intrafusal stiffness as the reason for the observed decrease in Ia afferent response to stretch. Stiff intrafusal fibres expose the sensory regions of spindle to greater proportion of the external stretch (Hasan & Houk 1975). During movement long-lasting intrafusal cross-bridges will break down, which decreases this stiffness, and therefore decreases afferent activation. In the present study stretches imposed to passive muscle in ISO resulted in larger amplitude SLR than in dynamic conditions.

Intrafusal slack. Another proposed mechanism based on intrafusal thixotropy was first introduced by Gregory et al. (1987). When passive muscle shortens, the long-lasting intrafusal cross-bridges remain attached, thus slackening the central, afferent, part of the spindle (for review, see Proske et al. 1993). The slackening of the spindle decreases the amount of excitatory afferent activity and results in disfacilitation of the motoneuron pool. This mechanism can be studied by shortening a muscle after a contraction, and then subjecting it to a stretch. If the stretch is not preceded by a "conditioning" contraction that resets the intrafusal fibers, the following response is significantly decreased. However, no conditioning effect is observed if the contraction is performed electrically, thus without activating fusimotor neurons (Gregory et al. 1998). Bawa & Sinkjaer (1999) proposed spindle unloading as the mechanism explaining the reduced SLR they measured during a tracking movement. This task corresponded to active pre-shortening (SHO) in present study. Here, as well as in the study by Ogiso et al. (2002a), no reduction in SLR amplitude in SHO was observed compared to ISO-situation during active shortening. This may indicate a difference between muscles or tasks. It could be argued, that the role of reflex control in supporting muscles, such as soleus is much more important than in wrist flexors. In the study by Bawa & Sinkjaer (1999) the task was to track a sinusoidal curve by alternately activating the wrist flexors and extensors. Thus, the activation patterns between studies were also different, because in the present study subject was instructed to maintain a constant level of activation.

Spindle slackening is supported by the observed longer latency in SHO compared to other preconditions in the present study, as well as in a previous study by Ogiso et al. 2002a. If the spindles are indeed unloaded, the beginning of the stretch is used to get rid of the slack, and the afferent activity is delayed. This mechanism is further supported by the fact, that the difference in SLR amplitude between SHO and other preconditions decreased as stretching velocity increased from 120°/s to 200°/s. With higher stretching velocity, the spindles are tightened faster. As fusimotor facilitation was increased by voluntarily activating the muscles the difference in reflex amplitude between SHO and ISO disappeared. In SHO SLR peak-to-peak values with voluntary activation were over five times greater than passive values in all of the stretching velocities. In addition, the number of subjects with at least one stretch reflex response (out of 3 repetitions) with the slowest stretching velocity (70°/s) increased from one to five (total N=8).

Spindle “loading”. Yet another possible explanation based on muscle thixotrophy could be presented. The following mechanism is based on the thixotropic “loading” of muscle spindles and may explain, at least partially, the reduced reflex amplitude in LEN. The mechanism is illustrated in Fig. 14. It should be noted that this phenomenon can only be present in passive muscle. The same mechanism might also exist in SHO, although spindle slackening seems more likely to be the main contributing factor in SLR reduction in such situation.

Isometric (ISO)

1. In passive ISO condition, the muscle was stretched without pre-movement after a stable period of 3.9 s. According to previous studies, this period is adequate for the formation of long-lasting cross-bridges (Gregory et al. 1998).
2. As the stretch begins (1), the existing cross-bridges in the contractile component resist the pull preventing the component from lengthening. The external length change causes the tendon to stretch. The sarcomeres “load”.
3. Once the cross-bridges break (3), the increase in velocity (acceleration) of the muscle fibers and, thus, the spindles in parallel with them, is larger than would have been without “loading”. If the drop in tension after the breaking point is large enough for the tendon to actually shorten, the acceleration in spindles could even exceed external peak acceleration.

Lengthening (LEN)

1. Large amplitude movement has been found to break the long-lasting cross-bridges. In this study, the amplitude of movement preceding the stretch in dynamic preconditions was 10 deg. (0.17 rad.). Thus it appears likely, that no long-lasting cross-bridges were present at stretch onset in LEN (1).
2. The lack of existing cross-bridges changes the movement of the tendomuscular complex from the mechanism described above. There is no loading of the spindles and the acceleration sensed in the spindles does not exceed the external acceleration. In fact, the interaction between viscous elements in the contractile component (see the "dashpot-element" D in Fig. 14) and the tendon may act to "buffer" the peak external acceleration. Viscous properties do not cause loading like the elastic elements in the cross-bridges, but rather function like a shock absorber.

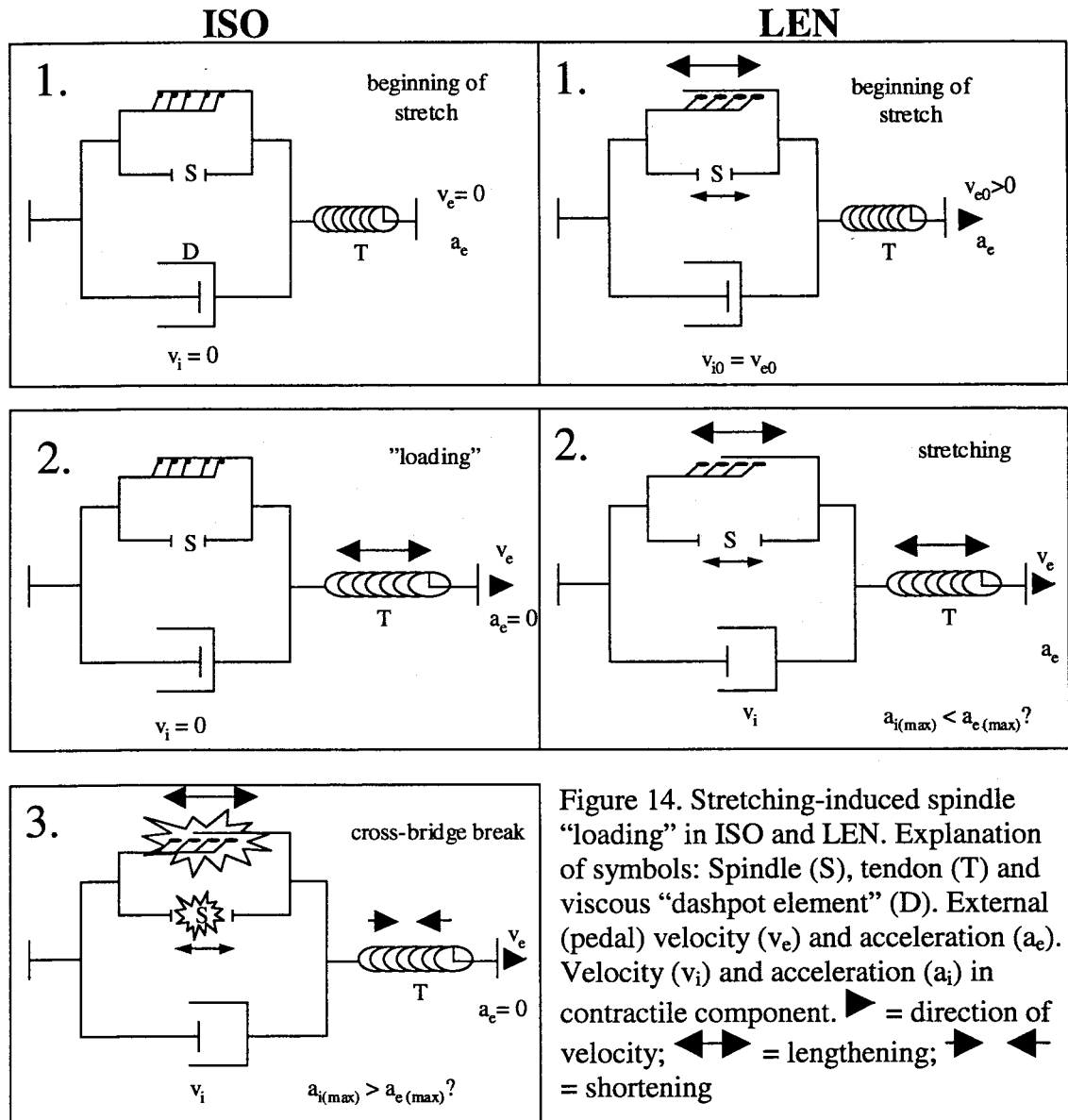

It should be noted, that muscle sarcomeres in series do not operate as a single unit; some may be stretched, while others contract (e.g. Morgan 1990). An additional complicating factor is the pennate muscle architecture. Thus there is no exact breaking point for the cross-bridges of all sarcomeres in a muscle. This mechanism may however explain the phenomenon partially. In our laboratory we have measured the fascicle behavior of Gastrocnemius muscle during stretches utilizing ultra-sound technique. Data, once analyzed, may bring new light to this clearly complicated phenomenon.

Golgi inhibition. For a long time Golgi tendon organ was considered to act only as an emergency sensor that was activated at force levels high enough to cause increased risk

of injury. However, tendon organs have been found to respond to forces less than 0.1g when directed to the base of the capsule (Houk et. al. 1971). Due to its tension-sensitive nature, the organ seems to be more sensitive to stretch caused by voluntary activation than to passive stretch. This could explain the following results in the present experiment:

- a) Voluntary activation increased SLR in SHO to the same level as in ISO. Reflex amplitude increased also in LEN, but –unlike in ISO and SHO – no further increase was observed when velocity increased from 120 to 200 deg· s⁻¹.
- b) Activation did not cause significant increases in reflex amplitude in ISO at any of the measured velocities.

It could be hypothesized that the increased tension during active stretching conditions increased the inhibition from Golgi in ISO and LEN conditions. In SHO the increased γ -input prevented the spindles from slackening, resulting in a large increase to the same amplitude-level as in ISO. In previous studies, also the inhibition from II-afferents and joint receptors has been considered (Ogiso et al. 2002a).

Muscle viscosity One possible explanation to the smaller reflex response in passive SHO compared to ISO situation could lie in the viscous properties of the muscle. As muscle is shortened in passive condition, viscosity in the contractile component of the muscle causes tendon slackening, and thus lag between fascicle and external length change (for illustration of the muscle model, see Fig. 14). When pedal direction is changed abruptly, tendon slack may delay the stretch and buffer the pedal acceleration.

6.4 Applications to locomotion

Two most important results of the present experiment where: a) in passive muscle, dynamic pre-conditioning results in lower stretch reflex sensitivity than in static situation (ISO) and b) in active muscle, the SLR is smaller than in ISO only after eccentric pre-conditioning (LEN). How can these phenomena be seen in human movement?

Doemges & Rack (1992a,b) investigated reflex activity in wrist and index finger flexion. No differences were found in SLR between two tasks: 1) constant position, varying force 2) constant force, varying position (dynamic movement). One explanation could be, that varying force in isometric condition elicits changes in the length of the contractile component of the muscle (Hill 1938). Therefore the situation, in spindle-point of view is not isometric, but dynamic. This would be in accordance with our results.

Drop jumps are used as a training method in many different sports that require speed and power of the ankle plantar flexors. There are two different techniques for performing drop jumps: plantar and dorsal technique. In the more traditional plantar technique ankle joint angle is stable before ground contact, whereas in dorsal technique contact is preceded by a rapid plantarflexion (Dolenec and Strojnik 1998). Plantar technique has been found to result in larger Achilles tendon forces, which indicates a greater imposed stress to the tendomuscular system compared to the dorsal technique (Dolenec and Strojnik 1998). In the present study SOL reflex amplitudes were not different after an isometric contraction (ISO) or active plantarflexion (SHO). This would suggest that the difference between the loading in the two techniques results from other factors than changes in reflex sensitivity. However, two distinctive differences exist between present study and drop jumps: firstly, preactivation in plantar technique is the result of cocontraction of dorsi- and plantarflexors, and secondly, the present study did not evaluate the possible contribution of Gastrocnemius muscles in stretches.

In conclusion, stretching a passive muscle evoked largest short latency reflexes in isometric precondition, whereas in active muscle, isometric or concentric pre-activation before stretch onset resulted in greater SLR amplitude than stretching during eccentric muscle action. These differences may be due to inhibition from Golgi afferents or mechanical changes at the spindle level.

YHTEENVETO

Venytystä edeltävän tilanteen on useissa tutkimuksissa havaittu vaikuttavan venytysrefleksiin (Nakazawa jne. 1997, 1998; Ogiso jne. 2002a,b). Tämän tutkimuksen tarkoituksena oli selvittää edeltävän lihastyötavan, aktivaation sekä venytysnopeuden vaikutuksia monosynaptiseen venytysrefleksiin (SLR).

Tutkimuksessa kohdistettiin nopeita venytyksiä koehenkilöiden (N = 8) oikean jalan kolmipäiseen pohjelihakseen passiivisissa ja aktiivisissa (10-25% MVC) tilanteissa. Venytystä ennen lihaspituus oli vakio (ISO), pieneni (SHO) tai kasvoi (LEN). Venytykset tehtiin aina samalla nilkkakulmalla. Käytetyt venytysnopeudet olivat (70, 120, 200 deg· s⁻¹).

Passiivisessa venytilanteessa Soleuksen refleksiampplitudi ja -voima olivat merkitsevästi (p<0.05) suurempia ISO-, kuin SHO- tai LEN-tilanteessa. Lisäksi hitaimmalla venytysnopeudella refleksivaste havaittiin vain yhdellä kahdeksasta koehenkilöistä SHO- ja viidellä LEN-tilanteessa. Voluntaariaktivaatio pienensi eroja dynaamisten ja ISO-tilanteen välillä. ISO- ja SHO-tilanteiden välillä ei havaittu merkitsevää eroa millään venytysnopeudella. LEN-tilanteessa venytysrefleksin amplitudi oli suurimmalla venytysnopeudella merkitsevästi pienempi (p<0.05) kuin ISO- tai SHO-tilanteissa.

Pienempi SLR-amplitudi ja pidempi latenssiaika passiivisessa SHO-tilanteessa johtuu ilmeisesti edeltävän liikkeen aiheuttamasta intrafusaalisolujen löystymisestä. Tätä oletusta tukee se löydös, että voluntaariaktivaatio pienensi SHO-tilanteen latenssiaikaa ja kasvatti refleksiampplitudin koon samalle tasolle kuin ISO-tilanteessa. Oletettavasti voluntaariaktivaation ohessa tapahtuva fusimotorinen aktiivisuus pitää spindelit herkkinä myös lihaksen lyhenemisen aikana.

Pienempi refleksiampplitudi LEN-tilanteessa saattaa olla seurausta muutoksista motoneuronialtaan herkkyydessä tai kasvaneesta Golgin jänne-elinten inhibitiosta. On myös mahdollista, että passiivisessa lihaksessa ISO-tilanteessa pitkäaikaiset poikkisillat

aiheuttavat spindeleissä ”latautumisen” jonka purkautuessa spindelin aistima venytys on suurempi verrattuna dynaamiseen esitilanteeseen.

REFERENCES

- Abbruzzese, G., Morena, M., Spadavecchia, L. & Schieppati, M. 1994. Response of arm flexor muscles to magnetic and electrical brain stimulation during shortening and lengthening tasks in man. *Journal of Physiology*. 481, 499 – 507.
- Aminoff, M.J. & Goodin, D.S. 2000. Studies of the human stretch reflex. *Muscle and Nerve*. Suppl 9:S3-6.
- Avela, J., Kyröläinen, H. & Komi, P.V. 1999a. Altered reflex sensitivity after repeated and prolonged passive muscle stretching. *Source Journal of applied physiology* 86, 1283 – 1291.
- Avela, J., Kyröläinen, H., Komi, P.V. & Rama, D. 1999b. Reduced reflex sensitivity persists several days after long-lasting stretch-shortening cycle exercise. *Journal of applied physiology* 86, 1292 – 300.
- Baumann, T.K. & Hulliger, M. 1991. The dependence of the response of cat spindle Ia afferents to sinusoidal stretch on the velocity of concomitant movement. *Journal of Physiology (Lond)* 439, 325 – 350.
- Bawa, P. & Sinkjaer, T. 1999. Reduced short and long latency reflexes during voluntary tracking movement of the human wrist joint. *Acta Physiologica Scandinavica* 167, 241 – 246.
- Bosco, C., Tarkka, I. & Komi, P. 1982. Effect of elastic energy and myoelectric potentiation of triceps surae during stretch shortening cycle exercise. *International Journal of Sports Medicine* 3, 137 – 140.
- Botterman, B.R., Binder, M.C. & Stuart, D.G. 1978. Functional anatomy of the association between motor units and muscle receptors. *Am. Zool.* 18, 135 – 152.
- Burke, R.E., Walmsley, B. & Hodgson, J.A. 1970. Structural-functional relations in monosynaptic action on spinal motoneurons, in Asanuma H, Wilson VJ (eds): *Integration in the nervous system*. Tokyo, Ikagu-Shoin, 27 – 45.
- Crago, P.E., Houk, J.C. & Hasan, Z. 1976. Regulatory actions of human stretch reflex. *Journal of Neurophysiology*. 39(5):925-35.
- Dietz, V. & Noth, J. 1978. Pre-innervation and stretch responses of triceps brachii in man falling with and without visual control. *Brain Research*. 142, 576 – 9.

Dietz, V., Discher, M. & Trippel, M. 1994. Task-dependent modulation of short- and long-latency electromyographic responses in upper limb muscles. *Electroencephalography and Clinical Neurophysiology*. 93, 49 – 56.

Dietz, V., Noth, J. & Schmidtbleicher, D. 1981. Interaction between pre-activity and stretch reflex in human triceps brachii during landing from forward falls. *Journal of Physiology*. 311, 113 – 25.

Dietz, V., Schmidtbleicher, D. & Noth, J. 1979. Neuronal mechanisms of human locomotion. *Journal of Neurophysiology*. 42, 1212 – 22.

Doemges, F. & Rack, P.M. 1992. Task-dependent changes in the response of human wrist joints to mechanical disturbance. *Journal of Physiology*. 447, 575 – 85.

Enoka, R. 1994. *Neuromechanical basis of kinesiology*. Champaign, IL. Human Kinetics.

Eng, J.J. & Hoffer, J.A. 1997. Regional variability of stretch reflex amplitude in the cat medial gastrocnemius muscle during a postural task. *Journal of Neurophysiology*. 78, 1150 – 4.

Fellows, S. & Thilman, A. 1989. The role of joint biomechanics in determining stretch reflex latency at the normal human ankle. *Experimental Brain Research* 77, 135 – 139.

Gollhofer, A. & Schmidtbleicher, D. 1989. Stretch reflex responses of the human m.triceps surae following mechanical stimulation. In: Gregor, R.J., Zernicke, R.F., Whiting, W.C., (Ed). *Congress Proceedings of the XII International Congress of Biomechanics. USA (Abstr)*, Los Angeles: University of California, 219-220.

Gollhofer, A., Strojnik, V., Rapp, W. & Schweizer, L. 1992. Behaviour of triceps surae muscle-tendon complex in different jump conditions. *Source European journal of applied physiology and occupational physiology* 64, 283 - 291.

Gottlieb, G.L. & Argaval, G.C. 1979. Response to sudden torques about ankle in man: myotatic reflex. *Journal of Neurophysiology* 42, 91 – 106.

Gregory, J.E., Morgan, L.D. & Proske, U. 1987. Changes in size of the stretch reflex of cat and man attributed to after-effects in muscle spindles. *Journal of Neurophysiology* 58:628-640.

Gregory, J.E., Wise, A. K., Wood, S. A., Prochazka, A. & Proske, U. 1998. Muscle history, fusimotor activity and the human stretch reflex. *Journal of Physiology* 513.3:927-934.

- Hasan, Z. & Houk, J.C. 1975. Transition in sensitivity of spindle receptors that occurs muscle is stretched more than a fraction of a millimetre. *Journal of Neurophysiology* 38, 673 – 689.
- Hammond, P.H. 1954. Involuntary activity in the biceps following the sudden application of velocity to the abducted forearm. *Journal of Physiology* 132, 14
- Henneman, E., Somjen, G. & Carpenter, D. 1965a. Functional significance of cell size in spinal motoneurons. *Journal of Neurophysiology* 28, 560 – 580.
- Henneman, E., Somjen, G. & Carpenter, D. 1965b. Excitability and inhibitability of motoneurons of different sizes. *J. Neurophysiology* 28, 599 – 620.
- Hill, A.V. 1938. The heat of shortening and the dynamic constants of muscle. *Proceedings of the Royal Society B* 126, 136 – 195 by Edman, K. A. P. 1992.
- Hoffer, J.A. & Andreassen, S. 1981a. Regulation of soleus muscle stiffness in pre-mammillary cats: intrinsic and reflex components. *Journal of Neurophysiology* 45, 267 – 285.
- Hoffer, J.A. & Andreassen, S. 1981b. Limitations in the servo-regulation of soleus muscle stiffness in pre-mammillary cats. In: *Muscle receptors and movement*, edited by Taylor & A. Prochaska. London: Macmillan 311 – 325.
- Hoffmann, P. 1918. Über die beziehungen der sehnenreflexe zur willkürlichen bewegung und zum tonus. *Zeitschrift für Biologie* 68, 351 – 370.
- Houk, J.C. 1979. In Houk, J.C. & Rymer, W.Z. 1981. In V.B. Brooks (Ed.) *Handbook of physiology: Sec 1. The nervous system; Vol 2. Motor control; 257 – 323*, Bethesda
- Houk, J.C. & Rymer, W.Z. 1981. In V.B. Brooks (Ed.) *Handbook of physiology: Sec 1. The nervous system; Vol 2. Motor control; 257 – 323*, Bethesda
- Houk, J.C., Singer, J.J. & Henneman, E. 1971. Adequate stimulus for tendon organs with observations on the mechanics of the ankle joint. *J. Neurophysiology* 34, 1051 – 1065.
- Komi, P.V. 1973. Relationship between muscle tension, EMG and velocity of contraction under concentric and eccentric work. *New Developments in EMG and Clinical Neurophysiology* (Ed.) Desmedt, J.E. Karger, Basel. 1, 596 – 606.
- Komi, P.V., Hyvärinen, T., Gollhofer, A. & Mero, A. 1986. Man-shoe-surface interaction: special problems during marathon running. *Acta Universitatis Ouluensis A179*, 69 – 72.

Kuruoglu, R. & Oh, S.J. 1993. Quantitation of tendon reflexes in normal volunteers. *Electromyography and Clinical Neurophysiology*. 33, 347 – 51.

Kyröläinen, H. & Komi, P.V. 1994. Neuromuscular performance of lower limbs during voluntary and reflex activity in power- and endurance-trained athletes. *European Journal of Applied Physiology & Occupational Physiology*. 69, 233 – 9.

Lee, R.G. & Tatton, W.G. 1978. Long loop reflexes in man: clinical applications. In: Desmedt JE, editor. *Cerebral motor control in man: long loop mechanisms*. Basel: Krager, 320 – 333.

Liddell, E.G. & Sherrington, C.S. 1924. Reflexes in response to stretch (myotatic reflexes). *Proc R. Soc. London Ser. B* 96, 212–242.

Matre, D.A., Sinkjaer, T., Svensson, P. & Arendt-Nielsen, L. 1998. Experimental muscle pain increases the human stretch reflex. *Pain*. 75, 331 – 9.

Matthews, P.B. 1981. Evolving views on the internal operation and functional role of the muscle spindle. *Journal of Physiology*. 320:1-30.

Matthews P.B. 1986. Observations on the automatic compensation of reflex gain on varying the pre-existing level of motor discharge in man. *Journal of Physiology (Lond)*. 374:73-90.

Matthews, P.B. 1991. The human stretch reflex and the motor cortex. *Trends in Neurosciences* 14, 87 – 91.

McMahon, T.A. 1984. *Muscles, reflexes and locomotion*. Princeton University Press, NJ.

Morgan, D.L. 1990. New insights into the behavior of muscle during active lengthening. *Biophysical Journal*. 57, 209 – 221.

Moritani, T., Muramatsu, S. & Muro, M. 1988. Activity of motor units during concentric and eccentric contractions. *American Journal of Physical Medicine*. 66, 338 – 350.

Nakazawa, K., Yamamoto, S.I. & Yano, H. 1997a. Short- and long-latency reflex responses during different motor tasks in elbow flexor muscles. *Experimental Brain Research*. 116, 20 – 8.

Nakazawa, K., Yano, H., Suzuki, Y., Gunji, A. & Fukunaga, T. 1997b. Effects of long term bed rest on stretch reflex responses of elbow flexor muscles. *Journal of Gravitational Physiology* 4, S37 – 40.

Nakazawa, K., Yano, H., Satoh, H. & Fujisaki, I. 1998. Differences in stretch reflex responses of elbow flexor muscles during shortening, lengthening and

isometric contractions. *European Journal of Applied Physiology and Occupational Physiology*. 77, 395 – 400.

Nakazawa, K., Yamamoto, S.I. Ohtsuki, T. Yano, H. & Fukunaga, T. 2001. Neural control: novel evaluation of stretch reflex sensitivity. *Acta Physiologica Scandinavica*. 172, 257 – 68.

Nardone, A. & Schieppati, M. 1988. Shift of activity from slow to fast muscle during voluntary lengthening contractions of the triceps surae muscles in humans. *Journal of Physiology*. 395, 363 – 81.

Nardone, A., Romano, C. & Schieppati M. 1989. Selective recruitment of high-threshold human motor units during voluntary isotonic lengthening of active muscles. *Journal of Physiology*. 409, 451 – 471.

Nardone, A., Corra, T. & Schieppati, M. 1990. Different activations of the soleus and gastrocnemii muscles in response to various types of stance perturbation in man. *Experimental Brain Research* 80, 323 – 332.

Nichols, T.R. & Houk, J.C. 1976. Improvement in linearity and regulation of stiffness that results from actions of stretch reflex.. *Journal of Neurophysiology*. 39, 119 – 42.

Nichols, T.R., Cope, T.C. & Abelew, T.A. 1999. Rapid spinal mechanisms of motor coordination. *Exercise and Sport Sciences Reviews*. 27, 255 – 84.

Nicol, C., Komi, P.V., Horita, T., Kyröläinen, H. & Takala, T.E. 1996. Reduced stretch-reflex sensitivity after exhausting stretch-shortening cycle exercise. *European Journal of Applied Physiology*. 72, 401 – 9.

Ogiso, K., McBride, J., Finni, T. & Komi, P. 2002a. Short-latency stretch reflex modulation in response to varying soleus muscle activities. *Journal of Electromyography and Kinesiology* 12, 17 – 26.

Ogiso, K., McBride, J., Finni, T. & Komi, P. 2002b. Stretch reflex mechanical response to varying types of precocious muscle activities. *Journal of Electromyography and Kinesiology* 12, 27 – 36.

Proske, U., Morgan, D.L. & Gregory, J.E. 1993. Thixotropy in skeletal muscle and in muscle spindles: a review. *Progress in Neurobiology*. 41, 705 – 21.

Romano, C. & Schieppati, M. 1987. Reflex excitability of human soleus motoneurons during voluntary shortening or lengthening contractions. *Journal of Physiology (Lond)* 390, 271 – 284.

SENIAM 8: European recommendations for surface electromyography. 1999. Eds. Hermens, H., Freriks, B., Merletti, R., Stegeman, D., Blok, J., Rau, G., Disselhorst-Klug C. & Hägg, G. ISBN 90-75452-15-2

Sinkjaer, T. 1997. Muscle, reflex and central components in the control of the ankle joint in healthy and spastic man. *Acta Neurologica Scandinavica. Supplementum.* 170, 1 – 28.

Sinkjaer, T. & Andersen, J.B. 1996. Larsen B. Soleus stretch reflex modulation during gait in humans. *Journal of Neurophysiology.* 76, 1112 – 20.

Sinkjaer, T., Toft, E., Andreassen, S. & Hornemann, B.C. 1988. Muscle stiffness in human ankle dorsiflexors: intrinsic and reflex components. *Journal of Neurophysiology* 60, 1110 – 1121.

Smeets, J.B., Erkelens, C.J. & van der Gon, J.J. 1995. Perturbations of fast goal-directed arm movements: different behavior of early and late EMG responses. *Source Journal of motor behavior* 27, 77 – 88.

Stein, R.B. & Capaday, C. 1988 The modulation of human reflexes during functional motor tasks. *Trends in Neurosciences.* 11, 328 – 32.

Stein, R. & Kearney, R. 1995. Nonlinear behavior of muscle reflexes at the human ankle joint. *Journal of Neurophysiology* 73, 65 – 72.

Tatton, W.G., Forner, S.D., Gerstein, G.L., Chambers, W.W. & Liu, C.N. 1975. The effect of postcentral cortical lesions on motor responses to sudden upper limb displacements in monkeys. *Brain Research.* 96, 108 – 13.

Toft, E., Sinkjaer, T. & Andreassen, S. 1989. Mechanical and electromyographic responses to stretch of the human anterior tibial muscle at different levels of contraction. *Experimental Brain Research* 74, 213 – 219.

Toft, E., Sinkjaer, T., Andreassen, S. & Larsen, K. 1991. Mechanical and electromyographic responses to stretch of the human ankle extensors. *Journal of Neurophysiology* 65, 1402 – 1410.

Voigt, M., Dyhre-Poulsen, P. & Simonsen, E.B. 1998. Modulation of short latency stretch reflexes during human hopping. *Acta Physiologica Scandinavica.* 163, 181 – 94.

Voss, H. 1971. *Anat. Anz.* 129, 562 – 572

Zehr, E.P & Stein, R.B. 1999. What functions do reflexes serve during human locomotion? *Progress in neurobiology* 58, 185 – 205.

Yang J. F, Stein R. B, & James K. B. 1991. Contribution of peripheral afferents to the activation of soleus muscle during walking in humans. *Experimental Brain Research* 87, 679 – 687.