

Investigating the origin of parthenogenesis and ploidy level in *Dahlica fennicella* (Lepidoptera: Psychidae)

Veronica Chevasco^{1,*}, Jelmer A. Elzinga¹, Juan A. Galarza²,
Johanna Mappes² & Alessandro Grapputo³

¹⁾ Department of Biological and Environmental Science, P.O. Box 35, FI-40014 University of Jyväskylä, Finland (*corresponding author's e-mail: vchevasco@gmail.com)

²⁾ Centre of Excellence in Biological Interactions, P.O. Box 35, FI-40014 University of Jyväskylä, Finland

³⁾ Department of Biology, University of Padova, Via Ugo Bassi 58/B, I-35121 Padova, Italy

Received 15 July 2012, final version received 14 Dec. 2012, accepted 5 Dec. 2012

Chevasco, V., Elzinga, J. A., Galarza, J. A., Mappes, J. & Grapputo, A. 2013: Investigating the origin of parthenogenesis and ploidy level in *Dahlica fennicella* (Lepidoptera: Psychidae). — *Ann. Zool. Fennici* 50: 125–145.

The theories for the predominance of sexual reproduction predict that parthenogens should have no long-term evolutionary potential due to the lack of genetic recombination, despite short term advantages. Although parthenogenesis is rare among high order animals, true parthenogens can be found in various taxa. The intriguing question of the proliferation and persistence of parthenogenetic species needs investigation. An ideal species for such research is a parthenogenetic moth *Dahlica fennicella* that appears to be as equally successful as other coexisting sexual species. We investigated whether high ploidy level of *D. fennicella* is due to hybridization between closely related sexual species. The results from flow cytometry measurements confirmed that *D. fennicella* is exclusively tetraploid whereas all sexual species of the genera *Dahlica* and *Siederia* are diploid. Our phylogenetic results showed the non-hybrid origin of the parthenogenetic *D. fennicella* in this group of Lepidoptera. Most likely, the parthenogenetic *D. fennicella* originated by autopolyploidization of *D. lazuri*, which is one of its closely related sexual species. We suggest that the apparent evolutionary success of *D. fennicella* might be due to polyploidy that could mask deleterious mutations and provide greater levels of genetic variation.

Introduction

Sexual reproduction is usually regarded as the primary mechanism underlying an organism's ability to adapt and evolve. Sex purportedly carries many advantages, such as genetic variability through recombination and helps to eliminate deleterious mutations (Muller 1964, Birky

1999, Rice & Friberg 2009). Despite its benefits, sexual reproduction carries costs that include the effort to find a suitable mate, exposure to predators during mating, disease transmission and the production of males (Crow 1999). Considering the advantages of sexual reproduction, the absence of sex in parthenogenetic species makes them appear to be evolutionary dead-ends (White

1973, Bell 1982). Nonetheless, parthenogenetic reproduction could be regarded as beneficial because there are no apparent costs, and females transmit their entire genome (Fournier & Aron 2009). Moreover, a wide variety of cytological mechanisms are involved in parthenogenetic reproduction. For instance, automictic parthenogenesis promotes genetic variation by retaining meiosis (e.g. stick insects *Bacillus withei* and *B. lynceorum*) (Scali 2009). Alternative reproducing mechanisms might be an underlying reason for the apparent success of some parthenogenetic species that proliferate nowadays, such as bdelloid rotifers (Mark Welch & Meselson 1998), aphids (Blackman *et al.* 2000), and stick insects (Schwander & Crespi 2009).

In insects, parthenogenetic lineages can originate by several mechanisms, such as mutations in genes that regulate sexual reproduction (Simon *et al.* 2003), or transmission of asexual genes (e.g. by parthenogenetically produced males in *Daphnia pulex*) (Innes & Hebert 1988). Bacterial infections by *Wolbachia* (Weeks *et al.* 2001) and *Cardinium* (Provencher *et al.* 2005) can also induce parthenogenesis. However, the most common route to parthenogenesis is by hybridization, which often leads to allopolyploidy (Foighil & Smith 1995, Delmotte *et al.* 2003, Johnson 2006, Shinohara *et al.* 2010).

Polyploidy and parthenogenetic reproduction are usually correlated (Suomalainen *et al.* 1987, Asker & Jerling 1992). A polyploid state can also be generated by autopolyploidization as a consequence of mitotic or meiotic failure of cell division (Otto & Whitton 2000). High ploidy levels can be beneficial, especially for parthenogenetic species because polyploidy can allow genetic variation. Polyploids can be more vigorous than their diploid parents (heterosis) and can mask the deleterious effects of mutations due to gene redundancy. Some other advantages of polyploidy include adaptations to extreme habitats and new environments (Seiler 1961, Stenberg & Lundmark 2004, Schurko *et al.* 2009) and a way to promote evolutionary novelty (Otto & Whitton 2000, Mable 2004). However, polyploidy includes some disadvantages such as disrupting effects of cell and nuclear enlargement, production of aneuploid cells and epigenetic instability (Comai 2005).

Despite the apparent link between parthenogenesis and polyploidy, few systems are suitable to examine different hypotheses about the role of polyploidy in the absence of sex. We focus on Finnish bagworm moths from the tribe Dahlicini (Lepidoptera: Psychidae), which occur in forest habitats. The tribe Dahlicini includes the genera *Dahlica* and *Siederia* (Bengtsson *et al.* 2008). According to Sobczyk (2011) the genus *Dahlica* comprises 46 described species with a Palearctic distribution. On the other hand, the genus *Siederia* is distributed in Palearctic and Nearctic with 17 described species. In Finland, the genus *Dahlica* is represented by *D. charlottae*, *D. fennicella*, *D. lazuri*, *D. lichenella* and *D. triquetrella*. In contrast, the genus *Siederia* includes *S. listerella*, *S. rupicolella* and *S. cembrella*. Bagworm moths are an interesting system to study alternative reproductive strategies because parthenogenetic moths appear to be as successful as coexisting sexual species.

In our study, we evaluated possible processes that might have contributed to the origin of parthenogenesis within the Naryciinae in central Finland. We included five sexual species (*Dahlica charlottae*, *D. lazuri*, *D. lichenella*, *Siederia listerella* and *S. rupicolella*), and two parthenogenetic species (*D. fennicella* and *D. triquetrella*) all occurring in central Finland.

Here, we focus on the origin of parthenogenesis and the implications of high ploidy levels in *D. fennicella*, a parthenogenetic bagworm moth. Recent evidence shows unexpected signs of genetic variability occurring in some of the parthenogenetic species of moths (Chevasco *et al.* 2012). Previous studies suggested that parthenogenesis evolved several times: for example, it was suggested that parthenogenetic species evolved independently from different sexual ancestors (Grapputo *et al.* 2005), although this evidence was not conclusive as it was based only on mitochondrial DNA. The processes and causes that generate and maintain parthenogenetic reproduction in bagworm moths currently remain unclear. Conclusive evidence about a hybrid or autopolyploid origin of parthenogenesis is still lacking for the group due to limited knowledge about ploidy levels and genome sizes in both parthenogenetic and sexual species. Specifically, we ask whether parthenogenetic

reproduction has originated by (i) hybridization events between two sexual species, or (ii) through whole genome duplication (autopolyploidization) of a related sexual species. To find the answer, we employ an approach consisting of the analysis of ploidy levels and genome sizes of parthenogenetic and sexual species and phylogenetic reconstruction using mitochondrial and nuclear genes.

Material and methods

Bagworm moth species and sampling

Bagworm moths (Lepidoptera: Psychidae) comprise a taxonomically diverse group with a worldwide distribution (Rhainds *et al.* 2009). In Finland, the species of the subfamily Naryciinae occur in forest habitats where both sexual and parthenogenetic species coexist (Kumpulainen *et al.* 2004, Elzinga *et al.* 2011). Their common name makes reference to the fact that the larvae live and complete their development in a self-enclosing case made of forest debris (Rhainds *et al.* 2009).

Last instar larvae were collected in early March of the years 2007 to 2011 by setting tape traps around tree trunks in areas around the city of Jyväskylä (for details refer to Elzinga *et al.* 2011). We also included some *D. fennicella* individuals from Estonia to compare them with the Finnish specimens. Larvae were kept in individual containers simulating field conditions (10–20 °C with 85% humidity) until adults hatched.

We initially divided emerged adults based on reproductive strategy. Adults were kept at 4 °C for a maximum of two–three days prior to flow-cytometry analysis.

Flow cytometry

Flow cytometry measurements were conducted in order to determine ploidy levels and genome sizes of parthenogenetic and sexual bagworm moths. Only young living specimens were suitable for this technique. Each individual was cut in half, so that the head and a part of the thorax could be immediately processed for flow cytometry. Preliminary measurements conducted in 2008 showed that the head and a part of the thorax gave clearer flow-cytometry results than other tissue. The remaining body along with individuals not used in the flow-cytometry measurements were preserved in 99% ethanol at 4 °C until DNA was extracted.

The individuals collected in 2008 were analyzed at the Swiss Federal Institute of Aquatic Science and Technology (EAWAG). Specimens collected in 2009, 2010 and 2011 were tested at the University of Jyväskylä, in Finland. We included five sexual and two parthenogenetic species (Table 1). Sample size variation was due to the difficulty of accurate species identification based on morphology, as the only way to discriminate the species is based on DNA barcoding (V. Chevasco unpubl. data). Consequently, specimens had to be analyzed prior to knowing their species — i.e. before the DNA analyses — because we needed fresh tissue.

Table 1. Genome size (*C* values; mean ± SE) for different species of bagworm moths. The values of “relative DNA” were obtained without taking into account the value of the genome size of *D. melanogaster*.

Species	<i>n</i>	Relative DNA*	Genome size (pg)	Genome size (Mb)
Sexual				
<i>D. charlottae</i>	151	1.77 ± 0.01 ^a	0.32 ± 0.001	309.51 ± 1.23
<i>D. lichenella</i>	62	2.21 ± 0.01 ^b	0.40 ± 0.002	386.29 ± 2.26
<i>S. listerella</i>	31	2.10 ± 0.01 ^c	0.38 ± 0.002	366.55 ± 2.62
<i>S. rupicolella</i>	45	1.87 ± 0.01 ^d	0.34 ± 0.002	326.54 ± 1.69
<i>D. lazuri</i>	43	2.10 ± 0.02 ^c	0.38 ± 0.003	366.81 ± 3.81
Parthenogenetic				
<i>D. fennicella</i>	60	4.03 ± 0.03 ^e	0.73 ± 0.005	706.12 ± 4.53
<i>D. triquetrella</i>	12	4.00 ± 0.06 ^e	0.72 ± 0.01	701.13 ± 10.85

* values marked with the same letters do not differ statistically (Dunnnett’s post-hoc test or an independent *t*-test).

Tissues were stained with the CyStain PI absolute T kit from Partec (Muenster, Germany) according to the manufacturer's instructions. We used heads of *Drosophila melanogaster* (Oregon-R strain) females as the size standard of known genome size. We first placed the head and a part of the abdomen of each moth in 200 μ l of CyStain extraction buffer. Next, we added a head of *D. melanogaster* and ground the tissues with a tissue grinder. This solution was incubated at room temperature for 10 minutes. In Jyväskylä, the standard of known genome size was prepared separately: the head of a *D. melanogaster* female was placed in 200 μ l of CyStain extraction buffer, and the tissue was homogenized with a tissue grinder. We then added 40 μ l of the *D. melanogaster* solution to each moth sample. The samples were incubated at room temperature for 10 minutes. In order to reduce clumps in the solution, we placed each individual sample in a sonicator (ultrasonic cleaner Branson 200) for 2 minutes.

In both Finland and Switzerland, the resulting solution was filtered through 30 μ m Partec CellTrics filters. At EAWAG, we added 800 μ l of CyStain staining buffer that contained RNase. Samples were incubated in the dark for at least 40 minutes prior to each measurement. We used the FL3 channel to assess PI fluorescence (DNA content) in a Partec Ploidy Analyzer PA-II. For all the runs, the machine was calibrated using a few μ l of the solution that contained a head of *D. melanogaster*, prepared in the same way as the moth samples. The gain of the FL3 laser was adjusted so that the *D. melanogaster* peak was always located at a 150 units. Each sample was run until it reached a count of 10 000 events. In Jyväskylä, we added 400 μ l of CyStain staining buffer with RNase to each sample. Subsequently, each sample was incubated in the dark for 40–60 minutes before each measurement. We used the FL2-H channel to assess PI fluorescence (DNA content) in a FACSCalibur Flow Cytometer. We adjusted the gain so that the standard peak was always centered at 100 FL2-H units. Each sample was run until it reached a count of 30 000 events.

Data analysis

The output files from the flow cytometry meas-

urements (FCS files) were exported as text using WinMDI ver. 2.9 (Joseph Trotter, The Scripps Institute, La Jolla, CA) and pasted to an MSEXcel (ver. 14) sheet. We then calculated the mean fluorescence from the standard (*D. melanogaster*) and the moth-sample 2C (diploid) or 4C (tetraploid) peak (in FL3 units for 2008 and FL2H units for 2009, 2010 and 2011). In order to combine the two sets of the data, we increased the number of channels in the spreadsheet for the samples that were analyzed at the EAWAG. The sample (moth) and standard *D. melanogaster* peaks were confined by establishing their range, cutoff range and cutoff point. The mean of the peaks of interest was calculated by avoiding cell clumps and debris.

The DNA content for each moth species was calculated according to Tsutsui *et al.* (2008) as the ratio between the mean fluorescence 2C or 4C peak of the moth and the overall average (97.21 units) mean fluorescence 2C peak of *D. melanogaster*. We call this ratio a “relative DNA” because we did not multiply the result by the value of the genome size of *D. melanogaster*, as there is some variation in its estimation (Bennett *et al.* 2003, Gregory & Johnston 2008). Next, we used the “relative DNA” ratio in ANOVA and Dunnett's post-hoc test to determine possible differences in the genome sizes between the sexual species, and in an independent *t*-test to assess possible differences between parthenogenetic species (Table 1). Finally, to express the genome size in Mb and pg we multiplied the “relative DNA” by the estimated genome size of *D. melanogaster* (175 Mb and 0.18 pg) (Bennett *et al.* 2003). All the statistical analyses were conducted in PASW Statistics ver. 18.00.

Amplification of mitochondrial and nuclear genes

DNA was extracted from sexual and parthenogenetic individuals using the QIAGEN DNeasy Blood & Tissue kit (QIAGEN, Hilden, Germany) according to the manufacturer's protocol and by eluting DNA in 100 μ l of buffer AE. Fragments of four genes were amplified and sequenced: both subunits of the mitochondrial cytochrome

oxidase (*COI* and *COII*), the nuclear carbamoyl-phosphate synthetase 2 (*CAD*), and the malate dehydrogenase gene (*MHD*) (GenBank accession numbers *COI*: JX307864-JX307990; *COII*: JX308108-JX308217; *CAD*: JX308044-JX308107; *MDH*: JX307991-JX308043). We used four primer pairs (Table 2).

All PCR reactions were performed using the FailSafe PCR System (Epicentre Biotechnologies, Madison, Wisconsin) in a total reaction volume of 20 μ l, which included 20–50 ng of DNA, 0.5 μ M each of forward and reverse primer, 10 μ l of Buffer B 2X and 2.5 U μ l⁻¹ of Taq DNA polymerase. The reaction conditions were as follows: an initial denaturation step of 30 s at 95 °C, 30 cycles consisting of 30 s at 95 °C, 30 s at 49–50 °C annealing temperature (depending on the primer combinations, see Table 2, Ta) and 1.5 min at 72 °C followed by one cycle of 5 min at 72 °C. The PCR products were verified by electrophoresis in a 1% agarose gel. If there was a single band, the products were purified using Exonuclease I–Shrimp Alkaline Phosphatase (Amersham Biosciences). If more bands were visualized, the expected product was cut from the gel and purified with the QIAquick gel extraction kit from QIAGEN according to the manufacturer's instructions. All the sequencing reactions were conducted with the BigDye® Terminator ver. 3.1, Cycle Sequencing Kit (Applied Biosystems) using M13 primers (0.2 μ M) and run on an ABI 3130xl Genetic Analyzer (Applied Biosystems). The PCR products were sequenced on both strands, the sequences were edited for ambiguities in Seqscape ver. 2.6 (Applied Bio-

systems). Subsequently, the sequences were aligned with ClustalW in MEGA ver. 5 (Tamura *et al.* 2011) using the default settings.

We identified the individuals to species based on a DNA barcoding approach by amplifying the cytochrome oxidase subunit II gene (*COII*). For details see the Appendix (Fig. A5).

Genetic distance

We calculated the pairwise sequence divergence among the haplotypes based on the K2P model. Intraspecific and interspecific genetic distances were obtained for each of the mitochondrial and nuclear gene fragments.

Phylogenetic reconstruction

This analysis was conducted to determine the origin and phylogenetic relationships of the parthenogenetic moth *D. fennicella*. We also included another parthenogenetic species, *D. triquetrella*.

The best-fit models for nucleotide substitution were obtained with jModelTest ver. 2.1.1 (Darriba *et al.* 2012) using Akaike's information criterion (AIC) (Posada & Crandall 1998). For the mitochondrial genes, we obtained the general time reversible model (GTR; Lanave *et al.* 1984) with a proportion of invariable sites for *COI* (GTR + I). For *COII*, we used the Kishino and Yano model (HKY; Hasegawa *et al.* 1985) with gamma-distributed rate variation and a propor-

Table 2. Primer pairs details for the amplification of mitochondrial and nuclear DNA. All primer pairs had an M13 "tail" either forward 5'-TTGTAACGACGGCCAGT-3' or reverse 5'-CAGGAAACAGCTATGACC-3'.

Gene	Primer	Size (bp)	Annealing temp. (°C)	Sequence	Source
<i>COI</i>	LCO(fwd)	657	50	G GTC AAC AAA TCA TAA AGA TAT TGG	Wahlberg & Wheat 2008
	HCO(rev)			T AAA CTT CAG GGT GAC CAA AAA ATC A	
<i>COII</i>	COII-M1F(fwd)	331	50	TT GGA TTT AAA CCC CAT YTA*	Simon <i>et al.</i> 1994
	C2-N-3389(rev)			TCA TAA GTT CAR TAT CAT TG	
<i>CAD</i>	psyCADF(fwd)	604	49	TGG TAA AAA TTC CAA GAT GG	N. Wahlberg pers. comm.
	psyCADR(rev)			ATC AAA TTC GAC AGA ACT GC	
<i>MDH</i>	MDHF(fwd)	730	50	G AYA TNG CNC CNA TGA TGG GNG T	Wahlberg & Wheat 2008
	MDHr(rev)			AGN CCY TCN ACD ATY TTC CAY TT	

* Naryciinae-specific forward primer.

tion of invariable sites (HKY + I + Γ). The most suitable model for the *CAD* gene was the general time reversible model (Lanave et al. 1984) with a proportion of invariable sites (GTR + I). The best model for *MDH* was the symmetrical model (SYM; Zharkikh 1994) with a proportion of invariable sites and gamma-distributed rate variation across sites (SYM + I + Γ). The sequences of *Diplodoma laichartingella* (Mutanen et al. 2010) (GenBank accession numbers *COI*: GU828726 *CAD*: GU828212 and *MDH*: GU830429) and *Narycia duplicella* were included as outgroups. We did not obtain a PCR amplification product for *MDH* in *N. duplicella* and the *COII* fragment was not available for *D. laichartingella*. Therefore, these sequences were coded as missing data.

Bayesian phylogenetic trees were obtained with MrBayes ver. 3.2 (Ronquist et al. 2012). Separate trees were obtained for *CAD* and *MDH*. Concatenated gene trees included mitochondrial gene fragments (*COI-COII*) and four gene sections (*COI-COII-CAD-MDH*). Concatenated phylogenetic trees were analyzed with unlinked models. Two simultaneous independent runs with three heated chains and one “cold” chain were run for 1–5 million generations with a sample frequency of 1000 and a burnin of 25% of the total number of samples. We always used the contype = allcompat option. The default of a random starting tree was used at all times. The standard deviation of split frequencies (≤ 0.01) and the potential scale reduction factor (near 1.00) were used as the parameters for convergence (Hall 2011). The support of each cluster was evaluated following the criteria of Hillis and Bull (1993) where a Bayesian posterior probability (BI) of ≥ 0.95 is considered to significantly support taxonomic relationships. For the nuclear genes, the heterozygous sites were left with the nucleotide ambiguity code (unphased). Ambiguous characters are treated as uncertain in MrBayes as they do not carry any phylogenetic information. Phylogenetic relationships were also reconstructed using Maximum Likelihood. Separate and concatenated gene trees were estimated with PhyML (Guindon et al. 2009) (for details see the Appendix). All the phylogenetic trees were edited using MEGA ver. 5 (Tamura et al. 2011).

Concatenated gene trees were built in an attempt to get a more robust phylogenetic infer-

ence. However, this approach might violate the different evolutionary histories for each gene (Satler et al. 2011).

Results

Flow cytometry

Our ploidy determination showed that all sexual species (*D. charlottae*, *D. lazuri*, *D. lichenella*, *S. listerella* and *S. rupicolella*) were diploid, whereas the parthenogenetic species *D. fennicella* and *D. triquetrella* were tetraploids. The ploidy levels of bagworm moths showed different patterns (Fig. 1).

We determined the parthenogenetic species to be tetraploid because they had approximately twice the amount of DNA as compared with the sexual species. For instance, *D. lazuri* had a mean genome size value of 0.38 pg, while the parthenogenetic *D. fennicella* had a mean value of 0.73 pg.

Genome size for sexual species differed among *D. charlottae*, *D. lazuri*, *D. lichenella*, *Sideria listerella* and *S. rupicolella* ($F_{4,327} = 297.95$, $p < 0.05$). The post-hoc Dunnett test indicated that the genome size of *D. charlottae* ($M = 1.77$, $SD = 0.09$) was significantly smaller than that of *D. lichenella* ($M = 2.21$, $SD = 0.01$) and that of *S. rupicolella* ($M = 1.87$, $SD = 0.06$). *Dahlia lichenella* had the largest genome of all sexual species (Table 1). The genome sizes of *S. listerella* ($M = 2.10$, $SD = 0.08$) and *D. lazuri* ($M = 2.1$, $SD = 0.14$) did not differ significantly. In addition, an independent samples *t*-test indicated that there was no significant difference in genome size between the two parthenogenetic species *D. fennicella* ($M = 4.03$, $SD = 0.20$) and *D. triquetrella* ($M = 4.00$, $SD = 0.21$) ($t_{70} = 0.45$, $p = 0.66$; Table 1).

Genetic distances

The intraspecific pairwise sequence divergence calculated for each of the mitochondrial and nuclear gene fragments was less than 1% (Table 3). Interestingly, the lowest interspecific distance was between the parthenogenetic *D. fennicella* and the sexual *D. lazuri*. Mitochon-

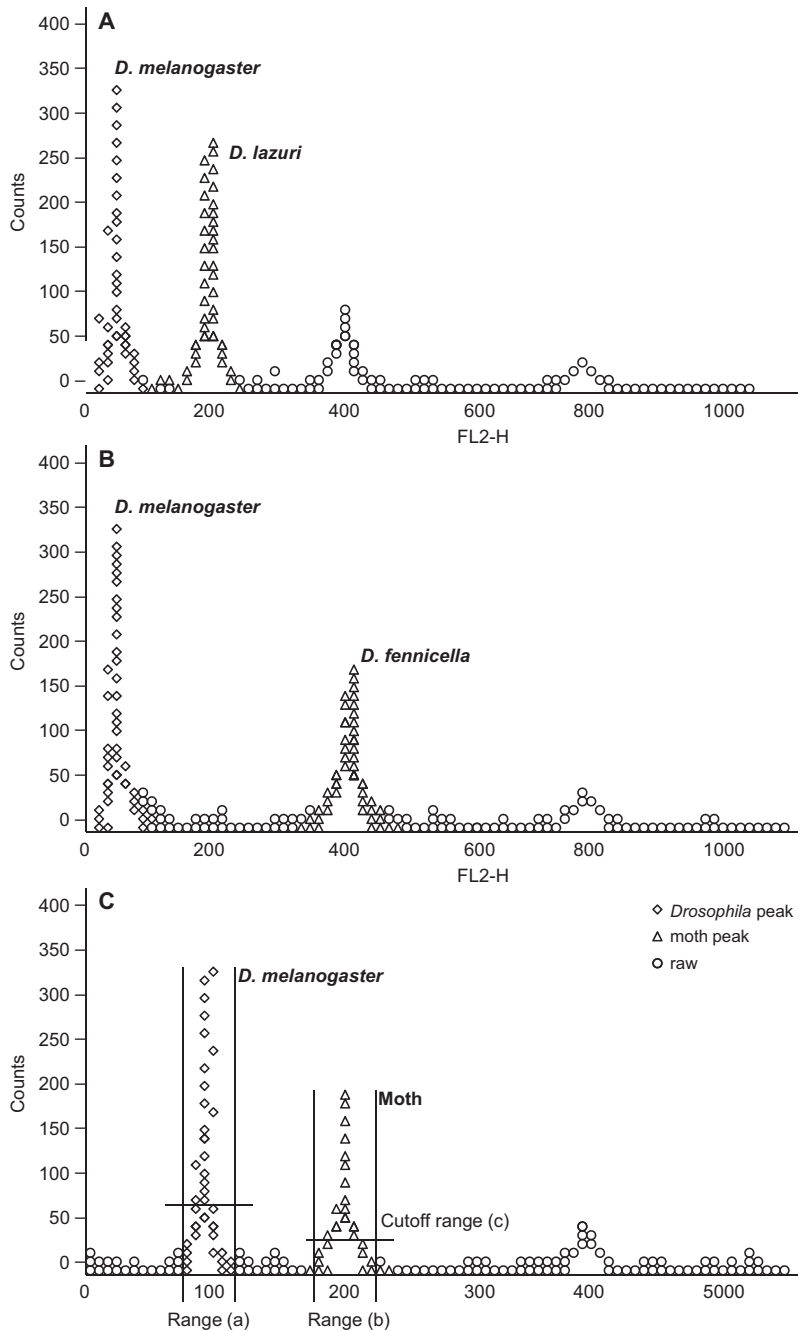

Fig. 1. Graphical representation of the ploidy levels in bagworm moths. In each graph the standard of known genome size *D. melanogaster* is shown next to the moth peak. **(A)** The diploid status (peak 2C) is represented by the sexual species *D. lazuri*. **(B)** The tetraploid status (peak 4C) of the parthenogenetic species is represented by *D. fennicella*; we also found the same status for *D. triquetrella*. **(C)** The way the means were calculated for each of the peaks; the peaks were confined by establishing their ranges (a, b) and cutoff range (c).

drial gene fragments showed a 0.9% divergence for *COI* and 1.5% for *COII*, whereas nuclear genes had no divergence for *CAD* and 1.6% for *MDH*. Among the species, the range of divergence for each of the mitochondrial genes was 2%–6.7%, whereas divergence for each of the nuclear genes was 1%–7%.

Phylogenetic analysis

We sequenced a fragment (657 bp) of the subunit I of the cytochrome oxidase gene (*COI*) and found 89 sites to be variable (13.55%), but only 78 (11.87%) were parsimony informative. On the partial sequence of the *COII* gene (331 bp),

42 sites were variable (12.69%) while 40 sites (12.1%) were parsimony informative. Additionally, we included the partial sequence (604 bp) of the carbamoyl-phosphate synthetase 2 (*CAD*) nuclear gene, in which 60 sites were variable (9.93%) and 51 (8.44%) sites were parsimony informative. Finally, the nuclear malate-dehydrogenase gene fragment (*MDH*) was 730 bp, of which 121 sites were variable (16.57%) and 111 (15.21%) sites were parsimony informative.

The different genes and methods of phylogenetic reconstruction assigned all the individuals to a species-specific group. The phylogenetic tree topologies were not fundamentally different according to the different genes and methods of phylogenetic reconstruction. Therefore, we describe the results from Bayesian Inference and included the Maximum Likelihood trees in the Appendix (see Figs. A1–A4).

Carbamoyl-phosphate synthetase 2 (*CAD*)

The parthenogenetic *D. triquetrella* occupied a basal position in reference to the not supported group comprising the genera *Dahlica* and *Siederia* (BI = 0.38, Fig. 2). The parthenogenetic *D. fennicella* and the sexual *D. lazuri* did not form

separate clusters (BI = 0.99). The weakly supported monophyletic group of *D. lichenella*, *D. fennicella* and *D. lazuri* (BI = 0.78) was recovered as the sister species of *D. charlottae* with no support (BI = 0.39).

Malate dehydrogenase gene (*MDH*)

We were unable to obtain a PCR product of the *MDH* gene for *N. duplicella*, therefore, we included a sequence of *D. laichartingella* as the outgroup (Fig. 3).

According to the phylogenetic reconstruction, *D. fennicella*, *D. lichenella* and *D. lazuri* formed a weakly supported monophyletic group (BI = 0.54). Within this cluster the parthenogenetic *D. fennicella* and the sexual *D. lazuri* were paraphyletic. The Finnish *D. fennicella* formed a separate cluster (BI = 0.96) from the Estonian *D. fennicella* (08-EST-2-L and 08-EST-5-L) (BI = 0.94) and both clustered with *D. lazuri* specimens (07-POT-5-M and 08-MM-18-F).

Concatenated mtDNA

The sister-species status of the sexual *D. lazuri*

Table 3. Intraspecific (Intra) and interspecific pairwise sequence divergence (K2P model, pairwise deletion) among the species of the genera *Dahlica* and *Siederia* for two mitochondrial (*COI*, *COII*) and two nuclear genes (*CAD* and *MDH*). Dchar = *D. charlottae*, Dfen = *D. fennicella*, Dlaz = *D. lazuri*, Dlich = *D. lichenella*, Slist = *S. listerella*, Srupi = *S. rupicolella*.

	<i>COI</i> 657 bp							<i>CAD</i> 604 bp						
	Intra	Dchar	Dfen	Dlaz	Dlich	Slist	Srupi	Intra	Dchar	Dfen	Dlaz	Dlich	Slist	Srupi
Dchar	0							0.001						
Dfen	0	0.041						0	0.029					
Dlaz	0	0.038	0.009					0	0.027	0				
Dich	0.006	0.048	0.031	0.031				0.002	0.029	0.013	0.012			
Slist	0.001	0.048	0.052	0.052	0.063			0	0.03	0.034	0.032	0.032		
Srupi	0.004	0.043	0.046	0.039	0.047	0.051		0.01	0.037	0.037	0.036	0.042	0.03	
Dtriq	0	0.044	0.056	0.053	0.057	0.062	0.056	0	0.032	0.035	0.033	0.03	0.032	0.042

	<i>COII</i> 331 bp							<i>MDH</i> 730 bp						
	Intra	Dchar	Dfen	Dlaz	Dlich	Slist	Srupi	Intra	Dchar	Dfen	Dlaz	Dlich	Slist	Srupi
Dchar	0.004							0.018						
Dfen	0.001	0.05						0.007	0.067					
Dlaz	0	0.051	0.015					0.016	0.06	0.016				
Dich	0.006	0.058	0.031	0.023				0.009	0.068	0.034	0.034			
Slist	0.005	0.06	0.065	0.062	0.067			0.003	0.077	0.077	0.069	0.077		
Srupi	0.001	0.052	0.047	0.047	0.054	0.052		0.005	0.052	0.049	0.045	0.049	0.057	
Dtriq	0	0.032	0.037	0.037	0.042	0.046	0.038	0.001	0.059	0.051	0.046	0.053	0.061	0.048

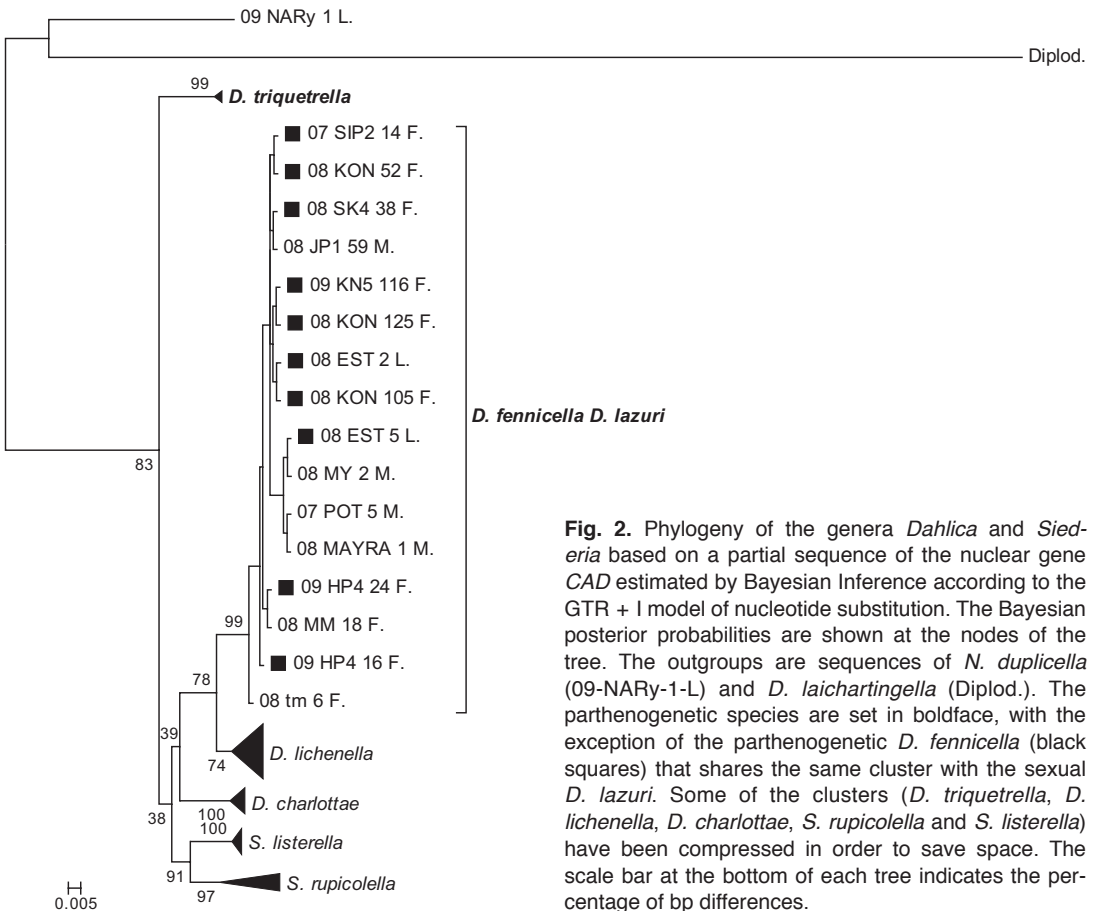

Fig. 2. Phylogeny of the genera *Dahlica* and *Siederia* based on a partial sequence of the nuclear gene *CAD* estimated by Bayesian Inference according to the GTR + I model of nucleotide substitution. The Bayesian posterior probabilities are shown at the nodes of the tree. The outgroups are sequences of *N. duplicella* (09-NARY-1-L) and *D. laichartingella* (Diplod.). The parthenogenetic species are set in boldface, with the exception of the parthenogenetic *D. fennicella* (black squares) that shares the same cluster with the sexual *D. lazuri*. Some of the clusters (*D. triquetrella*, *D. lichenella*, *D. charlottae*, *S. rupicolella* and *S. listerella*) have been compressed in order to save space. The scale bar at the bottom of each tree indicates the percentage of bp differences.

and parthenogenetic *D. fennicella* was well supported (BI = 1, Fig. 4). Additionally, we found strong support (BI = 1) for the monophyletic status of the cluster formed by *D. fennicella*, *D. lazuri* and *D. lichenella*. The other parthenogenetic species *D. triquetrella* was found to be the sister species of *D. charlottae* but with weak support (BI = 0.62).

Concatenated mtDNA and nDNA

The phylogenetic tree from the concatenated mitochondrial and nuclear sequences (Fig. 5) was similar to that obtained with *MDH* alone, showing the paraphyly of *D. fennicella*. The cluster formed by the parthenogenetic *D. fennicella* and sexual *D. lazuri* species was well supported (BI = 1), and was the sister group of *D. lichenella* (BI = 1). We found no support for

the sister-species status of *D. charlottae* (BI = 0.52) with the monophyletic group of *D. fennicella*, *D. lazuri* and *D. lichenella*. Parthenogenetic *D. triquetrella* was basal to the rest of the *Dahlica* species with no support (BI = 0.60). The sister-species status of *S. rupicolella* and *S. listerella* was weakly supported (BI = 0.82). The monophyly of *Dahlica* (BI = 0.60) and *Siederia* (BI = 0.82) was not well supported according to the concatenated sequences of the four gene fragments.

Discussion

Overall, we confirmed the correlation between parthenogenesis and high-ploidy levels in bagworm moths. Moreover, our results suggest that parthenogenetic *D. fennicella* might have originated from a closely related sexual form.

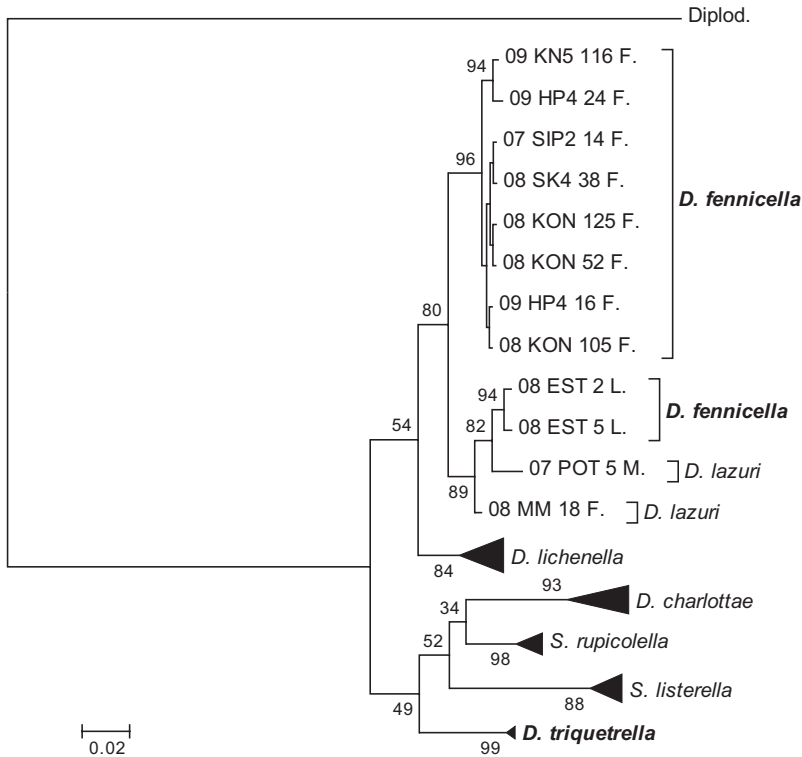

Fig. 3. Phylogeny of the genera *Dahlica* and *Siederia* based on a partial sequence of the nuclear *MDH* gene estimated by Bayesian Inference according to the SYM + I + Γ model of nucleotide substitution. The Bayesian posterior probabilities are shown at the nodes of the tree. The outgroup is a sequence of *D. laichartingella* (Diplod). The parthenogenetic species are set in boldface. Some of the clusters (*D. triquetrella*, *D. lichenella*, *D. charlottae*, *S. rupicolella* and *S. listerella*) have been compressed in order to save space. The scale bar at the bottom of each tree indicates the percentage of bp differences.

Ploidy level and genome size of Naryciinae

We verified that parthenogenetic *D. fennicella* and *D. triquetrella* are tetraploids, while all the sexual species are diploids. This result has important implications in the apparent success and evolution of parthenogenetic species. According to Hörandl (2009) polyploidy helps parthenogenetic species to violate the basic assumptions that higher mutational load or lower genotypic variation would be disadvantageous. Therefore, a polyploid organism has unique gene combinations due to a double set of chromosomes, high levels of heterozygosity and altered expression patterns (Parker & Niklasson 2000).

Our results also revealed that the genome sizes of the bagworm moths are in the range of those of other insects (0.2–1.9 pg) (Gregory 2002). Based on reported values using FCM, sexual bagworm moths have values close to those of *Heliconius erato petiverana* (0.41 pg) (Tobler et al. 2004), *Heliconius melpomene*

(0.30 pg) (Jiggins et al. 2005) and *Heliothis virescens* (0.41 pg) (Taylor et al. 1993). According to reported estimates of genome size based on Feulgen image analysis densitometry of spermatozoa (Gregory & Hebert 2003), sexual bagworm moths values are close to that of the monarch butterfly *Danaus plexippus* (0.29 pg). In contrast, the tetraploid parthenogenetic species *D. triquetrella* and *D. fennicella* have smaller genomes when compared with the geometrid moth *Euchlaena irraria* (1.9 pg). It has been suggested that Feulgen image analysis densitometry of spermatozoa overestimates genome size (Rees et al. 2007). However, this overestimation is likely not true, since the reported value for the sequenced genomes of *Danaus plexippus* (Zhan et al. 2011) and *Heliconius melpomene melpomene* (Dasmahapatra et al. 2012) is 0.28 pg.

In some cases, the genome size values were congruent with phylogenetically defined lineages, as it was reported in the polyploid plants of the genus *Orobancha* (Weiss-Schneeweiss et al. 2005). However in this study, the pattern of

Fig. 4. Phylogeny of the genera *Dahlica* and *Siederia* based on the concatenated partial mitochondrial sequences estimated by Bayesian Inference according to the following models of nucleotide substitution: GTR + I (*COI*) HKY + I + Γ (*COII*). The Bayesian posterior probabilities are shown at the nodes of the tree. The outgroups are sequences of *N. duplicella* (09-NARY-1-L) and *D. laichartingella* (Diplod.). The parthenogenetic species are set in boldface. Some of the clusters (*D. triquetrella*, *D. lichenella*, *D. charlottae*, *S. rupicolella* and *S. listerella*) have been compressed in order to save space. The scale bar at the bottom of each tree indicates the percentage of bp differences.

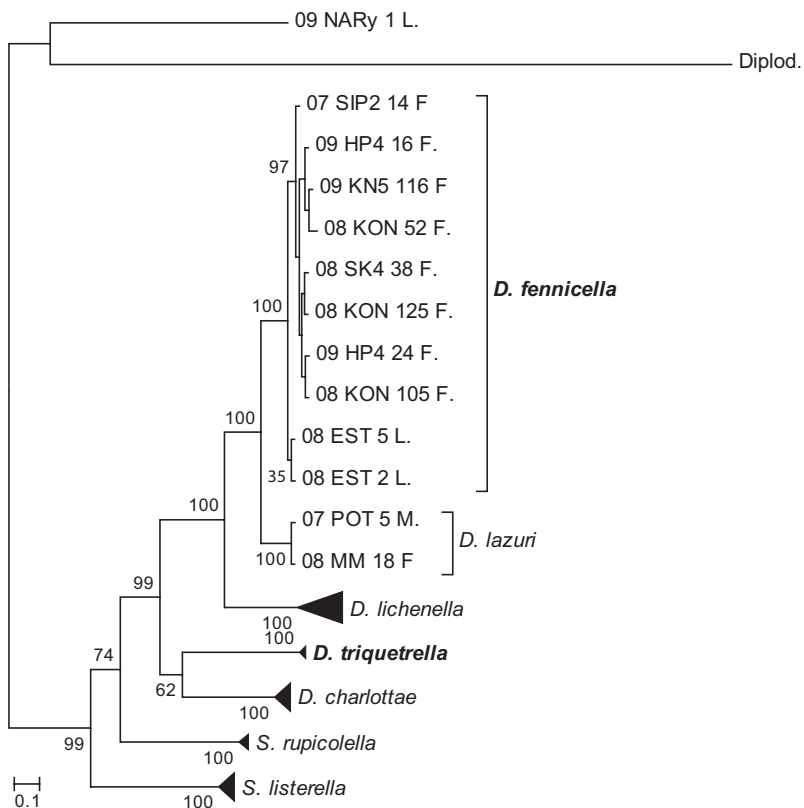

genome size in bagworm moths did not match the species-specific clusters. For instance, there were no significant differences in genome size for *D. triquetrella* and *D. fennicella*, although these two parthenogenetic species formed different clusters in the phylogenetic trees. Only the species of the genus *Orobanche* might have highly congruent genome sizes and phylogenetically defined lineages based on ITS sequences.

Origin of parthenogenesis in *D. fennicella*

Our results suggest one evolutionary transition for the origin of parthenogenesis in *D. fennicella*. When we examined the *CAD* gene, we found that parthenogenetic *D. fennicella* clustered in the same group with sexual *D. lazuri*. In the analysis of mitochondrial genes, we found a single *D. fennicella* cluster, which implies a single origin for parthenogenetic reproduction in this lineage. Conversely, analysis of *MDH* and the fully concatenated gene tree showed

two groups of *D. fennicella* (one from Finland and another from Estonia mixed with *D. lazuri*). One possible explanation for two distinct geographical groups in *D. fennicella* is based on the effects of incomplete lineage sorting of species with recent evolutionary history. In case of incomplete lineage sorting, different gene sequences or genomes will not always group the species in equivalent clusters due to different alleles. In theory, the ancestor of *D. fennicella* was diploid and had two different alleles for the *MDH* gene. Once the genome was duplicated, each one of the alleles was fixed in a specific population. As a result, each population (Finnish and Estonian) has a distinctive haplotype.

The second possible explanation is dissimilar evolutionary histories of the gene fragments used. We only report statistical reconstructions (Boussau & Daubin 2010) based on partial sequences of two mitochondrial and two nuclear genes. An alternative, but less likely scenario to clarify our results is two possible geographical transitions to parthenogenesis. However, the

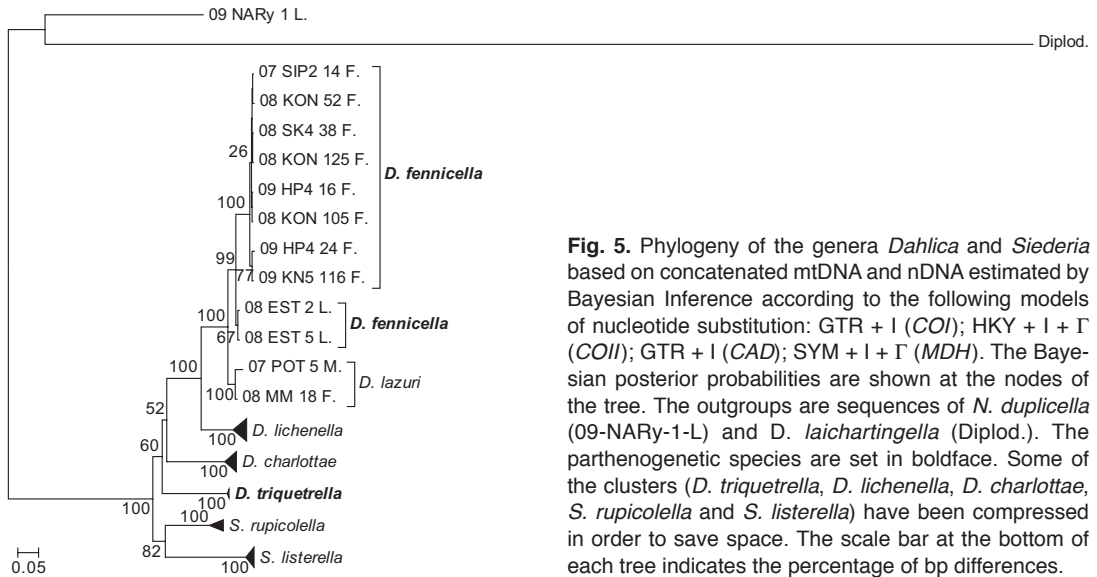

Fig. 5. Phylogeny of the genera *Dahlica* and *Siederia* based on concatenated mtDNA and nDNA estimated by Bayesian Inference according to the following models of nucleotide substitution: GTR + I (*COI*); HKY + I + Γ (*COII*); GTR + I (*CAD*); SYM + I + Γ (*MDH*). The Bayesian posterior probabilities are shown at the nodes of the tree. The outgroups are sequences of *N. duplicella* (09-NARy-1-L) and *D. laichartingella* (Diplod.). The parthenogenetic species are set in boldface. Some of the clusters (*D. triquetrella*, *D. lichenella*, *D. charlottae*, *S. rupicolella* and *S. listerella*) have been compressed in order to save space. The scale bar at the bottom of each tree indicates the percentage of bp differences.

only two Estonian samples were dead larvae, making it impossible to confirm their reproductive strategy as adults. Nonetheless, those individuals were classified as *D. fennicella* according to our DNA barcoding approach, and for that reason we speculate about a possible second transition to parthenogenetic reproduction.

In any case, we believe that conclusive evidence for the multiple geographical transitions to parthenogenesis would need an extensive number of individuals from Estonian and Finnish *D. lazuri* and *D. fennicella*. In addition, increasing the number of genes might not always be a good strategy (Hedtke *et al.* 2006) to clarify phylogenetic relationships and the evolution of parthenogenesis.

Although a single transition within *D. fennicella* to parthenogenesis might represent the simplest evolutionary history for bagworm moths, multiple transitions to parthenogenesis are quite common in parthenogenetic species. For instance, multiple transitions have been reported in mitochondrial genes for *Timena* stick insects (Schwander & Crespi 2009), the brine shrimp *Artemia* sp. (Maniatsi *et al.* 2010) and the ostracod *Eucypris virens* (Adolfsson *et al.* 2010, Bode *et al.* 2010). Multiple origins of asexuality were also suggested based on analysis of nuclear genes in *Bryobia* mites (Ros *et al.* 2008).

Possible multiple transitions to parthenogenesis in *D. fennicella* could explain our previous

findings of high genetic diversity in this species (Chevasco *et al.* 2012). Increased genetic diversity resulting from multiple transitions to asexuality was also reported in the geometrid moth *Alsophila pometaria* (Harshman & Futuyama 1985) and in the ostracod *Cypris pubera* (Little 2005). However, genetic diversity in *D. fennicella* might be the result of mutational processes, unlikely alterations to the process of achiasmate oogenesis (Stenberg & Saura 2009), or rare asexual reproduction allowing recombination. However, no records of males exist (Suomalainen 1980) and we are confident that based on their reproductive strategy the individuals we analyzed are true parthenogens.

Hybridization might also originate patterns of genetic diversity due to allopolyploidy (Theisen *et al.* 1995, Delmotte *et al.* 2003). As a result, the confirmed tetraploid status of *D. fennicella* might indicate a hybrid origin. In case of allopolyploidy, the nuclear gene trees would have showed the clustering of *D. fennicella* with its sexual parental species. Therefore, the reconstructed phylogenies of this study revealed that the parthenogenetic *D. fennicella* does not have a hybrid origin. According to the phylogenetic reconstruction of concatenated mitochondrial and nuclear genes we suggest that *D. fennicella* might have evolved from the closely related sexual *D. lazuri*. Although introgression might not occur in the wild, we found that some sexual

species (*D. lazuri*, *D. lichenella* and *S. rupicolella*) are capable of hybridization under laboratory conditions (J. A. Elzinga pers. obs.). If *D. fennicella* were the result of hybridization, the presumable genetically variable parent species might be either extinct or unknown. A limitation of sampling sites does not constitute a feasible explanation, since *D. fennicella* has a limited geographical distribution restricted to Finland and Estonia (Bengtsson *et al.* 2008).

To summarize, we cannot confirm the paraphyletic status of the tetraploid parthenogenetic *D. fennicella*. However, the paraphyletic status of parthenogenetic species has been reported in other asexuals that tend to evolve from sexual forms, such as the mite species of the genus *Bryobia* (Ros *et al.* 2008). In contrast, other asexuals show a polyphyletic status such as in *Daphnia pulex* (Crease *et al.* 1989) the ostracod *Cyprinus incongruens* (Chaplin & Hebert 1997) aphids (Delmotte *et al.* 2001) and the brine shrimp *Artemia* sp. (Maniatsi *et al.* 2010).

Whole genome duplication in *D. fennicella*

We suggest that the parthenogenetic *D. fennicella* possibly originated by means of autopolyploidization of sexual *D. lazuri*. Sexual *D. triquetrella* that purportedly exists in Switzerland (Lokki *et al.* 1975) produces automictic diploids that may originate tetraploid parthenogenetic females through autopolyploidization (Seiler 1964). We speculate that automictic diploids may have originated from *D. lazuri*, producing tetraploid *D. fennicella*. However, no record of automictic diploids in *D. lazuri* exist. Additional support for an autopolyploid origin of *D. fennicella* could be that we found *D. fennicella* to be tetraploid, with approximately twice as much relative DNA when compared with sexual *D. lazuri*. Although double amount of DNA might indicate a hybrid origin, we did not find any evidence for hybridization in *D. fennicella*. Our results might also suggest a recent origin of parthenogenetic *D. fennicella* by autopolyploidization because *D. fennicella* clustered within the same group with *D. lazuri* according to the nuclear *CAD* gene. Alternatively, *D. fennicella* and *D.*

lazuri could have diverged recently due to the low pairwise distances found in *COI*, *COII* and *MDH*. Nonetheless, our findings suggest that *D. fennicella* and *D. triquetrella* are true parthenogenetic species.

Two specific aspects of our results support the conclusion that *D. fennicella* and *D. triquetrella* are two separate species. Firstly, the pairwise sequence divergence value within each cluster of parthenogenetic and sexual species was less than 1%, which reflects a low nucleotide diversity within these species for four genes (two mitochondrial and two nuclear). Furthermore, the sequence divergence between parthenogenetic and sexual groups were at least four times greater than the mean pairwise difference within the parthenogenetic clusters, which follows the 4× rule for asexual speciation. The 4× rule for asexual speciation states that parthenogenetic species constitute independent entities for selection, random drift and mutation (Birky *et al.* 2005, Birky & Barraclough 2009). The fact that parthenogenetic moths can be considered true species, might be due to the increased rates of divergence and speciation that are caused by whole-genome duplications, as previously shown in plants and fish (Van de Peer *et al.* 2009). Regulation of duplicate genes also provides means for diversification and the evolution of adaptive traits in polyploids (Jackson & Chen 2010).

Our findings suggest an autopolyploid origin in *D. fennicella*. Nevertheless, a final conclusion favoring either an allopolyploid or autopolyploid origin would require cytogenetic studies or chromosome mapping (Maniatsi *et al.* 2010). Future investigations could also test the Chenuil *et al.* (1999) hypothesis, which states that in case of autopolyploidy, any genetic marker in the first tetraploid ancestor is represented by two copies (haploid state), whereas in case of allopolyploidy some markers could be absent or display only one copy. The model requires knowledge of the phylogeny of a species descending from the same tetraploidization event, together with the number of homogeneous copies present in each species for a set of neutral markers.

A whole genome duplication event in *D. fennicella* would have helped to reduce extinction risks by creating mutational robustness, functional redundancy, and increased rates of evolu-

tion and adaptation (Crow & Wagner 2006). A polyploid state event might explain the abundance of parthenogenetic species in this group of moths (Kumpulainen *et al.* 2004, Elzinga *et al.* 2011). Whole genome duplication, though, is not the only factor that may contribute to the maintenance of parthenogenesis in bagworm moths. Multiple-male copulations might lead to sperm limitation that could act as a selective force and may have also facilitated the spread of parthenogenesis. However, Elzinga *et al.* (2011) did not find any support for this hypothesis. Another possibility could be the presence of endocellular bacteria (such as *Wolbachia*), but this option was discarded by Kumpulainen *et al.* (2004).

Conclusion

Overall, our study provides greater insight into the apparent success of parthenogenetic species. Our phylogenetic reconstruction indicates that hybridization did not lead to parthenogenesis in *D. fennicella*. We suggest that the most probable origin of parthenogenesis in tetraploid *D. fennicella* is an autopolyploidization event in a closely related sexual species, such as *D. lazuri*. Our findings support the hypothesis that polyploidy benefits parthenogenetic species by preventing the effects of deleterious mutations and generating greater levels of genetic variation. However, a polyploid state in parthenogenetic species might only be a short-term evolutionary-stable strategy favoring the prevalence of sex. Future research could include additional species (e.g. *Luffia* sp. and *Apterona* sp.) to broaden our understanding of the origin and the evolution of parthenogenesis.

Acknowledgements

The authors thank Jukka Jokela, Kirsten Klappert and Dunja Lamatsch for guidance with flow cytometry measurements. Niklas Wahlberg helped with specific CAD primers for the Naryciinae. Also, we would like to thank Sari Viinikainen, Kaisa Suisto and Roghaieh Ashrafi for laboratory assistance at the University of Jyväskylä, Finland. VC wishes to thank Emily Knott for comments and fruitful discussion. We thank Robert Hegna for help with language and computing facilities. The members of the Journal Club (Robert Hegna, Matti

Kervinen, Kaisa Rokka and Carl Soulsbury) also provided comments on an earlier version of the MS. Additionally, we thank two anonymous referees for constructive comments on the MS. This work was funded by Academy of Finland project no. 116892 to AG.

References

- Adolfsson, S., Michalakis, Y., Paczesniak, D., Bode, S. N. S., Butlin, R. K., Lamatsch, D. K., Martins, M. J. F., Schmit, O., Vandekerckhove, J. & Jokela, J. 2010: Evaluation of elevated ploidy and asexual reproduction as alternative explanations for geographic parthenogenesis in *Eucypris virens* ostracods. — *Evolution* 64: 986–997.
- Asker, S. E. & Jerling, L. 1992: *Apomixis in plants*. — CRC Press Inc., Boca Raton, Florida United States of America.
- Bell, G. 1982: *The masterpiece of nature: the evolution and genetics of sexuality*. — Biddles Ltd., Guildford and King's Lynn, Great Britain.
- Bengtsson, B. Å., Palmqvist, G. & Johansson, R. 2008: *Nationalnyckeln till Sveriges flora och fauna. DE 1–13, Fjärilar: Käkmalar – säckspinnare. Lepidoptera: Micropterigidae–Psychidae*. — Artdatabanken, Sveriges lantbruksuniversitet, Uppsala.
- Bennett, M. D., Leitch, I. J., Price, H. J. & Johnston, J. S. 2003: Comparisons with *Caenorhabditis* (~100 Mb) and *Drosophila* (~175 Mb) using flow cytometry show genome size in *Arabidopsis* to be ~157 Mb and thus ~25% larger than the *Arabidopsis* Genome Initiative estimate of ~125 Mb. — *Annals of Botany* 91: 547–557.
- Birky, C. W. & Barraclough, T. G. 2009: Asexual speciation. — In: Schön, I., Martens, K. & van Dijk, P. (eds.), *Lost sex. The evolutionary biology of parthenogenesis*, 1st ed.: 201–216. Springer Science+Business Media B.V., Dordrecht, The Netherlands.
- Birky, C. W., Wolf, C., Maughan, H., Herbertson, L. & Henry, E. 2005: Speciation and selection without sex. — *Hydrobiologia* 546: 29–45.
- Birky, C. 1999: An even broader perspective on sex and recombination. — *Journal of Evolutionary Biology* 12: 1013–1016.
- Blackman, R. L., Spence, J. M. & Normark, B. B. 2000: High diversity of structurally heterozygous karyotypes and rDNA arrays in parthenogenetic aphids of the genus *Trama* (Aphididae: Lachninae). — *Heredity* 84: 254–260.
- Bode, S., Adolfsson, S., Lamatsch, D., Martins, M., Schmit, O. & Vandekerckhove, J. 2010: Exceptional cryptic diversity and multiple origins of parthenogenesis in a freshwater ostracod. — *Molecular Phylogenetics and Evolution* 54: 542–552.
- Boussau, B. & Daubin, V. 2010: Genomes as documents of evolutionary history. — *Trends in Ecology & Evolution* 25: 224–232.
- Chaplin, J. A. & Hebert, P. D. N. 1997: *Cyprinotus incongruens* (Ostracoda): an ancient asexual? — *Molecular Ecology* 6: 155–168.

- Chenuil, A., Galtier, N. & Berrebi, P. 1999: A test of the hypothesis of an autopolyploid vs. allopolyploid origin for a tetraploid lineage: application to the genus *Barbus* (Cyprinidae). — *Heredity* 82: 373–380.
- Chevasco, V., Elzinga, J. A., Viinikainen, S. M., Mappes, J. & Galarza, J. A. 2012: Unexpected genetic variability in the parthenogenetic bag worm moth *Dahlica fennicella* (Lepidoptera: Psychidae) revealed by novel microsatellite markers. — *Conservation Genetics Resources* 4: 159–162.
- Comai, L. 2005: The advantages and disadvantages of being polyploid. — *Nature Reviews Genetics* 6: 836–846.
- Crease, T. J., Stanton, D. J. & Hebert, P. D. N. 1989: Polyphyletic origins of asexuality in *Daphnia pulex*. II. Mitochondrial-DNA variation. — *Evolution* 43: 1016–1026.
- Crow, J. F. 1999: The omnipresent process of sex. — *Journal of Evolutionary Biology* 12: 1023–1025.
- Crow, K. D. & Wagner, G. P. 2006: What is the role of genome duplication in the evolution of complexity and diversity? — *Molecular Biology and Evolution* 23: 887–892.
- Darriba, D., Taboada, G. L., Doallo, R. & Posada, D. 2012: jModelTest 2: more models, new heuristics and parallel computing. — *Nature Methods* 9: 772–772.
- Dasmahapatra, K. K., Walters, J. R., Briscoe, A. D., Davey, J. W., Whibley, A., Na deau, N. J., Zimin, A. V., Hughes, D. S. T., Ferguson, L. C. & Martin, S. H. 2012: Butterfly genome reveals promiscuous exchange of mimicry adaptations among species. — *Nature* 487: 94–98.
- Delmotte, F., Leterme, N., Bonhomme, J., Rispe, C. & Simon, J. C. 2001: Multiple routes to asexuality in an aphid species. — *Proceedings of the Royal Society of London* 268: 2291–2299.
- Delmotte, F., Sabater-Muñoz, B., Prunier-Leterme, N., Latorre, A., Sunnucks, P., Rispe, C. & Simon, J. C. 2003: Phylogenetic evidence for hybrid origins of asexual lineages in an aphid species. — *Evolution* 57: 1291–1303.
- Elzinga, J. A., Chevasco, V., Grapputo, A. & Mappes, J. 2011: Influence of male mating history on female reproductive success among monandrous Naryciinae (Lepidoptera: Psychidae). — *Ecological Entomology* 36: 170–180.
- Foighil, D. O. & Smith, M. J. 1995: Evolution of asexuality in the cosmopolitan marine clam *Lasaea*. — *Evolution* 49: 140–150.
- Fournier, D. & Aron, S. 2009: Evolution: no-male's land for an Amazonian ant. — *Current Biology* 19: R738–R740.
- Grapputo, A., Kumpulainen, T. & Mappes, J. 2005: Phylogeny and evolution of parthenogenesis in Finnish bagworm moth species (Lepidoptera: Psychidae: Naryciinae) based on mtDNA-markers. — *Annales Zoologici Fennici* 42: 141–160.
- Gregory, T. R. & Hebert, P. D. N. 2003: Genome size variation in lepidopteran insects. — *Canadian Journal of Zoology* 81: 1399–1405.
- Gregory, T. & Johnston, J. 2008: Genome size diversity in the family Drosophilidae. — *Heredity* 101: 228–238.
- Guindon, S., Delsuc, F., Dufayard, J.-F. & Olivier Gascuel, O. 2009: Estimating maximum likelihood phylogenies with PhyML. — *Methods in Molecular Biology* 537: 113–137.
- Hall, B. 2011: *Phylogenetic trees made easy: a how-to manual*. — Sinauer Associates Inc., Sunderland, Massachusetts, USA.
- Harshman, L. G. & Futuyma, D. J. 1985: The origin and distribution of clonal diversity in *Alsophila pometaria* (Lepidoptera: Geometridae). — *Evolution* 39: 315–324.
- Hasegawa, M., Kishino, H. & Yano, T. 1985: Dating of the human-ape splitting by a molecular clock of mitochondrial DNA. — *Journal of Molecular Evolution* 22: 160–174.
- Hedtke, S. M., Townsend, T. M. & Hillis, D. M. 2006: Resolution of phylogenetic conflict in large data sets by increased taxon sampling. — *Systematic Biology* 55: 522–529.
- Hillis, D. M. & Bull, J. J. 1993: An empirical test of bootstrapping as a method for assessing confidence in phylogenetic analysis. — *Systematic Biology* 42: 182.
- Hörandl, E. 2009: A combinatorial theory for the maintenance of sex. — *Heredity* 103: 445–457.
- Innes, D. J. & Hebert, P. D. N. 1988: The origin and genetic basis of obligate parthenogenesis in *Daphnia pulex*. — *Evolution* 42: 1024–1035.
- Jackson, S. & Chen, Z. J. 2010: Genomic and expression plasticity of polyploidy. — *Current Opinion in Plant Biology* 13: 153–159.
- Jiggins, C. D., Mavarez, J., Beltrán, M., McMillan, W. O., Johnston, J. S. & Bermingham, E. 2005: A genetic linkage map of the mimetic butterfly *Heliconius melpomene*. — *Genetics* 171: 557–570.
- Johnson, S. G. 2006: Geographic ranges, population structure, and ages of sexual and parthenogenetic snail lineages. — *Evolution* 60: 1417–1426.
- Kimura, M. 1980: A simple method for estimating evolutionary rates of base substitutions through comparative studies of nucleotide sequences. — *Journal of Molecular Evolution* 16: 111–120.
- Kumpulainen, T., Grapputo, A. & Mappes, J. 2004: Parasites and sexual reproduction in psychid moths. — *Evolution* 58: 1511–1520.
- Lanave, C., Preparata, G., Saccone, C. & Serio, G. 1984: A new method for calculating evolutionary substitution rates. *Journal of Molecular Evolution* 20: 86–93.
- Little, T. J. 2005: Genetic diversity and polyploidy in the cosmopolitan asexual ostra cod *Cypris pubera*. — *Journal of Plankton Research* 27: 1287.
- Lokki, J., Suomalainen, E., Saura, A. & Lankinen, P. 1975: Genetic polymorphism and evolution in parthenogenetic animals. II. Diploid and polyploid *Solenobia triquetrella* (Lepidoptera: Psychidae). — *Genetics* 79: 513.
- Mable, B. 2004: “Why polyploidy is rarer in animals than in plants”: myths and mechanisms. — *Biological Journal of the Linnean Society* 82: 453–466.
- Maniatis, S., Baxevanis, A. D., Kappas, I., Deligiannidis, P., Triantafyllidis, A., Papakostas, S., Bougiouklis, D. & Abatzopoulos, T. J. 2010: Is polyploidy a persevere ring accident or an adaptive evolutionary pattern? The case of the brine shrimp *Artemia*. — *Molecular Phylogenetics and Evolution* 58: 353–364.

- Mark Welch, J. L. & Meselson, M. 1998: Karyotypes of bdelloid rotifers from three families. — *Hydrobiologia* 387: 403–407.
- Muller, H. 1964: The relation of recombination to mutational advance. — *Mutation Research/Fundamental and Molecular Mechanisms of Mutagenesis* 1: 2–9.
- Mutanen, M., Wahlberg, N. & Kaila, L. 2010: Comprehensive gene and taxon cover elucidates radiation patterns in moths and butterflies. — *Proceedings of the Royal Society B* 277: 2839–2848.
- Otto, S. P. & Whitton, J. 2000: Polyploid incidence and evolution. — *Annual Review of Genetics* 34: 401–437.
- Parker, E. D. Jr. & Niklasson, M. 2000: Genetic structure and evolution in parthenogenetic animals. — In: Singh, R. S. & Krimbas, C. B. (eds.), *Evolutionary genetics: from molecules to morphology*: 456–474. Cambridge University Press, Cambridge.
- Posada, D. & Crandall, K. A. 1998: Modeltest: testing the model of DNA substitution. — *Bioinformatics* 14: 817–818.
- Provencher, L. M., Morse, G. E., Weeks, A. R. & Normark, B. B. 2005: Parthenogenesis in the *Aspidiotus nerii* complex (Hemiptera: Diaspididae): a single origin of a worldwide, polyphagous lineage associated with *Cardinium* bacteria. — *Annals of the Entomological Society of America* 98: 629–635.
- Ratnasingham, S. & Hebert, P. D. N. 2007: BOLD: The Barcode of Life Data System. — *Molecular Ecology Notes* 7: 355–364. [available at <http://www.barcodinglife.org>]
- Rhainds, M., Davis, D. R. & Price, P. W. 2009: Bionomics of bagworms (Lepidoptera: Psychidae). — *Annual Review of Entomology* 54: 209–226.
- Rice, W. R. & Friberg, U. 2009: A graphical approach to lineage selection between clonals and sexuals. — In: Schön, I., Martens, K. & van Dijk, P. (eds.), *Lost sex. The evolutionary biology of parthenogenesis*, 1st ed.: 75–97. Springer Science+Business Media B.V., Dordrecht, The Netherlands.
- Ronquist, F., Teslenko, M., van der Mark, P., Ayres, D. L., Darling, A., Höhna, S., Larget, B., Liu, L., Suchard, M. A. & Huelsenbeck, J. P. 2012: MrBayes 3.2: efficient Bayesian phylogenetic inference and model choice across a large model space. — *Systematic Biology* 61: 539–542.
- Ros, V., Breeuwer, J. & Menken, S. 2008: Origins of asexuality in *Bryobia* mites (Acari: Tetranychidae). — *BMC Evolutionary Biology* 8: 153.
- Gregory, T. R. 2002: Genome size and developmental complexity. — *Genetica* 115: 131–146.
- Satler, J. D., Starrett, J., Hayashi, C. Y. & Hedin, M. 2011: Inferring species trees from gene trees in a radiation of California trapdoor spiders (Araneae, Antrodiaetidae, *Aliatypus*). — *PloS one* 6: e25355, doi:10.1371/journal.pone.0025355.
- Scali, V. 2009: Metasexual stick insects: model pathways to losing sex and bringing it back. — In: Schön, I., Martens, K. & van Dijk, P. (eds.), *Lost sex. The evolutionary biology of parthenogenesis*, 1st ed.: 317–345. Springer Science+Business Media B.V., Dordrecht, The Netherlands.
- Schurko, A. M., Neiman, M. & Logsdon, J. M. Jr. 2009: Signs of sex: what we know and how we know it. — *Trends in Ecology & Evolution* 24: 208–217.
- Schwander, T. & Crespi, B. J. 2009: Multiple direct transitions from sexual reproduction to apomictic parthenogenesis in *Timema* stick insects. — *Evolution* 63: 84–103.
- Seiler, J. 1961: Untersuchungen über die Entstehung der Parthenogenese bei *Solenobia triquetrella* FR (Lepidoptera, Psychidae). — *Molecular and General Genetics MGG* 92: 261–316.
- Seiler, J. 1964: Untersuchungen über die Entstehung der Parthenogenese bei *Solenobia triquetrella* FR (Lepidoptera, Psychidae). — *Chromosoma* 15: 503–539.
- Shinohara, W., Ushio, Y., Seo, A., Nakato, N., Kono, M., Kudoh, H., Tobe, H. & Murakami, N. 2010: Evidence for hybrid origin and segmental allopolyploidy in eutetraploid and aneutetraploid *Lepisorus thunbergianus* (Polypodiaceae). — *Systematic Botany* 35: 20–29.
- Simon, C., Frati, F., Beckenbach, A., Crespi, B., Liu, H. & Flook, P. 1994: Evolution, weighting, and phylogenetic utility of mitochondrial gene sequences and a compilation of conserved polymerase chain reaction primers. — *Annals of the Entomological Society of America* 87: 651–701.
- Simon, J. C., Delmotte, F., Rispe, C. & Crease, T. 2003: Phylogenetic relationships between parthenogens and their sexual relatives: the possible routes to parthenogenesis in animals. — *Biological Journal of the Linnean Society* 79: 151–163.
- Stenberg, P. & Lundmark, M. 2004: Distribution, mechanisms and evolutionary significance of clonality and polyploidy in weevils. — *Agricultural and Forest Entomology* 6: 259–266.
- Stenberg, P. & Saura, A. 2009: Cytology of Asexual Animals. — In: Schön, I., Martens, K. & van Dijk, P. (eds.), *Lost sex. The evolutionary biology of parthenogenesis*, 1st ed.: 63–74. Springer Science+Business Media B.V., Dordrecht, The Netherlands.
- Sobczyk, T. 2011: *World catalogue of insects 10: Psychidae (Lepidoptera)*. — Apollo Books Aps., Denmark.
- Suomalainen, E. 1980: The Solenobiinae species of Finland (Lepidoptera: Psychidae), with a description of a new species. — *Insect Systematics and Evolution* 11: 458–466.
- Suomalainen, E., Saura, A. & Lokki, J. 1987: *Cytology and evolution in parthenogenesis*. — CRC Press, Boca Raton, FL, USA.
- Tamura, K., Peterson, D., Peterson, N., Stecher, G., Nei, M. & Kumar, S. 2011: ME GA5: molecular evolutionary genetics analysis using maximum likelihood, evolutionary distance, and maximum parsimony methods. — *Molecular Biology and Evolution* 28: 2731–2739.
- Taylor, M., Zawadzki, J., Black, B. & Kreitman, M. 1993: Genome size and endopolyploidy in pyrethroid-resistant and susceptible strains of *Heliothis virescens* (Lepidoptera: Noctuidae). — *Journal of Economic Entomology* 86: 1030–1034.
- Theisen, B. F., Christensen, B. & Arctander, P. 1995: Origin of clonal diversity in tri ploid parthenogenetic *Tricho-*

- niscus pusillus pusillus* (Isopoda, Crustacea) based upon allozyme and nucleotide sequence data. — *Journal of Evolutionary Biology* 8: 71–80.
- Tobler, A., Kapan, D., Flanagan, N., Gonzalez, C., Peterson, E., Jiggins, C., Johnstone, J., Heckel, D. & McMillan, W. 2004: First-generation linkage map of the warningly colored butterfly *Heliconius erato*. — *Heredity* 94: 408–417.
- Rees, D. J., Dufresne, F., Glémet, H. & Belzile, C. 2007: Amphipod genome sizes: first estimates for Arctic species reveal genomic giants. — *Genome* 50: 151–158.
- Tsutsui, N., Suarez, A., Spagna, J. & Johnston, J. S. 2008: The evolution of genome size in ants. — *BMC Evolutionary Biology* 8: 64.
- Van de Peer, Y., Maere, S. & Meyer, A. 2009: The evolutionary significance of ancient genome duplications. — *Nature Reviews Genetics* 10: 725–732.
- Wahlberg, N. & Wheat, C. W. 2008: Genomic outposts serve the phylogenomic pioneers: designing novel nuclear markers for genomic DNA extractions of Lepidoptera. — *Systematic Biology* 57: 231–242.
- Weeks, A. R., Marec, F. & Breeuwer, J. A. J. 2001: A mite species that consists entirely of haploid females. — *Science* 292: 2479.
- Weiss-Schneeweiss, H., Greilhuber, J. & Schneeweiss, G. M. 2005: Genome size evolution in holoparasitic *Orobanchae* (Orobanchaceae) and related genera. — *American Journal of Botany* 93: 148–156.
- White, M. 1973: *Animal cytology and evolution*. — Cambridge University Press, Cambridge, Cambridge, UK.
- Zhan, S., Merlin, C., Boore, J. L. & Reppert, S. M. 2011: The monarch butterfly genome yields insights into long-distance migration. — *Cell* 147: 1171–1185.
- Zharkikh, A. 1994: Estimation of evolutionary distances between nucleotide sequences. — *Journal of Molecular Evolution* 39: 315–329.

Appendix

Phylogenetic Inference

Phylogenetic relationships were also reconstructed using Maximum Likelihood. The separate gene trees were estimated based on the same models that were used for Bayesian inference. However, due to the limitation of the program to specify different substitution models for each gene in concatenated trees, we used the same model for the mitochondrial (GTR + Γ) and for the four gene fragments (GTR + I + Γ). The phylogenetic tree topology was based on a SPR approach (subtree pruning and regrafting), while the branch support had a bootstrap test of 100 replicates. According to the default settings, the starting trees were based on BIONJ. A bootstrap value above 70% was considered to significantly support taxonomic relationships (Hillis & Bull 1993). As in Bayesian inference, the heterozygous sites of the nuclear genes were left unphased. Ambiguous characters are ignored in PhyML due to the lack of phylogenetic information.

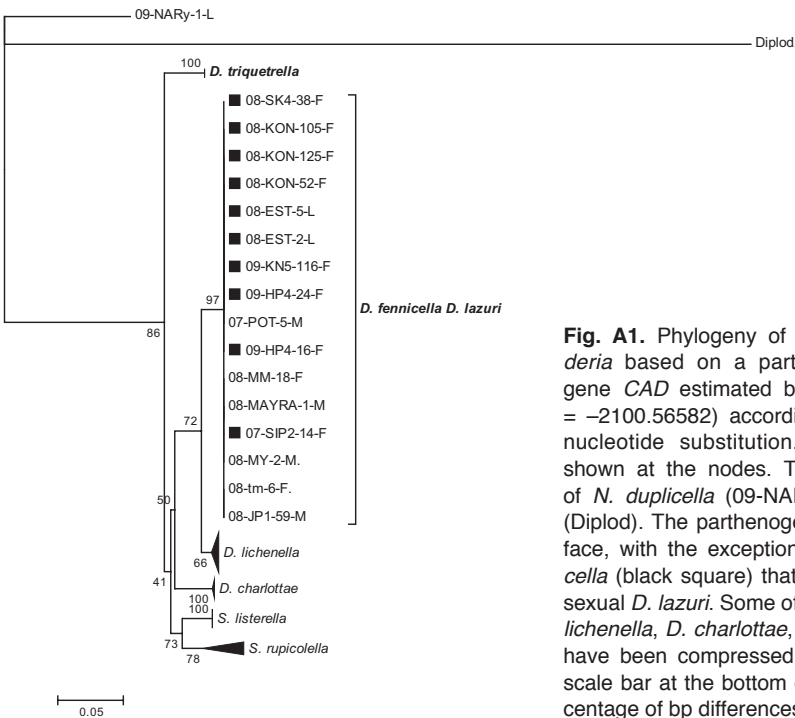

Fig. A1. Phylogeny of the genera *Dahlicia* and *Siederia* based on a partial sequence of the nuclear gene *CAD* estimated by Maximum Likelihood (LogL = -2100.56582) according to the GTR + I model of nucleotide substitution. The bootstrap values are shown at the nodes. The outgroups are sequences of *N. duplicella* (09-NARy-1-L) and *D. laichartingella* (Diplod). The parthenogenetic species are set in bold-face, with the exception of parthenogenetic *D. fennicella* (black square) that shares the same cluster with sexual *D. lazuri*. Some of the clusters (*D. triquetrella*, *D. lichenella*, *D. charlottae*, *S. rupicolella* and *S. listerella*) have been compressed in order to save space. The scale bar at the bottom of each tree indicates the percentage of bp differences.

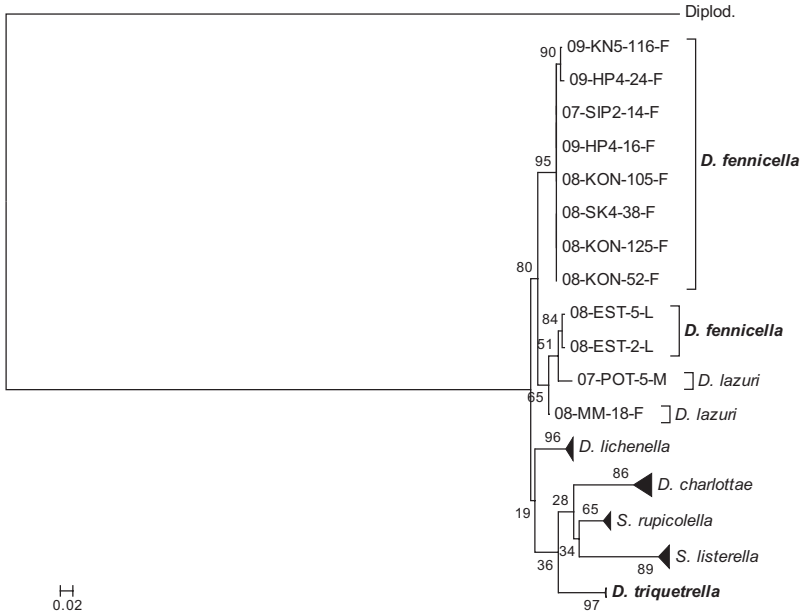

Fig. A2. Phylogeny of the genera *Dahlica* and *Siederia* based on a partial sequence of the nuclear gene *MDH* estimated by Maximum Likelihood (B) ($\text{Log}L = -2677.04697$) according to the SYM + I + Γ model of nucleotide substitution. The bootstrap values are shown at the nodes of the tree. The outgroup is a sequence of *D. laichartingella* (Diplod). The parthenogenetic species are set in boldface. Some of the clusters (*D. triquetrella*, *D. lichenella*, *D. charlottae*, *S. rupicolella* and *S. listerella*) have been compressed in order to save space. The scale bar at the bottom of each tree indicates the percentage of bp differences.

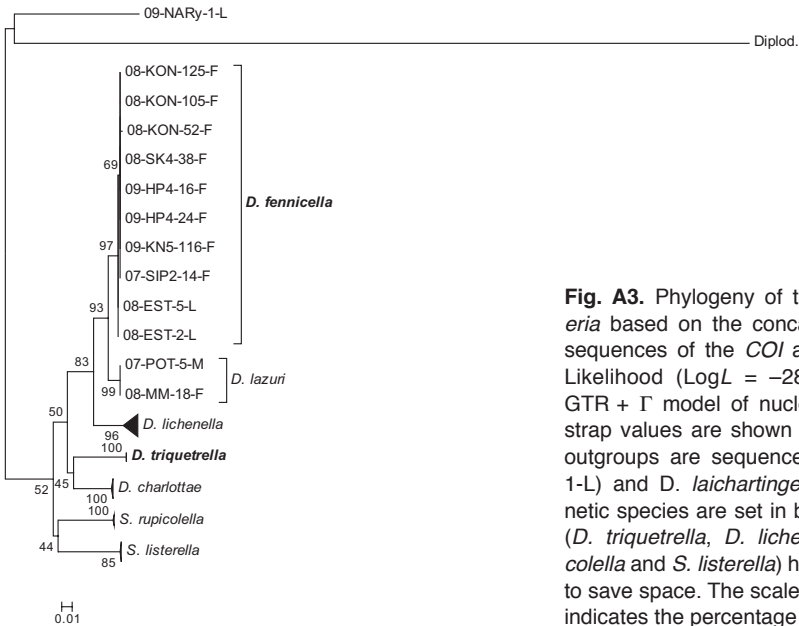

Fig. A3. Phylogeny of the genera *Dahlica* and *Siederia* based on the concatenated partial mitochondrial sequences of the *COI* and *COII* estimated Maximum Likelihood ($\text{Log}L = -2861.88975$) according to the GTR + Γ model of nucleotide substitution. The bootstrap values are shown at the nodes of the tree. The outgroups are sequences of *N. duplicella* (09-NARy-1-L) and *D. laichartingella* (Diplod). The parthenogenetic species are set in boldface. Some of the clusters (*D. triquetrella*, *D. lichenella*, *D. charlottae*, *S. rupicolella* and *S. listerella*) have been compressed in order to save space. The scale bar at the bottom of each tree indicates the percentage of bp differences.

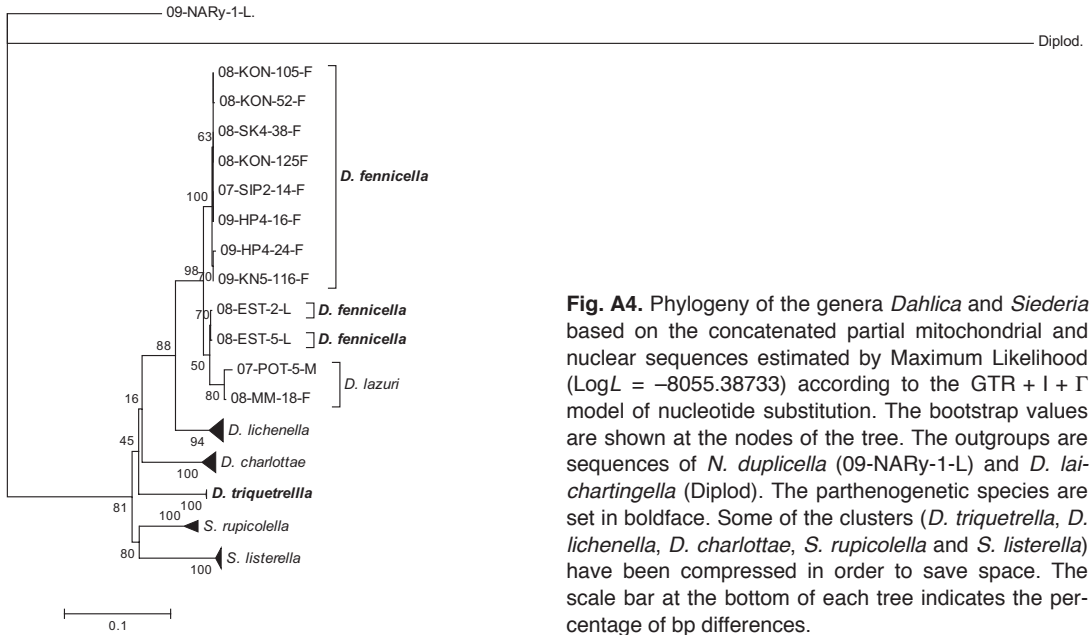

Fig. A4. Phylogeny of the genera *Dahlica* and *Siederia* based on the concatenated partial mitochondrial and nuclear sequences estimated by Maximum Likelihood (LogL = -8055.38733) according to the GTR + I + Γ model of nucleotide substitution. The bootstrap values are shown at the nodes of the tree. The outgroups are sequences of *N. duplicella* (09-NARy-1-L) and *D. laichartingella* (Diplod). The parthenogenetic species are set in boldface. Some of the clusters (*D. triquetrella*, *D. lichenella*, *D. charlottae*, *S. rupicolella* and *S. listerella*) have been compressed in order to save space. The scale bar at the bottom of each tree indicates the percentage of bp differences.

Species Identification based on DNA barcoding

We identified the individuals to species based on the partial sequence of the cytochrome oxidase subunit II gene (*COII*). We used the Kimura 2 parameter (K2P) as a model of nucleotide substitution (Kimura 1980) based on the barcoding protocol (Ratnasingham & Hebert 2007). A neighbour-joining (NJ) tree was obtained using MEGA ver. 5.0 (Tamura *et al.* 2011). We identified the individuals according to their position in different clusters that contained sequences from a reference collection available in the GenBank (Grapputo *et al.* 2005). The reliability of the tree was evaluated with a bootstrap test with 500 replicates. A sequence from *Narycia duplicella* was included as the out group.

Some *D. lazuri* individuals collected in 2011 were identified based on the *COI* gene. We determined, though, that identification based on either one of the subunits of the cytochrome-oxidase gene was equivalent for DNA barcoding purposes. Thus, we obtained the same species-specific clusters for *COII* and *COI*. Genetic distances among the species were calculated as the K2P pairwise sequence divergence (Table 3). The intraspecific distances for *COII* were less than 1%. The interspecific distances grouped the species of the genus *Dahlica* in a single but weakly supported cluster (42%). Within the genus *Dahlica*, *D. fennicella*, *D. lazuri* and *D. lichenella* formed a well-supported group (91%). The group of *D. lichenella* was also well supported (76%). Within this cluster, sexual *D. lazuri* and parthenogenetic *D. fennicella* had the lowest interspecific pairwise distance (1.5%). On the other hand, parthenogenetic *D. triquetrella* (bootstrap: 30% weak cluster support) showed the lowest divergence with sexual *D. charlottae* (3.2%). The highest level of divergence in the genus *Dahlica* was found between *D. charlottae* and *D. lichenella* (5.8%). The species of the genus *Siederia* (*S. listerella* and *S. rupicolella*) did not form a single group. The cluster of *S. listerella* was better supported (bootstrap: 99%) when compared with the one of *S. rupicolella* (bootstrap: 64%). When comparing the genus *Siederia* with *Dahlica* the highest level of divergence was found between *S. listerella* and *D. lichenella* (6.7%). In contrast, *D. fennicella* and *D. lazuri* showed the lowest pairwise distance (4.7%) when compared with *S. rupicolella*.

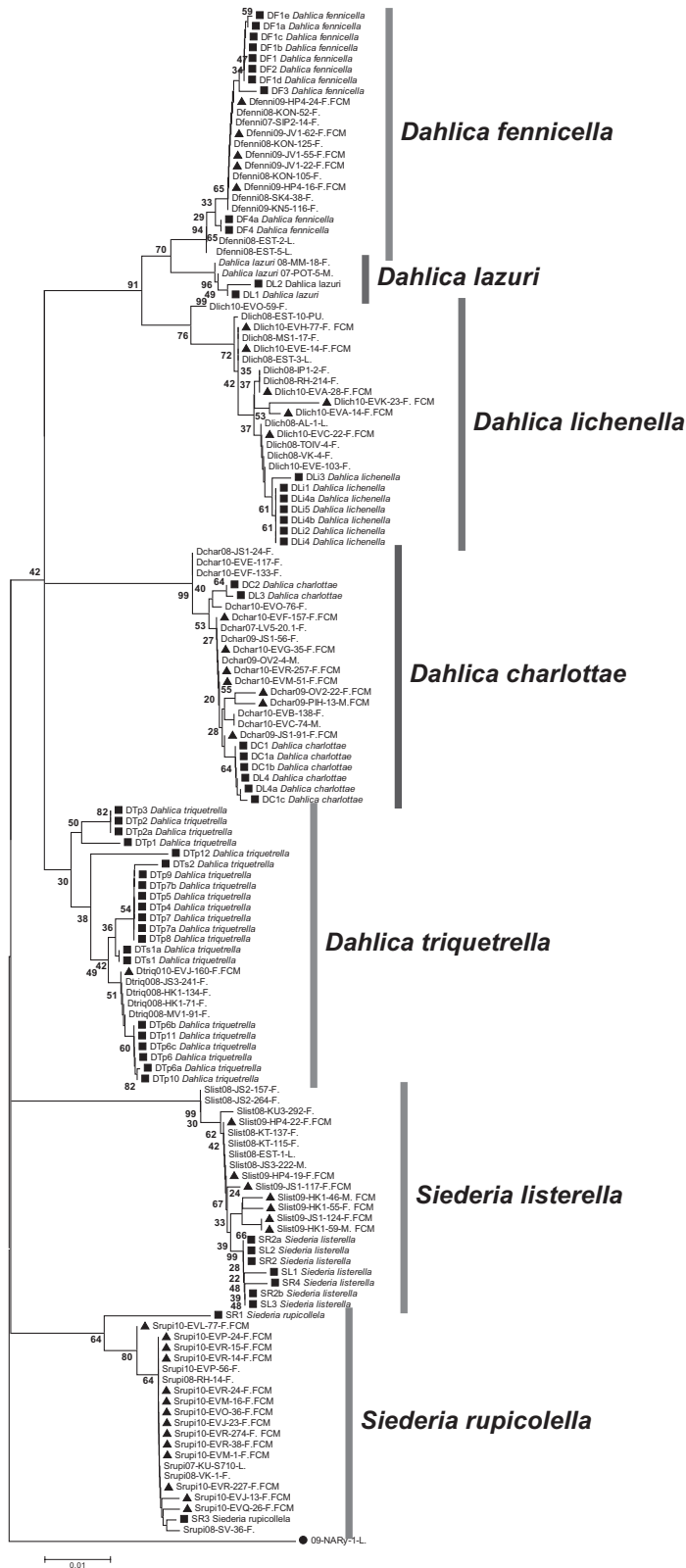

Fig. A5. Neighbour-joining phylogenetic tree based on K2P, pairwise deletion and bootstrap test of 500 replications for the seven species of bagworm moths. Bootstrap values are indicated next to each node. The phylogenetic tree includes a reference sequence of *Narycia duplicella* as an outgroup (black circles). Each sample name indicates the moth species: (Dlich = *D. lichenella*, Dlaz = *D. lazuri*, Dfenni = *D. fennicella*, Dtriq = *D. triquetrella*, Dchar = *D. charlottae*, Slist = *S. listerella*, Srupi = *S. rupicolella*). The reference sequences (Grapputo *et al.* 2005) are indicated with black squares. The tree also includes individuals that were used for flow cytometry measurements (black triangles). The scale bar at the bottom of each tree indicates the percentage of bp differences.