

This is a self-archived version of an original article. This version may differ from the original in pagination and typographic details.

Author(s): Slupecki, Maciej

Title: Fast Interaction Trigger for ALICE upgrade

Year: 2022

Version: Published version

Copyright: © 2022 the Authors

Rights: CC BY 4.0

Rights url: <https://creativecommons.org/licenses/by/4.0/>

Please cite the original version:

Slupecki, M. (2022). Fast Interaction Trigger for ALICE upgrade. Nuclear Instruments and Methods in Physics Research Section A: Accelerators, Spectrometers, Detectors and Associated Equipment, 1039, Article 167021. <https://doi.org/10.1016/j.nima.2022.167021>



Fast Interaction Trigger for ALICE upgrade

Maciej Slupecki, on behalf of the ALICE Collaboration

Helsinki Institute of Physics (HIP), University of Helsinki, P.O. Box 64, 00014, Finland
Department of Physics, University of Jyväskylä, P.O. Box 35, FI-40014, Finland

ARTICLE INFO

MSC:
00-01
99-00

Keywords:
ALICE FIT
Scintillator
Cherenkov detector
Time resolution
Trigger detector
Detector performance

ABSTRACT

We present the structure, functionalities and the first in-beam performance of the ALICE Fast Interaction Trigger (FIT). FIT comprises three detectors: FTO, FVO and FDD, which use Cherenkov and scintillation effects to detect charged particles originating from proton–proton (pp) and heavy-ion collisions. FIT generates triggers for ALICE, monitors luminosity and background, measures collision time, and determines global collision parameters, such as forward multiplicity, centrality and event plane. FIT uses dedicated front-end electronics to measure time and charge of pulses at pp bunch crossing interval of 25 ns and pp (Pb–Pb) interaction rates of up to 1 MHz (50 kHz). FIT has been installed in ALICE, and its commissioning is ongoing. Upon exposition to pp collisions at the LHC injection energy of $E_{\text{CMS}} = 450$ GeV FIT shows good performance in terms of the collision time resolution of 26 ps and the vertex resolution of 0.8 cm. It is important to note that the presented figures reflect the performance of non-calibrated detectors at lower-than-nominal collision energy (13–14 TeV). They are, therefore, expected to improve.

1. Introduction

The LHC Run 3, starting in March 2022, concludes a 3-year long period of Long Shutdown 2 (LS2). LS2 was dedicated to LHC and experiments' upgrades, including ALICE. The physics objectives of ALICE for Run 3 [1] require collecting all minimum-bias events, to exceed by two orders of magnitude the combined Run 1 and 2. It is a major challenge for the detectors' readout electronics and the new data processing framework. Many upgraded ALICE detectors [2] operate in a continuous readout mode (ITS, MFT, ZDC, TOF, MCH, MID, TPC), but some of them (TRD, CPV, HMPID, EMCAL, DCAL, PHOS) require a trigger. Trigger generation is one of the functionalities of the new Fast Interaction Trigger system (FIT) [3–5], which was installed in ALICE during LS2. We present the FIT's structure, functionalities, present status, and latest results coming from LHC pilot pp collisions at $E_{\text{CMS}} = 450$ GeV.

2. Fast Interaction Trigger (FIT)

2.1. Functionalities

FIT will deliver an extensive trigger menu consisting of minimum-bias and centrality-based triggers. It will monitor the collision rate and provide online luminosity feedback to the LHC. In addition, it will monitor the background. FIT data will be used in the following areas:

- **Measurement of precision collision time needed for particle identification based on the time-of-flight (TOF).**

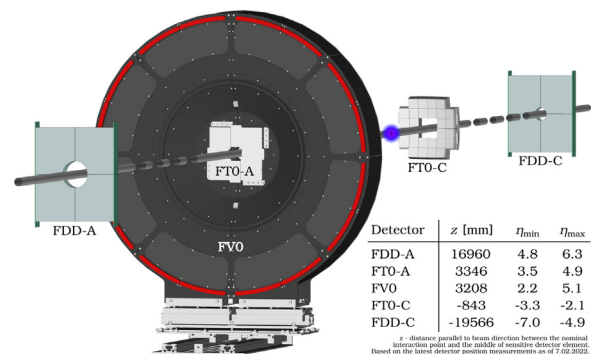

Fig. 1. Layout of FIT detectors. Inset shows the location along the beamline (z) and the pseudorapidity coverage (η) of each detector array.

FIT data are especially important in low-multiplicity events, where the number of particles with velocities close to speed of light c , reaching the TOF detector is too small to reliably calculate the collision time.

- **Determination of global collision parameters based on the forward particle multiplicity: centrality and event plane [6].** As a forward detector FIT detects a different subset of particles originating from the collision than the mid-rapidity detectors. Using two non-overlapping subsets of data helps to avoid bias in many physics analyses that use these global collision parameters.

E-mail address: maciej.slupecki@cern.ch.

<https://doi.org/10.1016/j.nima.2022.167021>

Received 7 April 2022; Accepted 7 June 2022

Available online 21 June 2022

0168-9002/© 2022 The Author(s). Published by Elsevier B.V. This is an open access article under the CC BY license

(<http://creativecommons.org/licenses/by/4.0/>).

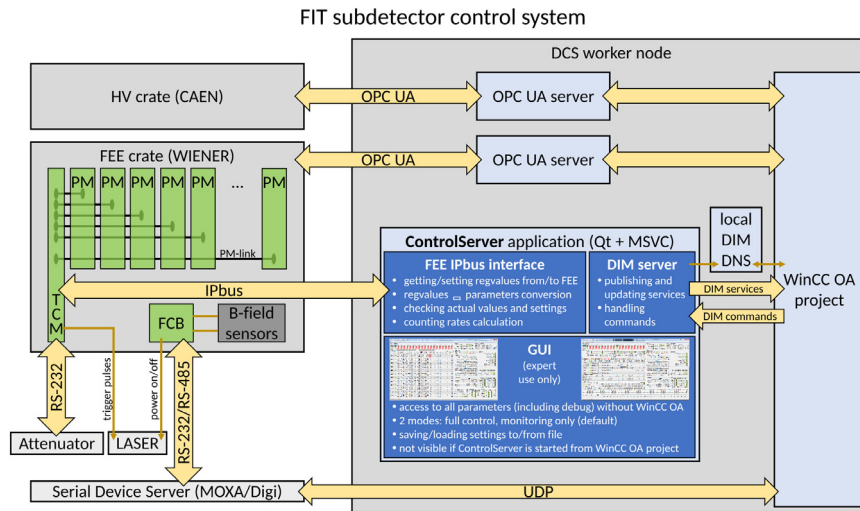

Fig. 2. Schema of the front-end electronics and its interfaces with the detector control system.

• Diffractive physics

FIT is used to recognize processes that are diffractive or induced by photons by tagging the absence of activity in the forward direction.

2.2. Subdetectors

FIT consists of three detectors located in high-rapidity regions:

• FT0

Two Cherenkov arrays on both sides of the interaction point comprise 208 pixels. FT0, as a Cherenkov detector, is fast and insensitive to background signals induced by particles coming from directions other than the collision region. It plays a major role in low-latency, minimum-bias and centrality trigger generation as well as in collision time and vertex position calculations.

• FV0 [7]

A large scintillator ring divided into five rings and eight sectors is located on the opposite side of the hadron absorber of the Muon Spectrometer. Each sector of the outermost ring is read out by two photosensors. Thus, it has 48 channels in total. FV0 utilizes a novel light collection system, avoiding wavelength shifters and improving timing. It is characterized by a reasonable time resolution and low latency. As a scintillator, it is suitable to monitor the background. It improves minimum-bias trigger efficiency and extends the dynamic range available for the centrality-based trigger. Together with FT0, it is important for centrality and event plane determination.

• FDD (Forward Diffractive Detector) [8]

Two double-sided scintillator arrays (16 pixels in total) use a fast state-of-the-art NOL-38 wavelength shifter. FDD is located relatively far away from the interaction point, and because of cable-induced latency, its use as an online trigger detector is limited. However, it is essential for tagging diffractive events and background monitoring.

An overview of the layout, position and pseudorapidity coverage of the FIT detectors is shown in Fig. 1.

2.3. Electronics

FIT uses dedicated front-end electronics (FEE), which is common for all FIT subdetectors [9,10]. It can collect data in a continuous or triggered mode with a bunch-crossing interval down to 25 ns and an average pp (Pb–Pb) interaction rate of 1 MHz (50 kHz).

FIT FEE consists of two types of VME boards: Trigger and Clock Module (TCM) and Processing Module (PM). Each detector uses one TCM and a number of PMs depending on the number of detector channels. One PM can receive and process up to 12 analogue signals directly from detectors' photosensors. Altogether, FT0 uses 18 PMs, FV0 uses 6 PMs, and FDD uses 2 PMs. A schema of the FIT FEE is presented in Fig. 2.

A PM evaluates the incoming signal time using an internal constant fraction discriminator and integrates its charge for 16–21 ns. To avoid the dead time, each PM channel is equipped with two 12-bit ADCs, that work interchangeably: one integrates charge, the other one is being read out, then they swap. Considering the thermal noise level of $\lesssim 3$ mV, maximum input voltage of 2 V, and preference to keep the single-MIP (Minimum Ionizing Particle) detection efficiency close to 100%, a single channel has a dynamic range of up to 250 MIPs. The time resolution (bin width) is 13.02 ps, which is at the level of intrinsic FT0 detector module time resolution of 12 ps, and an order of magnitude better than that of FV0 or FDD. Every PM calculates a pre-trigger solution and sends it to the TCM.

The TCM of every FIT subdetector receives and combines pre-trigger information from PMs and generates final triggers that are sent to ALICE Central Trigger Processor (CTP) where they are further processed and distributed. To guarantee a high level of time accuracy and proper synchronization with the beam, TCMs also distribute a high-quality clock signal, which is based on the LHC clock, throughout the PMs.

Every FEE module (PM and TCM) is connected to the data acquisition system via one GigaBit Transceiver (GBT) optical link [11]. With 4.8 Gb/s data transfer speed per link, the system can transfer, on average, one 128-bit word per bunch crossing. One word contains full information from 2 channels. This means that if the detector occupancy is 1/6th of the total number of channels and the overhead related to the data structure (headers, control sums) is ignored, then FIT FEE could operate at a 40 MHz collision rate. In reality, the overhead cannot be ignored, but the rates of up to 5 MHz could be feasible.

2.4. Commissioning status

All three FIT detectors were successfully installed in ALICE in 2021. Fig. 3 shows the selected FIT detectors (black FV0 ring with FT0-A attached to it in the centre). Presently, FIT detectors are being commissioned. It is already possible to operate them manually. An intensive effort is being put towards automatizing most operations. A full integration with the rest of the ALICE will follow soon.

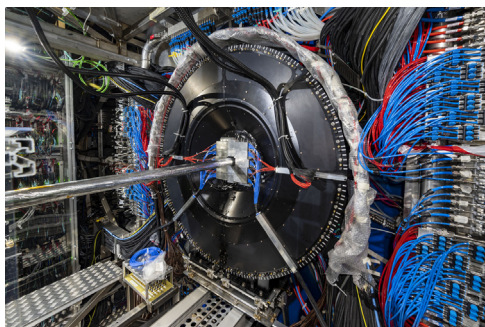

Fig. 3. Photograph of FVO and FT0-A after installation in ALICE.

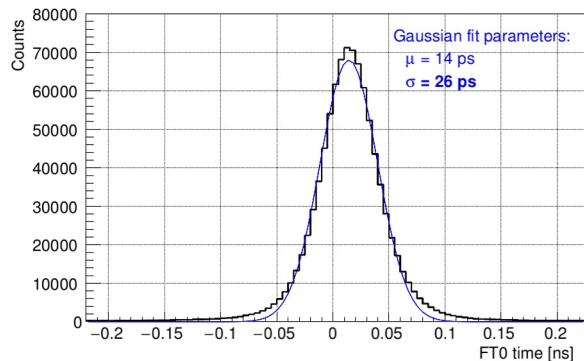

Fig. 4. FT0 collision time resolution.

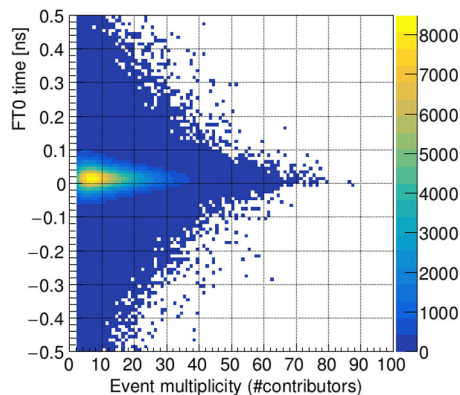

Fig. 5. Collision time distribution as a function of multiplicity.

3. FIT performance

In October 2021 low-intensity pilot pp beams were circulated in the upgraded LHC, and ALICE detected the first collisions at $E_{\text{CMS}} = 450$ GeV. These beams were used to validate the integration and responses of all the ALICE systems, including FIT. FIT uses timing, charge and vertex position criteria to maintain good background rejection when monitoring the luminosity and generating the minimum-bias trigger. Therefore, the most critical performance figures are time and vertex resolution and charge correlation.

As presented in Fig. 4 FT0 shows the time resolution of 26 ps for minimum-bias pp collisions. As expected (Fig. 5), the time resolution is multiplicity-dependent. At low multiplicities, signals can be dominated by non-relativistic particles. The differences in their speeds cause a larger spread in the spectrum. In addition, any background hit is likely to seriously affect the measurement. On the other hand, at large multiplicities, a single pixel is likely hit by many particles, in which

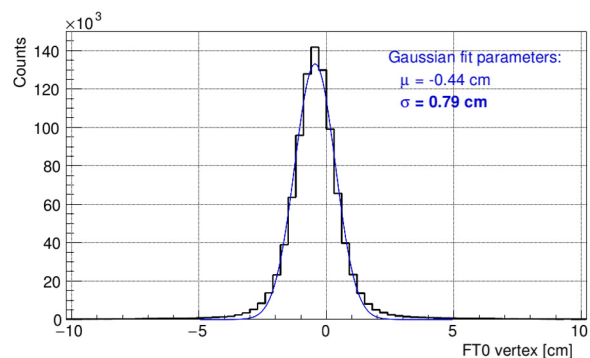

Fig. 6. FT0 vertex resolution.

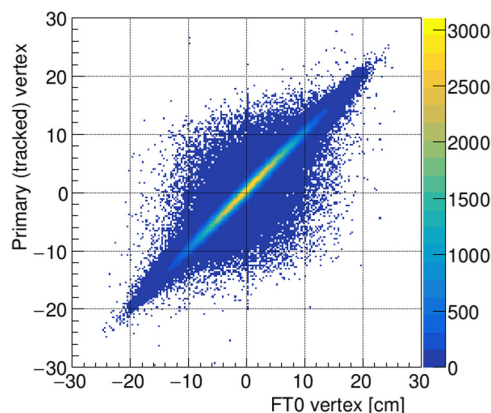

Fig. 7. Correlation between collision vertex reconstructed by the tracking detectors and FT0.

case only the fastest one will contribute to the time measurement, thereby eliminating the effect of non-relativistic particles and much of the background on the measured time.

In the case of FT0, the position of the collision vertex is calculated online event-by-event by using the time difference of two FT0 arrays and assuming that forward particles propagate at the speed of light and are not affected by the magnetic field of the L3 solenoid used by ALICE. The resolution of the FT0 vertex depends on the time resolution of each array and reaches down to 0.8 cm (Fig. 6). The *FT0 vertex* resolution is defined as one-sigma of the distribution of differences between the FT0 vertex and the *primary vertex*, which is reconstructed using silicon-based trackers. Therefore, the *primary vertex* is much more precise, but it is only available offline because it involves complex calculations. The correlation between the two methods of vertex position reconstruction is shown in Fig. 7.

Another important metric to evaluate FIT performance is the efficiency of calculating a valid time, which can be used as a start time for the TOF-based particle identification. Fig. 8 shows it as a function of particle multiplicity for different FIT subdetectors. As expected, the efficiency depends on the particle multiplicity, but it saturates fairly quickly. While the efficiency of FVO is the best thanks to large acceptance, it is plotted only for comparison because its time resolution is not good enough for TOF measurements. The other three configurations are all valid for such a use. The combination of FT0-A & FT0-C time is of the best quality (background-free, the best time resolution), but its efficiency is slightly lower. In collisions, in which only one array registered hits, FT0 can still contribute to the reconstruction of collision time, but it needs external information about the vertex position, which is available only offline, usually from trackers.

An initial, but essential check to confirm the ability of FIT to determine the event multiplicity or centrality is the correlation between

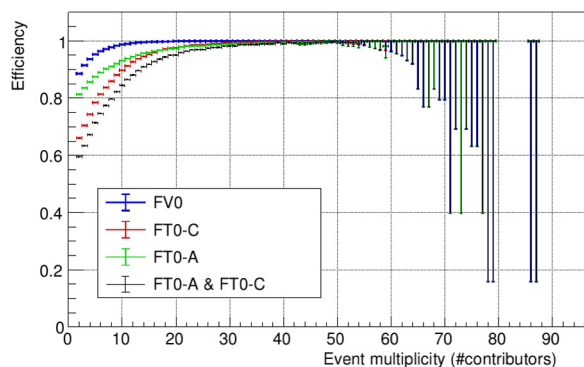

Fig. 8. The efficiency of a valid collision time reconstructed by different combinations of FIT detectors as a function of particle multiplicity.

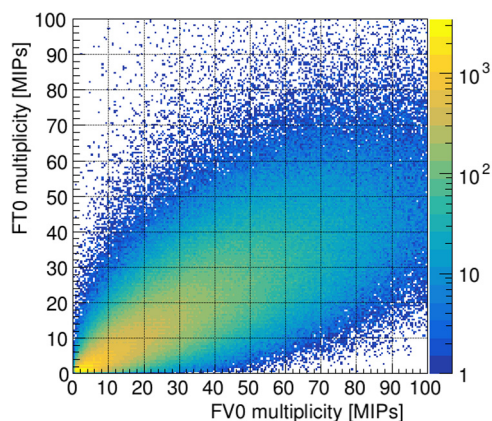

Fig. 9. Correlation between FT0-A and FV0 particle multiplicity.

the sum of measured charges, or the number of Minimum Ionizing Particles (MIPs) in different detectors. An example of the correlation between FT0-A and FV0 is shown in Fig. 9. The slope is less than one because the acceptance of FV0 is larger than that of FT0-A. The large spread is outside of expectations and it is being investigated.

It is important to note that all the presented results show the detector performance without any calibration and at lower-than-nominal collision energy. The calibration is expected to align individual channels, thus decreasing the spread of time and charge spectra combined into all-channel data. Reaching the nominal energy of 13–14 TeV will increase the particle multiplicity per event, thus reducing the relative number of slow particles and their overall effect on time and vertex resolutions.

Declaration of competing interest

The authors declare that they have no known competing financial interests or personal relationships that could have appeared to influence the work reported in this paper.

References

- [1] B. Abelev, ALICE Collaboration, Upgrade of the ALICE experiment: Letter Of Intent, *J. Phys. G* 41 (2014) 087001, <http://dx.doi.org/10.1088/0954-3899/41/8/087001>.
- [2] W.H. Trzaska, ALICE Collaboration, New ALICE detectors for Run 3 and 4 at the CERN LHC, in: M. Krammer, T. Bergauer, M. Dragicevic, M. Friedl, M. Jeitler, J. Schieck, C. Schwanda (Eds.), *Nucl. Instrum. Methods A* 958 (2020) 162116, <http://dx.doi.org/10.1016/j.nima.2019.04.070>.
- [3] M. Slupecki, ALICE Collaboration, Status of the Fast Interaction Trigger for ALICE upgrade, *PoS ICHEP2020* (2021) 779, <http://dx.doi.org/10.22323/1.390.0779>.
- [4] S. Bysiak, The Fast Interaction Trigger upgrade for ALICE, *PoS LHCP2020* (2020) 251, <http://dx.doi.org/10.22323/1.382.0251>.
- [5] W.H. Trzaska, ALICE Collaboration, New Fast Interaction Trigger for ALICE, *Nucl. Instrum. Meth.* A845 (2017) 463–466, <http://dx.doi.org/10.1016/j.nima.2016.06.029>.
- [6] H.M. Rytönen, Event plane determination with the new ALICE FIT detector, *PoS ICHEP2020* (2021) 814, <http://dx.doi.org/10.22323/1.390.0814>.
- [7] V. Grabski, New fiber read-out design for the large area scintillator detectors: providing good amplitude and time resolutions, 2019, [arXiv:1909.01184](https://arxiv.org/abs/1909.01184).
- [8] S. Rojas, The Forward Diffractive Detector for ALICE, *PoS LHCP2020* (2020) 221, <http://dx.doi.org/10.22323/1.382.0221>.
- [9] D. Finogeev, et al., Readout system of the ALICE Fast Interaction Trigger, *JINST* 15 (09) (2020) C09005, <http://dx.doi.org/10.1088/1748-0221/15/09/C09005>.
- [10] D.A. Finogeev, ALICE Collaboration, Fully integrated digital readout for the new Fast Interaction Trigger for the ALICE upgrade, *Nucl. Instrum. Meth.* A952 (2020) 161920, <http://dx.doi.org/10.1016/j.nima.2019.02.047>.
- [11] P. Moreira, et al., The GBT project, 2009, <http://dx.doi.org/10.5170/CERN-2009-006.342>, URL <https://cds.cern.ch/record/1235836>.