

**This is an electronic reprint of the original article.
This reprint *may differ* from the original in pagination and typographic detail.**

Author(s): Hokkanen, Matti; Lautala, S.; Flahaut, E.; Ahlskog, Markus

Title: Experimental studies on the detachment of multi-walled carbon nanotubes by a mobile liquid interface

Year: 2017

Version:

Please cite the original version:

Hokkanen, M., Lautala, S., Flahaut, E., & Ahlskog, M. (2017). Experimental studies on the detachment of multi-walled carbon nanotubes by a mobile liquid interface. *Colloids and Surfaces A: Physicochemical and Engineering Aspects*, 533, 109-115.
<https://doi.org/10.1016/j.colsurfa.2017.08.029>

All material supplied via JYX is protected by copyright and other intellectual property rights, and duplication or sale of all or part of any of the repository collections is not permitted, except that material may be duplicated by you for your research use or educational purposes in electronic or print form. You must obtain permission for any other use. Electronic or print copies may not be offered, whether for sale or otherwise to anyone who is not an authorised user.

Accepted Manuscript

Title: Experimental studies on the detachment of multi-walled carbon nanotubes by a mobile liquid interface

Author: M.J. Hokkanen S. Lautala E. Flahaut M. Ahlskog

PII: S0927-7757(17)30797-5

DOI: <http://dx.doi.org/doi:10.1016/j.colsurfa.2017.08.029>

Reference: COLSUA 21891

To appear in: *Colloids and Surfaces A: Physicochem. Eng. Aspects*

Received date: 3-3-2017

Revised date: 23-8-2017

Accepted date: 23-8-2017

Please cite this article as: M.J. Hokkanen, S. Lautala, E. Flahaut, M. Ahlskog, Experimental studies on the detachment of multi-walled carbon nanotubes by a mobile liquid interface, *Colloids and Surfaces A: Physicochemical and Engineering Aspects* (2017), <http://dx.doi.org/10.1016/j.colsurfa.2017.08.029>

This is a PDF file of an unedited manuscript that has been accepted for publication. As a service to our customers we are providing this early version of the manuscript. The manuscript will undergo copyediting, typesetting, and review of the resulting proof before it is published in its final form. Please note that during the production process errors may be discovered which could affect the content, and all legal disclaimers that apply to the journal pertain.

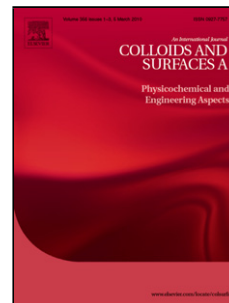

Experimental studies on the detachment of multi-walled carbon nanotubes by a mobile liquid interface

M.J. Hokkanen^{a,1}, S. Lautala^a, E. Flahaut^b, M. Ahlskog^{a,*}

^a*University of Jyväskylä, Department of Physics and Nanoscience Center, P. O. Box 35, FI-40014 University of Jyväskylä, Finland.*

^b*CIRIMAT, Université de Toulouse, CNRS, INPT, UPS, UMR CNRS-UPS-INP No. 5085, Université Toulouse 3 Paul Sabatier, Bât. CIRIMAT, 118, route de Narbonne, 31062 Toulouse Cedex 9, France.*

Abstract

Retention and detachment of colloidal particles from surfaces is often considered only in terms of spontaneous chemical dispersion when the surface is already fully submerged. Nevertheless, interfacial processes, where the particles are caught on a mobile liquid contact line by capillary effects are ubiquitous. Theoretical description of such interfacial processes exist for spherical microcolloids, while for anisotropic shapes the literature is limited. Arc-discharge synthesized multiwalled carbon nanotube (MWNT) material contains besides the very anisotropic tubes also irregular amorphous carbon particles (ACP) that both are strongly hydrophobic. As a water-air-solid contact line is swept over a deposition of MWNT material on a hydrophilic substrate, it causes selective detachment of the spherical ACPs over the one dimensional MWNTs. In this work we investigate the detachment process and the balance between the surface tension force and adhesive forces. Our results show that on hydrophilic substrates the surface tension force of the liquid interface dominates over adhesion, sweeping away most of the material. However, clean MWNTs oriented perpendicular to the contact line are able to resist detachment. On the other hand, on hydrophobic surfaces adhesive forces dominate, possibly via the hydrophobic interaction. We discuss these results with conventional models of capillarity and adhesion, including the van der Waals force and the electrostatic double layer interaction. However, a fully satisfactory analysis will require e.g. computational modelling of the problem.

Keywords: carbon nanotube, contact line, surface tension, wetting, surface chemistry, hydrophobic interaction

PACS: 68.08, 82.65

*Corresponding author

Email address: markus.e.ahlskog@jyu.fi (M. Ahlskog)

¹Present address: Aalto University, School of Electrical Engineering, Espoo, Finland.

1. Introduction

The detachment of nano- and microscale particles from solid surfaces to liquids is an intricate phenomenon when it occurs at the liquid-air-solid contact line [1, 2], a.k.a the wetting line. In certain conditions, the passing of the contact line over the solid surface may result in significant removal of particles by the surface tension of the liquid interface, i.e. capillary effects, rather than detaching when fully immersed in the liquid (surface-to-bulk liquid scenario). This phenomenon has been relevant in a few of the applied sciences. Examples are particle separation in mining industries [3], particle transport and trapping in environmental sciences [1], and in the cleaning processes of the microelectronics industry [4, 5, 6]. These conventional areas of technology are being complemented by the emerging field of nanotechnology, which brings forward new nanoscale particles whose interaction with capillary forces are an important topic as well [7, 8].

The topic is also important as a complex scientific problem, in which the capillary forces, primarily influenced by the wetting of the particles, compete with particle-substrate adhesive forces. Fundamental studies of the problem have been few, since progress on the experimental side has largely been dependent on technical development in experimental nanoscience. Carbon nanotubes (CNT) offer in principle a magnificent test bed for experimental studies in this field, as they can be inert or functionalized, long or short, flexible or rigid. A few experimental works have been reported that involve in some way CNTs interacting with a liquid contact line [8, 9, 10], but in all of these the main goal has been something else than research on the issue of CNT interaction with the liquid interface.

In practice, synthesis and processing conditions impose severe limits on the kinds of experiments that currently are feasible, but future progress should widen these limits. Arc-discharge synthesized multiwalled carbon nanotube (MWNT) material has tubes of high quality [11], but also plenty of synthesis-born carbon debris, which consists of nano- and microscale amorphous carbon particles (ACP). In previous work, we have reported on the detachment of MWNTs and debris particles from spin coated depositions by surface tension forces at the propagating contact line of water [12]. Very interestingly, the detachment process, illustrated schematically in Figure 1, was found to be selective between the MWNTs and the debris particles, tending to leave the former on the surface. This selectivity has been applied for on-chip purification of arc-discharge MWNT material [13], which is demonstrated in the inset of Figure 1, that shows on a MWNT deposition an optical image of the boundary between purified and untreated regions.

Apart from our work, the detachment of CNTs in general has to our knowledge only been considered in the surface-to-bulk liquid scenario [14, 15]. The standard description of detachment in that case involves the DLVO theory of particle adhesion, that combines the ever-present van der Waals and the repulsive electrostatic double layer interactions [16]. In addition, the hydrophobic interaction can be the dominating adhesive force in some cases [17]. These ad-

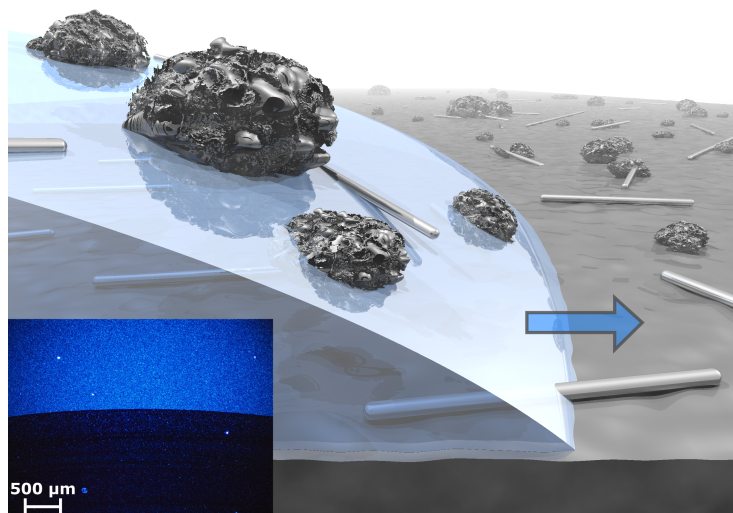

Figure 1: Schematic illustration of a water interfacial contact line moving over a deposition consisting of clean MWNTs and ACPs (amorphous carbon particles) as well as MWNTs with ACPs solidly attached. The debris particles are captured by the surface tension and are suspended at the liquid surface, while some clean MWNTs are retained on the surface. Inset: dark-field optical micrograph demonstrating the effect on a MWNT deposition; The lower dark region corresponds to depopulation of coarse debris particles up to the dark/bright boundary where the contact line motion halted. The upper region is untouched and thus has debris particles that effectively scatter light and so appears bright.

hesive attractive forces oppose the surface tension of the liquid interface when particles are affected by a mobile contact line. The retention or detachment of the clean MWNTs is interesting from a fundamental viewpoint as an indicator of the relative strength of the surface tension force and the adhesive forces between the nanotube and the substrate. As for applications of such research, in environmental sciences for example, the detachment of CNTs by capillary forces in aqueous surroundings will be a very important issue if and when CNTs will be used on a large scale [15, 18].

In this work, we report on experimental studies of the detachment behavior of CNTs, and discuss in terms of simple models the forces and interactions included in the process. We use an experimental procedure, improved over our previous work [13], with a flow chamber (Fig. 2a) that enables us to modify the chemical composition of the immersion liquid in terms of acidity and ionic strength, and thus to vary the effective particle adhesion. Moreover, we have extended our previous studies of arc-discharge MWNTs with double-walled carbon nanotubes (DWNT) grown via chemical vapour deposition (CVD), a material which is closer to the type that currently are developed for mass-production.

2. Experimental

For the majority of the experiments, we use arc-discharge grown, commercially produced MWNTs (Sigma-Aldrich). In addition, in a few experiments CVD-grown DWNTs were used [19]. The DWNTs had been washed in concentrated HCl following the synthesis in order to remove the catalytic material without functionalizing the tubes. Both CNT materials were used by us as-received. The CNT samples were spin coated from dispersion in 1,2-dichloroethane on thermally oxidized silicon substrates (“Si chip”), which were carefully pre-cleaned and treated with oxygen plasma to make them hydrophilic. The Si chips can also be made hydrophobic [13].

In the previous work [13], the Si chip with the MWNT deposit was slowly immersed in a test tube with water, which is now replaced with a flow chamber, illustrated in figure 2a. Aside from pure water, solutions of KCl and HCl were used, to adjust ionic strength and the pH-value. The flow chamber is first filled up with the liquid of choice, and the sample is then immersed using an automated tri-axial stage. Once the Si chip is completely submerged, the chamber is rinsed with clean water from a separate reservoir for several minutes, until the entire volume of the immersion liquid has been flushed away. Finally, the chip is recovered, and dried under nitrogen gas. The flow chamber brings about two benefits: rinsing ensures that the debris detached from the sample chip to the water surface is not re-deposited during the retraction step, and that chemical residues are also prevented from adhering.

In our assay, we tested four samples for each immersion liquid (water, KCl, and HCl) and three different immersion velocities. The aqueous solutions of KCl and HCl had the concentrations 1 M and 0.01 M (pH = 2) respectively, and the immersion velocities were 1, 0.1 and 0.01 mm/s. The velocity in the sample withdrawal phase was fixed at 1 mm/s. The extent of detachment of MWNTs and ACPs was evaluated using dark-field optical microscopy and atomic force microscopy (AFM), with the latter applied for quantitative analysis. More details of the sample preparation, experiments and image analysis are available in the supplement.

3. Results

Figure 3 shows on a typical sample chip with arc-discharge MWNT material deposition, AFM images taken of the same location before and after immersion. The images clearly reveal the effective selective removal of debris particles – ACPs and ACP-covered MWNTs – over clean MWNTs, as well as the tendency of the moving contact line to detach especially those MWNTs oriented parallel to it. The quantitative analysis of the total number of such images is summarized in Figs. 4 and 5. In Fig. 4 we see that with a slow immersion velocity, a relative reduction of close to 90 % can be reached among the irregular ACPs, while the detachment of clean MWNTs is much smaller. There is also a size dependence in the removal of ACPs, which exist in the size range from nanometers to microns; the larger the ACP is, the more likely it is removed

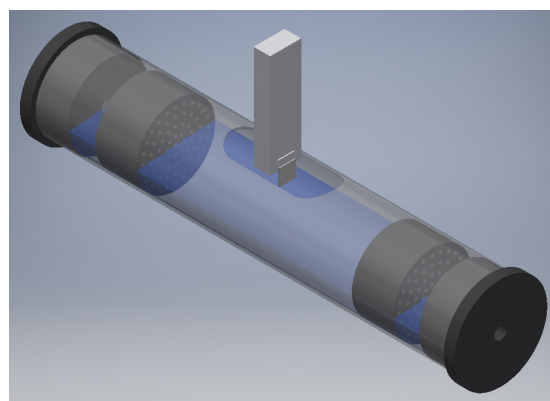

(a)

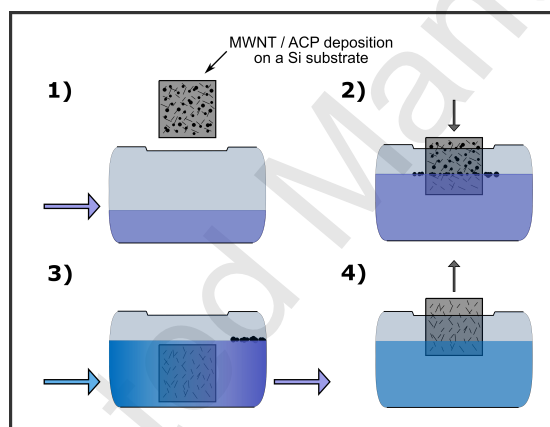

(b)

Figure 2: Scheme of the procedure to sweep a water-air-solid interfacial contact line over a CNT deposit on a Si chip, illustrated in fig. 1. (a) The flow chamber utilized in the experiments, with the Si chip and its support in the center. The left-hand end has an inlet that connects to separate reservoirs for immersion and rinsing liquids, while the outlet is at the right-hand end. (b) The immersion sequence: (1) filling the chamber with liquid; (2) the Si chip is immersed vertically; (3) With the chip fully submerged, the chamber is rinsed; (4) Recovery of the sample.

from the surface. A quantitative analysis of the size dependence is presented in the Supplement. An analysis of the orientation dependence of the unremoved MWNTs is presented in Fig. 5, which shows the number of detached MWNTs as a function of their (pre-immersion) orientation with respect to the liquid contact line. Very evident is the strong tendency of those tubes to remain that are perpendicular to the contact line as it sweeps over them.

We recall that all the results in this work apply to hydrophilic surfaces. As we have reported previously [13], on hydrophobic surfaces the mobile water interface has no effect on the MWNT deposition.

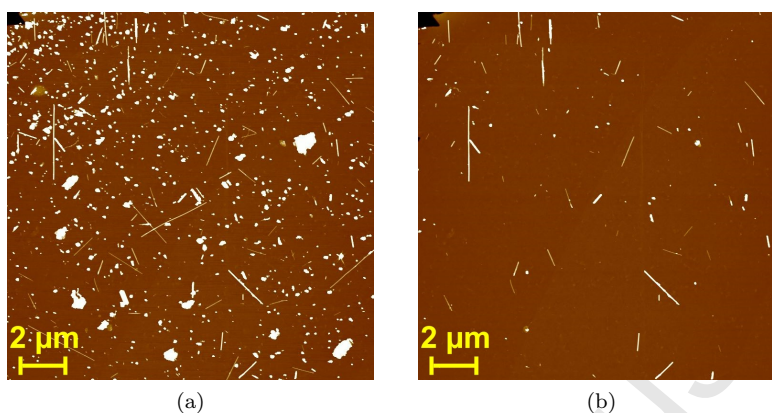

Figure 3: AFM image frames ($17\ \mu\text{m} \times 17\ \mu\text{m}$) captured (a) before and (b) after the immersion process on a typical arc-discharge MWNT sample.

To return to Fig. 4, it demonstrates a clear dependence of the detachment on interface velocity for all three liquids (plain ultrapure water, 1 M KCl solution and $\text{pH} = 2$ 0.01 M HCl solution). Comparing these, it is suggested that the detachment for the acidic HCl solution is slightly better than for the plain water for velocities above $0.01\ \text{mm/s}$, and this applies for both ACPs and MWNTs. For the ionic KCl solution, no clear difference can be seen despite its strong concentration.

AFM images of the experiments on CVD-grown DWNT material are shown in Fig. 6. The initial deposition (Fig. 6a) differs from the arc-discharge MWNT deposition (Fig. 3a) by having much less of irregular debris particles. Also, the CVD-DWNTs are longer and more flexible, and thus have a strong tendency to interconnect even at low dispersion concentrations. In Fig. 6, some DWNT-bundles can also be seen, most likely resulting from limited dispersibility of the material. Qualitatively, comparison of the AFM images shows familiar cleaning behavior: debris particles and DWNT-bundles are vacated efficiently from the deposition much like from a MWNT sample. While the number of DWNTs that are detached in the process is clearly pronounced, some individual tubes are still retained in the post-immersion frame (Fig. 6b).

Finally, we note that the flow chamber concept works well, as all the surfaces are uniform following the immersion treatments in the different liquids. No excessive re-deposition occurred, as was the case in the previous approach [13]. The key point is to ensure that no debris or chemical residues exist on the meniscus that adheres on the hydrophilic surface during the sample retraction, and this is best achieved by sufficient rinsing of the flow chamber with clean water prior to recovery.

4. Discussion

The central experimental results can be summarized as:

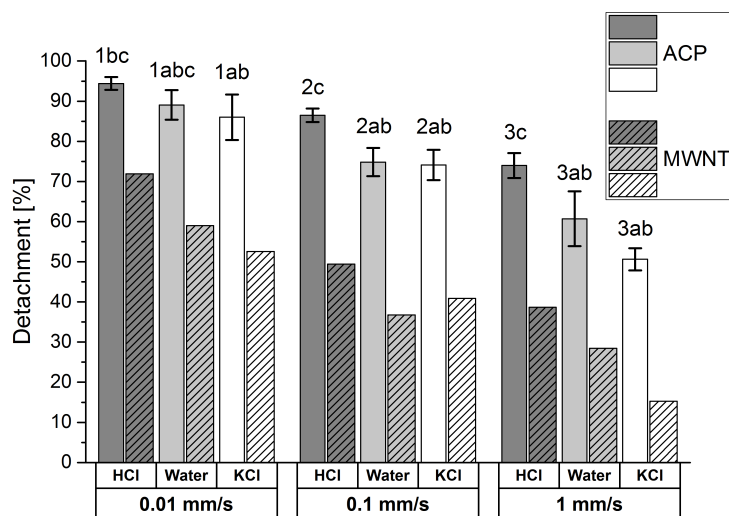

Figure 4: Bar chart summarizing the results of our experiments on detachment of MWNTs and the ACPs in response to interfaces of plain water, 1M KCl solution and 0.01M HCl solution (pH = 2) with three different immersion velocities. The error bars show the standard deviations among the samples. ANOVA-classifications are indicated above the bars for the detachment of ACPs. Numerals refer to the comparison of different immersion velocities for a given immersion solution, while letters point to the comparison of the different solutions for a given velocity. It can be seen that different immersion velocities give systematically rise to statistically significant differences in particle detachment regardless of the immersion solution, while the differences between the solutions are typically not meaningful

- The effect depends radically on the hydrophilicity of the surface [12, 13].
- Clean MWNTs oriented perpendicular to the contact line are less likely to be removed (Fig. 5).
- The removal efficiency is size- and velocity dependent (Supplementary Fig. 3, and Fig. 4).
- Chemical modification (ionic strength, pH) of the water has little effect on particle detachment (Fig. 4).

On an empirical basis, it is obvious that the surface tension force at the contact line dominates over adhesion on the hydrophilic surface, and is responsible of the selective detachment of ACPs over clean MWNTs. The main focus of our interest is to obtain a rudimentary understanding of the different forces that lead to this selectivity in the process. Before our analysis in the next section, we state a few general remarks about this work.

Firstly, as opposed to nearly all works that include processing or experimentation with CNTs on water or other liquid surface, our arc-discharge synthesized MWNTs have walls that are reasonably close to undisturbed graphitic layers, i.e. they should be fully hydrophobic and have few ionizable defect sites. Typically, experiments with CNTs at water surfaces have been made on highly

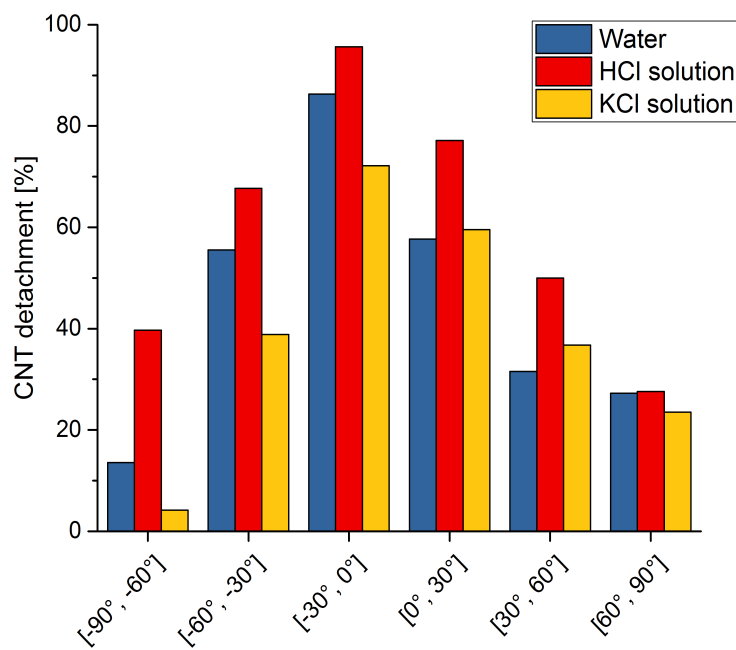

Figure 5: Bar chart summarizing the results of our experiments on orientation dependence of detachment of MWNTs in response to interfaces of plain water, 1 M KCl solution and 0.01 M HCl solution (pH = 2) with three different immersion velocities.

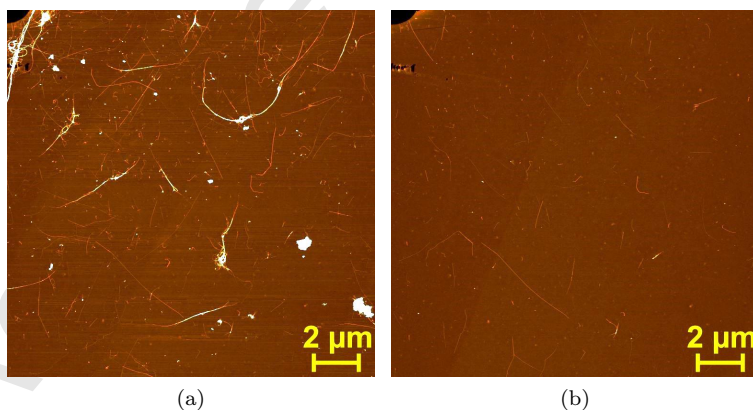

Figure 6: AFM image frames (17 μm × 17 μm) captured (a) before and (b) after the immersion process of Fig. 2b on a CVD-grown DWNT sample.

defective CVD-grown tubes, and/or include processing steps that renders the tubes defective [8, 9, 10]. Moreover, the CNTs are commonly made soluble via functionalization of the outer layer, which ensures that those CNTs are very different from ours with respect to surface properties.

Secondly, the 1D and nanoscale character of the MWNTs is clearly a factor as the immersion process tends to leave on the surface particularly MWNTs that are oriented perpendicularly to the contact line, as was illustrated in Figure 1. However, our analysis is dependent on existing analytical expressions for capillary and surface-particle interactions, which mostly apply for spherical, macroscopic bodies. In accordance to the result shown in Fig. 5, it is intuitively rather comprehensible that the capillary force of the liquid interface has a weaker interaction with a perpendicularly oriented tube than with one oriented parallel to it. But for a rigorous analysis, it is easily seen how the complexity of the problem becomes very tedious and would perhaps require computational modeling as this particular but obviously important case is considered. Therefore our analysis in the next section will be mostly qualitative.

4.1. Evaluation of detachment forces

As was stated above, we discuss here the forces relevant to our experiments within the established models developed for spherical particles. The particle that is overtaken by the advancing contact line is subject to the surface tension force, that push on the particle, and adhesive forces that resist any movement. We consider as the latter DLVO-type surface adhesion, characterized as a sum of vdW- and electrostatic double layer interactions [16], and the hydrophobic interaction.

4.1.1. The surface tension force

A theoretical treatment of surface tension forces involved in detachment of spherical microcolloids on a surface has been originally developed by Leenaars & O'Brien [4, 5]. If the particle is small, other forces such as gravity and buoyancy can be ignored.

One starts with a simplified scenario for the derivation of the surface tension force maximum for a mobile liquid interface. Figure 7a shows schematically a spherical particle with radius R at liquid surface that rises axisymmetrically at gradual pace. The contact angles of the particle and the substrate are θ and α , respectively. The local depression of the interface results in a surface tension force onto the particle, that is oriented vertically due to the symmetry.

As per to [4], the surface tension force F_γ in Fig. 7a is

$$F_\gamma = 2\pi R\gamma \sin\phi \sin(\theta - \phi), \quad (1)$$

where γ is the surface tension, and ϕ a fill angle that determines the momentary position of the meniscus on the particle. The fill angle ϕ gets all possible values during the wetting process. The maximum of the surface tension force can thus be found via differentiation with respect to the free parameter ϕ ; this yields $\phi = \theta/2$.

The more relevant case of a laterally advancing interface (imbibition) is illustrated in Fig. 7b. The lateral progression of the contact line brings about an additional boundary condition: the meniscus must bind to the surface with the contact angle α at the far side of the particle, which tilts the surface tension

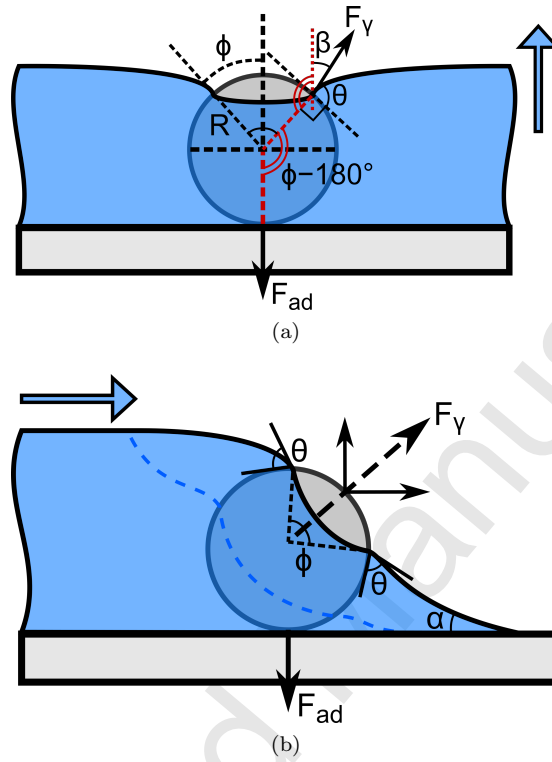

Figure 7: (a) Axisymmetric wetting of a spherical particle at liquid surface. (b) Laterally propagating meniscus in the case of imbibition (advancing contact line). The blue dashed line represents the interface at an earlier moment.

force vector F_γ . The detachment of a particle from the surface is seen to result as the vertical component of this force overcomes adhesion forces. The maximum value of the vertical component is expressed as [1]:

$$F_\gamma = 2\pi R\gamma \sin^2\left(\frac{\theta}{2}\right) \cos \alpha \quad (2)$$

Although eq. 2 was derived for a spherical microcolloid, it helps to qualitatively explain a number of the observed effects in our process. Firstly, the capillary force scales linearly with R , while the adhesion force, to be discussed below, can be assumed to have a weaker dependence on ACP size. Therefore the more efficient removal of larger ACPs in favor of smaller ones is understandable. On the other hand, a clean, smooth nanotube will have a much larger contact area/volume ratio that makes them more resilient to detachment relative to the irregularly shaped ACPs.

A second observation has to do with the hydrophilic/hydrophobic properties. The force in eq. 2 is maximized for maximal θ and minimal α , corresponding to the contact angles to hydrophobic particles and hydrophilic substrates, respec-

tively. Arc-discharge MWNTs should be highly hydrophobic, as are the ACPs, and the silica surface in our experiment is hydrophilically treated. In agreement with our experiments, most of the MWNT material, especially the ACPs are in that case removed during the immersion process, while in earlier experiments with hydrophobic surfaces [12, 13], there is practically no removal.

Equation 2 does not include dynamics, while our experiments exhibit a velocity dependence of the detachment (Fig. 4): as the motion of the interface slows down, the degree of detachment increases. As we relate our work to that of others, similar qualitative tendency has been demonstrated in the experiments on homogenous spherical microcolloids [1, 20, 21]. On the scale of individual particles, slower wetting promotes the formation of a well-defined three-phase contact line resulting in a statistically greater degree of detachment in an ensemble of particles [20]. In the work by Leenaars & O'Brien, the possibility of a more direct dependence on the interface velocity due to reactive viscous forces was brought up [5], but more recently it has been argued that this should not take place for submicron-scale colloids at such moderate interface velocities [21].

For situations of flow in conventional fluid mechanics, although in our nanoscale settings not necessarily warranted, the capillary number is used to obtain rough guidelines for the relative importance of capillarity and viscosity, and the Reynolds number to predict, for example, the onset of turbulence. We estimate with the immersion speeds that we employ that the capillary number $< 10^{-5}$ and the Reynolds numbers < 1 . These numbers are that low, that they suggest capillary forces to dominate over viscosity and that the flow is non-turbulent. We conclude that the surface tension force of water is able to remove hydrophobic carbon particles on hydrophilic surfaces. The main factors behind the selectivity of the process are the size dependence of the interaction and the orientation of the tubes.

4.1.2. Adhesion forces

The vertical detachment force by the surface tension is opposed by adhesion. The omnipresent unretarded van der Waals interaction, has the following well-known expression for a spherical particle with radius R ,

$$F_{\text{vdW}} = \frac{AR}{6H^2}, \quad (3)$$

where A is the composite Hamaker constant of the substrate-medium-particle system, and H the surface-particle distance [22]. For a tubular particle, a similar expression can be derived [22]:

$$\frac{F_{\text{ad}}}{L} = \frac{AD^{1/2}}{16H^{5/2}}, \quad (4)$$

for diameter D and length L . Also, several retarded expressions that limit the attraction at higher separations H have been proposed [23].

We may attempt to compare the Van der Waals adhesion force with the capillary force for both ACPs and MWNTs based on eqs. 2, 3 and 4. We take the particle-liquid contact angle as $\theta \approx 90^\circ$ from measurements of sessile water droplet on graphene [25, 26], and the surface-liquid contact angle $\alpha \approx 0^\circ$ for the fully wetting case. This means that the trigonometrical factors in eq. 2 effectively become unity. The estimates for adhesive force are subject to some uncertainty with the appropriate values for the Hamaker constant A and the separation H . However, A is generally taken as 10^{-21} for solid bodies interacting in water; here, we use a value of $2.6 \cdot 10^{-21}$ J that has been measured for Buckminsterfullerene on quartz in a liquid environment [24]. For H we use a typical interatomic spacing ~ 0.2 nm.

For small ACPs, a smooth sphere can be a good model, and for that both the capillary and the van der Waals forces are linear functions of R , whereby their ratio is independent of it. With the assumptions above, this ratio becomes:

$$\frac{F_\gamma}{F_{\text{vdW}}} = \frac{12\pi\gamma H^2}{A} \sim 10, \quad (5)$$

This numerical estimate thus suggests that the surface tension of a mobile liquid interface can be sufficient to detach all small particles from the surface.

For the main topic of this work, the nanotubes, similar size-independent expressions can not be constructed and we must contend with, for example, by considering a typical MWNT with diameter $D = 10$ nm. We estimate the capillary force in the two extreme cases when the tube is either perpendicular or parallel to the advancing liquid interface. In the perpendicular case we may insert $R = D/2$ into eq. 2. For the parallel arrangement, the length of the interface line $2\pi R$ can be thought to approach the length of the tube L , and thus the detachment force is expected to grow by an approximate factor L/R . The adhesion force of the tube is given by eq. 4, which gives $F_{\text{vdW}}/L \sim 3 \cdot 10^{-2}$ N/m. For tubes lying perpendicular to the interface, the adhesion becomes comparable to the detachment force maximum when their length is in the order of 100 nm; for MWNTs typical on our samples with $L \sim 1$ μm , strong retention is then expected. But as the angle between the tube axis and the liquid interface line becomes smaller, the tendency of the tubes to detach increases independent of their length L , and for the extreme parallel case, detachment is expected to dominate, which is in agreement with our experimental results.

For the irregularly-shaped ACPs on our samples, the particle-surface contact area increases much more slowly with R than is apparent; they make mechanical contact with the substrate only at different local surface asperities, similarly as when the microscopic origin of friction between two solid bodies is considered [27]. Moreover, the strong dependence of the van der Waals attraction on particle-substrate separation [16] has the effect that parts of larger ACPs

outside the local surface asperities do not contribute to adhesion. Therefore, in practice the total adhesion force should grow much more weakly than linearly with R for the ACPs. This is expected to contribute to the frequent detachment of large particles, which is implied in the size-resolved detachment statistics (Supplementary Fig. 3).

The generalized DLVO adhesion energy is the sum of the van der Waals adhesion and the electrostatic double layer interaction:

$$W_{\text{DLVO}} = W_{\text{vdw}} + W_{\text{el}} \quad (6)$$

Assuming an electrolyte that contains only one kind of ionic species, the electrostatic double layer interaction energy can be expressed as [20, 28]:

$$W_{\text{el}} = 64\pi\epsilon R \left(\frac{kT}{ze}\right)^2 \times \left[\tanh\left(\frac{ze\psi_{\text{col}}}{4kT}\right) \right] \left[\tanh\left(\frac{ze\psi_{\text{sub}}}{4kT}\right) \right] \exp(-\kappa H), \quad (7)$$

$$\kappa = ze\sqrt{\frac{n}{\epsilon kT}}, \quad (8)$$

where n is the ion concentration, z the ion valence, ψ_{col} and ψ_{sub} the surface potential of the particle and the substrate (typically taken as their ζ -potentials), respectively. κ is the inverse Debye-Hückel length. The other parameters have their usual meanings.

The role of W_{el} can be probed by either changing the electrolytic property of the medium or the ionization state of the surface or the colloid [16]. The effect of the ionic strength of an electrolyte solution factors directly into eq. 7: the greater the salt concentration, the shorter the Debye length κ^{-1} , and weaker the double layer. We would thus expect a greater degree of particle retention in ionic environments as the energy barrier separating the primary and secondary minima of the DLVO adhesion curve grows thin. However, in our experiments, we see hardly any systematic effect with the 1 M KCl solution, which should be sufficient to fully suppress the barrier [16].

In a previous experiment that dealt with retention and detachment of carboxylated CNTs in bulk electrolytes, a systematic reduction of CVD-grown MWNT detachment was also seen in low-pH environment [14]. The effect was attributed to dissociation of the chemical groups adhered both on the substrate and the nanotubes. In our case, opposing behavior is seen: the detachment due to the interface is enhanced in low-pH environment. However, as we pointed out, our arc-discharge MWNTs are of high quality, with a relatively low level of defects or associated molecular groups. Therefore their surface potential is unlikely to change drastically in environments of different pH. On the other hand, the surface chemistry of the substrate is highly hydrophilic with hydroxylation of the silica, and therefore some effect upon the change of pH is expected.

The essential conclusion from these arguments is that W_{el} is only weakly contributing to the DLVO adhesion between the MWNT and the Si surface, and that this is primarily due to the weak degree of ionization of the arc-discharge MWNT in the aqueous environment. On a hydrophilic surface the net adhesion is then mainly by the van der Waals part W_{vdw} .

4.1.3. The hydrophobic interaction

Next, we shift the attention to the fact that on a hydrophobic surface the outcome of the experiments is drastically different as in practice no detachment takes place. We can crudely estimate the relative magnitudes of hydrophobic and DLVO interactions, in the case of hydrophobic surfaces. For the hydrophobic interaction this simple expression has been proposed [29]:

$$W_h = \gamma H_y \exp\left(-\frac{H}{D_H}\right), \quad (9)$$

where H_y is the so called Hydra parameter, and D_H is decay length (γ and H have same meaning as above). W_h has an upper limit determined by γ [29]. At this limit, with $H_y \sim 1$, and $D_H \sim 1$ nm, the hydrophobic interaction energy for a 10 nm fullerene, as an approximation for a segment of a MWNT, is on the order of 10^{-18} J, while a calculation of the van der Waals interaction for the same fullerene gives an interaction energy on the order of 10^{-21} J. Therefore, the stark difference between the hydrophobic and hydrophilic surfaces can be justified as a consequence of these estimates.

4.2. Detachment of CVD-grown DWNTs

The experiment on CVD-grown DWNTs showed that similar effects work for this type of material as well, since the irregular particulates were successfully removed. However, a lot of the DWNTs detached as well in the process. Of the remaining individual tubes, most are relatively short, and can usually be identified in the pre-immersion images as not overlapping with other tubes.

It is thus suggested that most of the detached DWNTs are part of interconnected networks, while individual tubes that have a lot of contact area with the silicon substrate directly have a better chance to be retained. Given their length and flexible nature, DWNTs are more likely to form densely connected depositions than MWNTs, and to that end it is not surprising that they tend to detach collectively, rather than as individual tubes. However, for thorough understanding of the detachment of DWNTs, additional work needs to be undertaken.

5. Conclusions

In summary, we have presented a refined experimental methodology, with which to study detachment of CNTs (MWNTs and DWNTs) on a hydrophilic surface, due to the surface tension forces of the water-air-solid contact line, and the adhesive forces that resist the detachment. Clear selectivity in detachment is observed, with larger ACP debris particles efficiently detached, while the behavior of MWNTs depend on their orientation with respect to the water contact line, as the perpendicular ones mostly remain on the surface. We have based our understanding of these results on the theory of colloid detachment [4, 5], and on standard theories of particle-surface adhesion. In this picture, the particle is detached if the vertical maximum component of the surface tension

force exerted by the liquid contact line exceeds its surface adhesion. We argued that electrostatic double layer adhesive forces have little effect on the extent of overall particle detachment in these experiments. On the other hand, adhesion via the hydrophobic interaction is thought to be the primary explanation for the fact that no detachment occurs on a hydrophobic surface. The existing theories can thus give a qualitative explanation of the detachment phenomena, but a more refined theory is needed to take into account, for example, the behavior of anisotropic nanoscale particles. We suggest that these problems could be addressed by computational studies.

Acknowledgements

The authors thank Dr. Sami Malola for producing Figure 1, Dr. Tuomas Turpeinen for support with analysis of the AFM images, and Dr. Elina Laurila for assistance with the experiments. M. J. Hokkanen gratefully acknowledges financial support from the University of Jyväskylä graduate school.

- [1] S. Aramrak, M. Flury, J.B. Harsh, Detachment of deposited colloids by advancing and receding air-water interfaces, *Langmuir* 27 (2011) 9985-9993.
- [2] V. Lazouskaya, L. P. Wang, D. Or, G. Wang, J. L. Caplan, Y. Jin, Colloid mobilization by fluid displacement fronts in channels, *J. Colloid Interface Sci.* 406 (2013) 153-159.
- [3] J.E. Saiers, G.M. Hornberger, D.B. Gower, J.S. Herman, *Geophys. Res. Lett.*, 30, 2083 (2003).
- [4] A.F.M. Leenaars, A new approach to the removal of sub-micron particles from solid (silicon) surfaces, in: K.L. Mittal (Ed.), *Particles on surfaces 1: Detection, Adhesion, and Removal*, Plenum Press, New York, 1988, pp. 361-372.
- [5] A.F.M. Leenaars, S.B.G. O'Brien, Particle removal from silicon substrates using surface tension forces, *Philips J. Res.* 44 (1989) 183-209.
- [6] K.A. Reinhardt, W. Kern (Eds.), *Handbook of Silicon Wafer Cleaning Technology*, second ed., William Andrew Inc., Norwich, USA, 2008.
- [7] Deegan, R. D., Bakajin, O., Dupont, T. F., Huber, G., Nagel, S. R., & Witten, T. A. Capillary flow as the cause of ring stains from dried liquid drops. *Nature* **387**, 827-829 (1997).
- [8] C.Y. Khripin, M. Zheng, A. Jagota, *J. Colloid. Interf. Sci.* 330, 2 (2009).
- [9] S. Gerdes, T. Ondarcuhu, S. Cholet, C. Joachim, *Europhys. Lett.* 48, 3 (1999).
- [10] F. Seichepine, S. Salomon, M. Collet, S. Guillon, L. Nicu, G. Larrieu, E. Flahaut, C. Vieu, *Nanotechnology*, 23, 095303 (2012).
- [11] H. Jackman, P. Krakhmalev, K. Svensson, *J. Appl. Phys.* 117, 084318 (2015).
- [12] M.J. Hokkanen, R. Lehto, J. Takalo, J. Salmela, S. Haavisto, A. Bykov, R. Myllylä, J. Timonen, M. Ahlskog, Depletion of carbon nanotube depositions and tube realignment in the spreading of sessile drops, *Colloids Surf., A* 482 (2015) 624-630.

- [13] M.J. Hokkanen, S. Lautala, S. Dongkai, T. Turpeinen, J. Koivistoinen, M. Ahlskog, On-chip purification via liquid immersion of arc-discharge synthesized multiwalled carbon nanotubes, *Appl. Phys. A* 122 (2016) 1–8.
- [14] P. Yi, K.L. Chen, Influence of solution chemistry on the release of multiwalled carbon nanotubes from silica surfaces, *Environ. Sci. Technol.* 47 (2013) 12211–12218.
- [15] P. Yi, K.L. Chen, Release kinetics of multiwalled carbon nanotubes deposited on silica surfaces: quartz crystal microbalance with dissipation (QCM-D) measurements and modeling, *Environ. Sci. Technol.*, 48 (2014) 4406–4413.
- [16] J.C. Berg, *An Introduction to Interfaces & Colloids: The Bridge to Nanoscience*, World Scientific, Singapore, 2010, pp. 547–552.
- [17] M.E. Meyer, K.J. Rosenberg, J. Israelachvili, Recent progress in understanding hydrophobic interactions, *Proc. Natl. Acad. Sci. USA* 103 (2006) 15739–15746.
- [18] L. Zhang, E.J. Petersen, W. Zhang, Y. S. Chen, M. Cabrera, Q. Huang, Phase distribution of ^{14}C -labeled multi-walled carbon nanotubes in aqueous systems containing model solids: clay., *Environmental Pollution*. 166 (2012) 75–81.
- [19] E. Flahaut, R. Bacsá, A. Peigney, Ch. Laurent, Gram-scale CCVD synthesis of double-walled carbon nanotubes, *Chem. Comm.* 12 (2003) 1442–1443.
- [20] P. Sharma, M. Flury, J. Zhou, Detachment of colloids from a solid surface by a moving air-water interface, *J. Colloid Interface Sci.* 326 (2008) 143–150.
- [21] C. Gómez Suárez, J. Noordmans, H.C. van der Mei, H.J. Busscher, Removal of colloidal particles from quartz collector surfaces as stimulated by the passage of liquid-air interfaces, *Langmuir* 15 (1999) 5123–5127.
- [22] M.B. Ranade, Adhesion and removal of fine particles on surfaces, *Aerosol Sci. Tech.* 7 (1987) 161–176.
- [23] J. Gregory, Approximate expressions for retarded van der waals interaction, *J. Colloid Interface Sci.* 83 (1981) 138–145.
- [24] X. Ma, B. Wigington, D. Bouchard, Fullerene C_{60} : Surface Energy and Interfacial Interactions in Aqueous Systems, *Langmuir* 26 (2010) 11886–11893.
- [25] J. Rafiee, X. Mi, H. Gullapalli, A.V. Thomas, F. Yavari, Y. Shi, P.M. Ajayan, N.A. Koratkar: Wetting transparency of graphene, *Nat. Mater.* 11 (2012) 217–222.
- [26] Y.J. Shin, Y. Wang, H. Huang, G. Kalon, A.T.S. Wee, Z. Shen, C.S. Bhatia, H. Yang: Surface-Energy Engineering of Graphene, *Langmuir* 26 (2010) 3798–3802.
- [27] C. Mathew Mate, *Tribology on the small scale*, Oxford University Press, New York, USA, 2008.
- [28] J. Gregory, Interaction of unequal double-layers at constant charge, *J. Colloid Interface Sci.* 51 (1975) 44–51.

- [29] S.H. Donaldson, A. Royne, K. Kristiansen, M.V. Rapp, S. Das, M.A. Gebbie, D.W. Lee, P. Stock, M. Valtiner, J. Israelachvili, Developing a general interaction potential for hydrophobic and hydrophilic interactions, *Langmuir* 31 (2015) 2051–2064.

Accepted Manuscript

MWNT / ACP deposition
on a Si substrate

1)

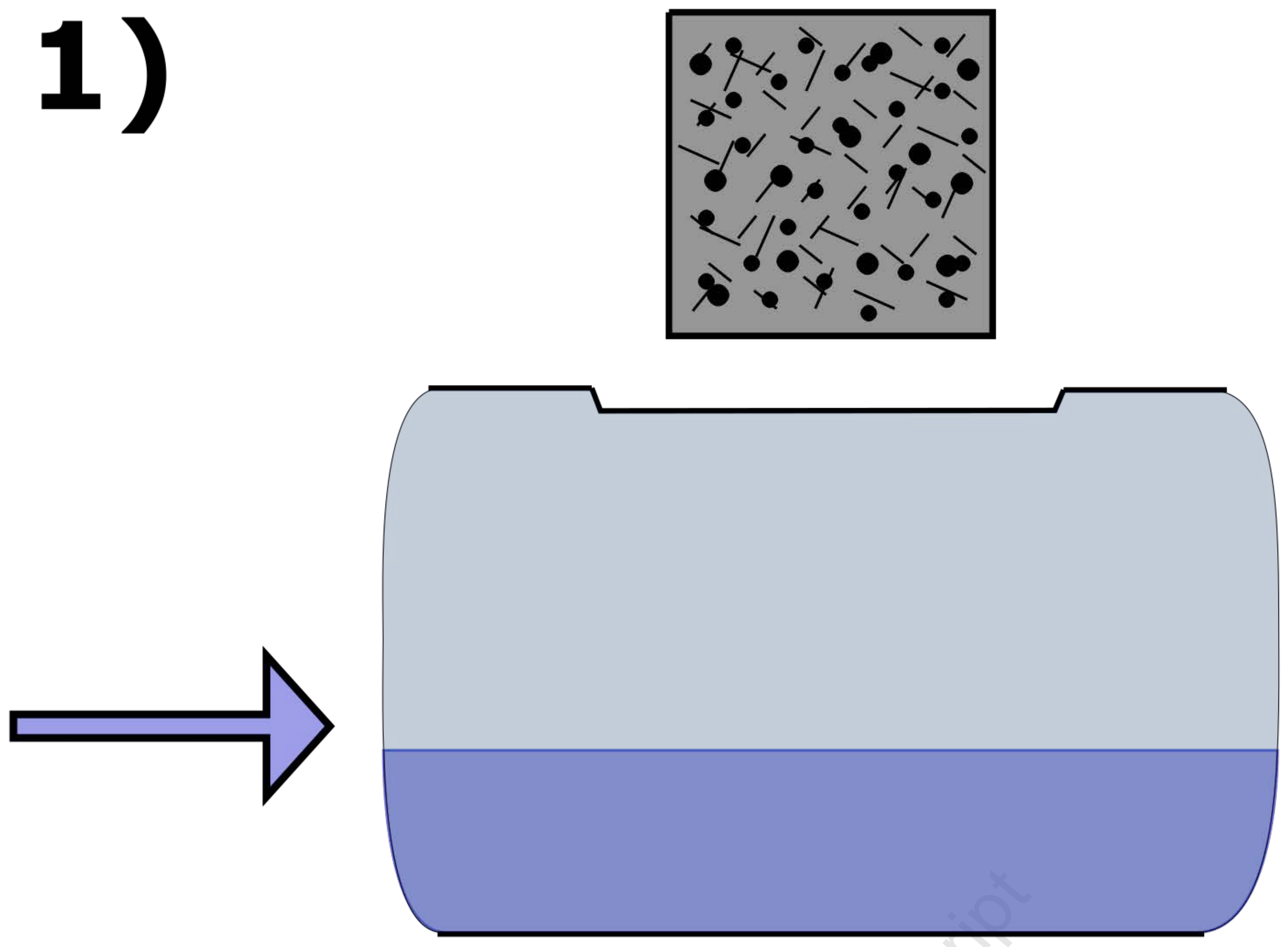

2)

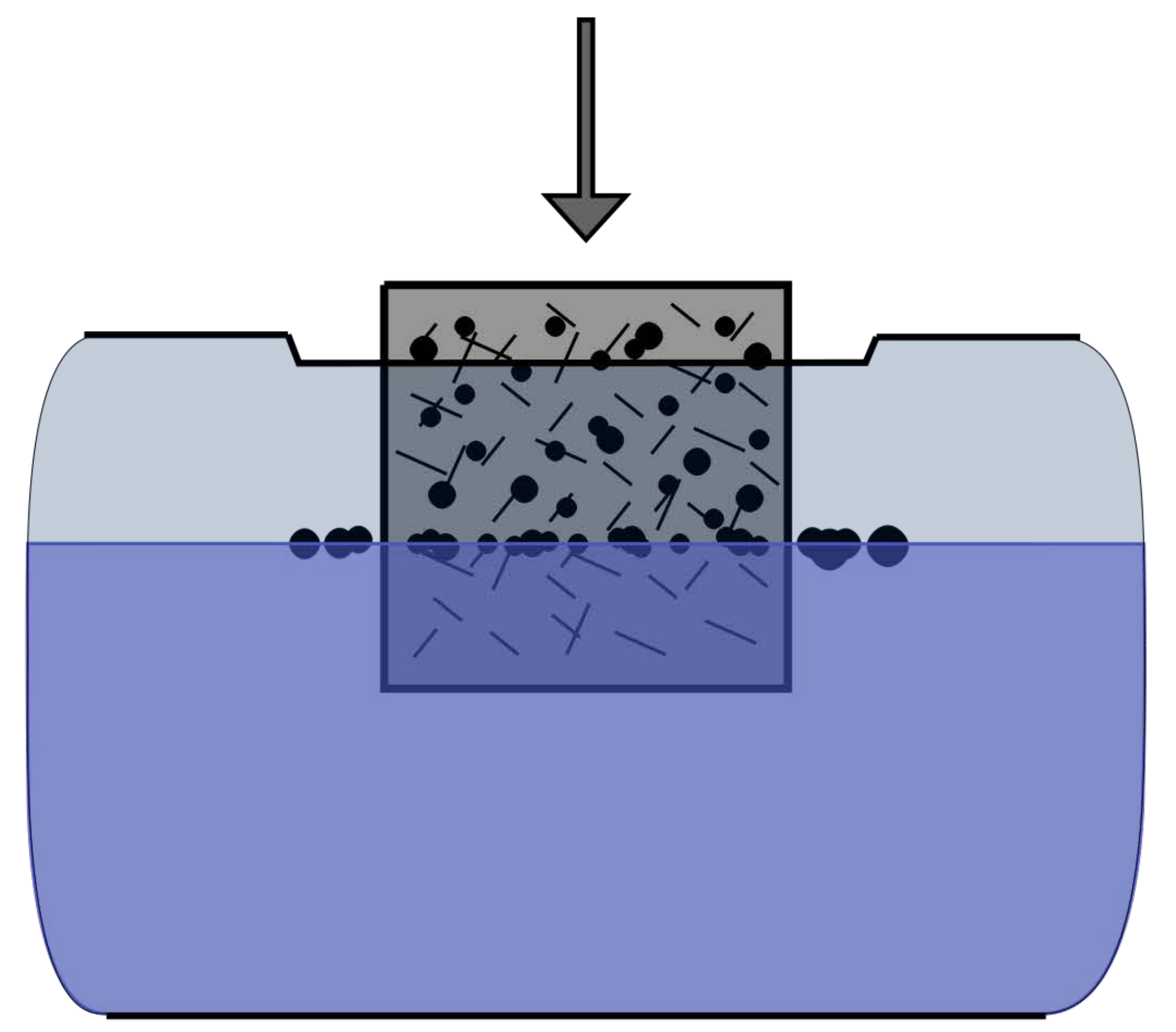

3)

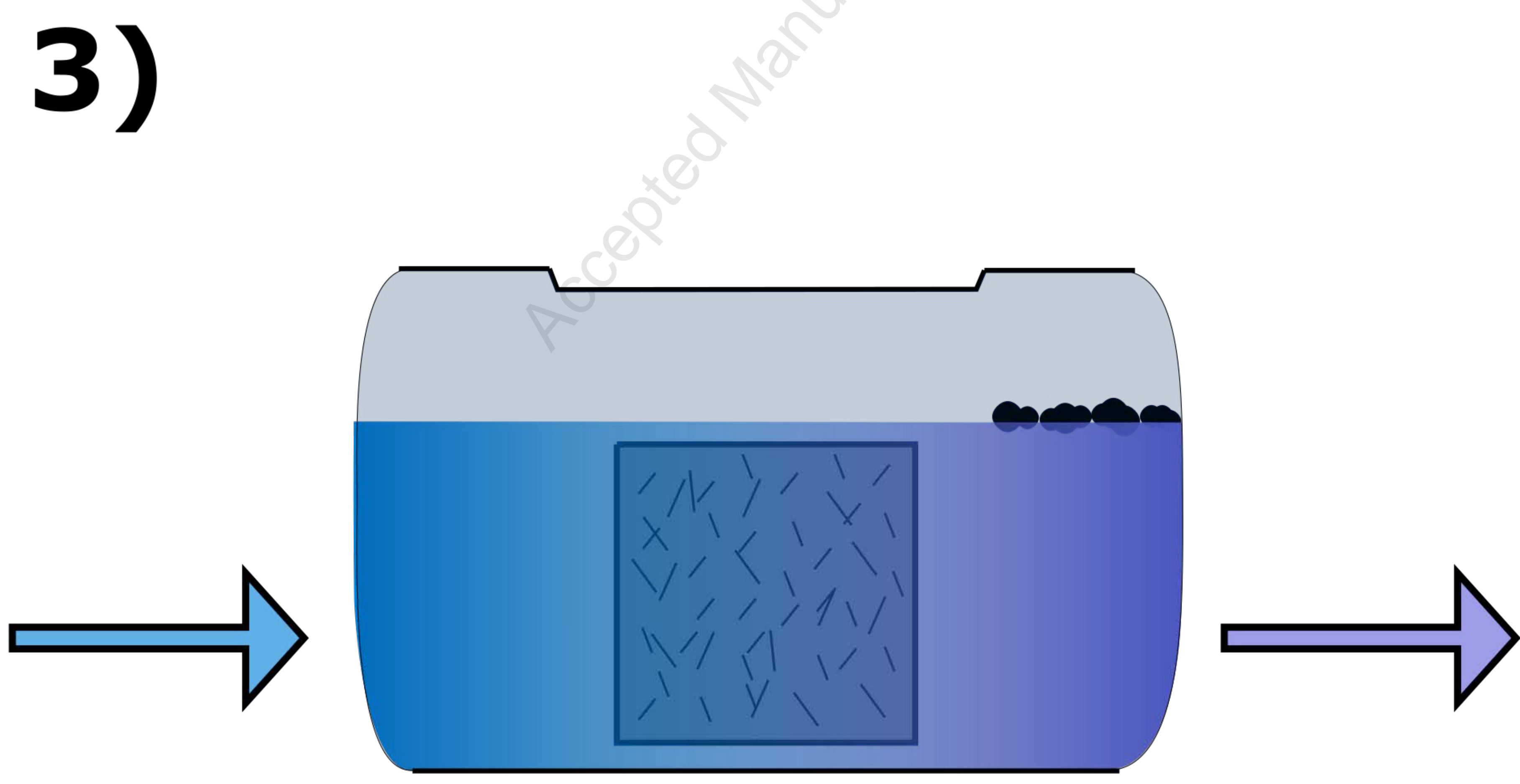

4)

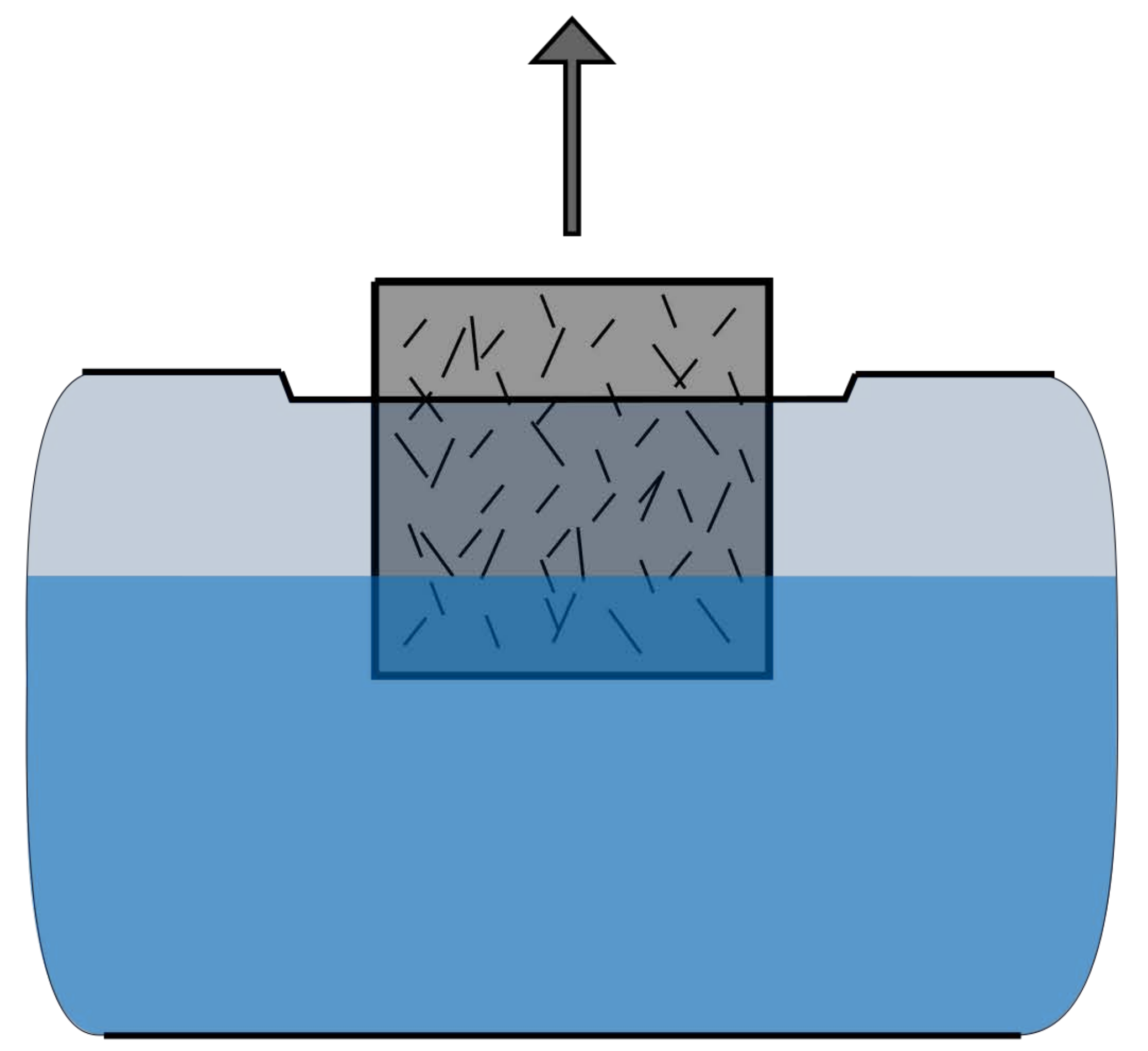

Accepted Manuscript